

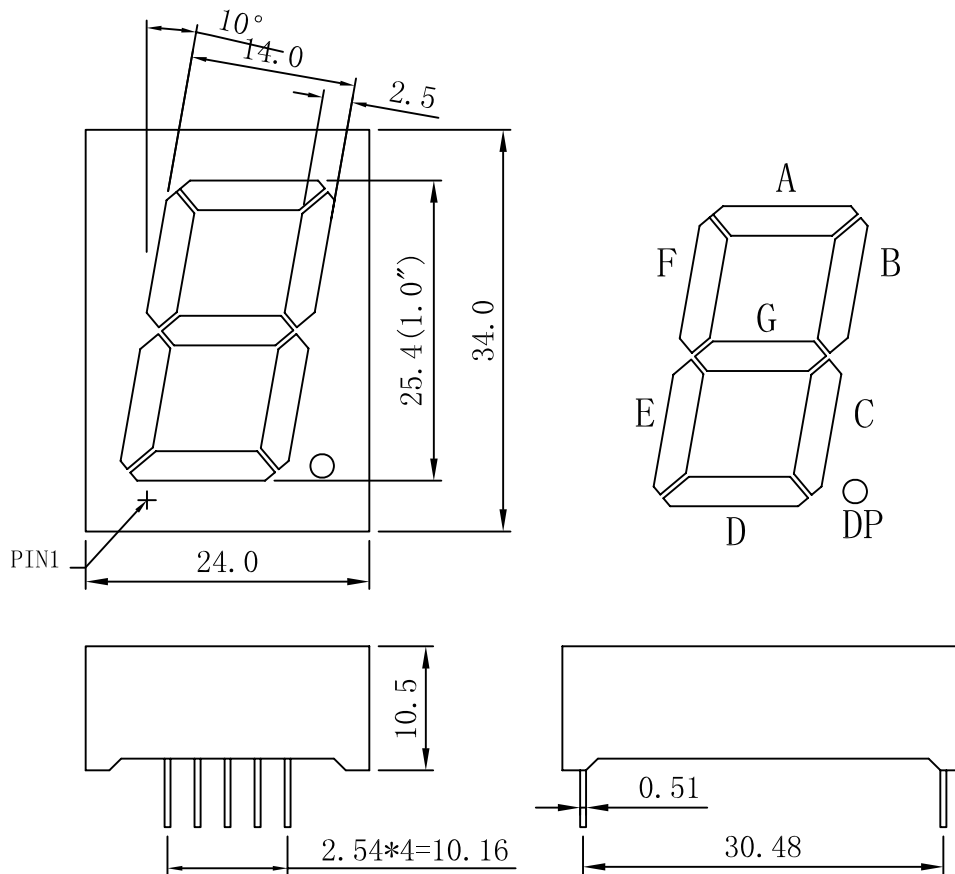

科宏光电(深圳)有限公司
KEHONG OPTO ELECTRONICS (SHENZHEN) CO., LTD.

PACKAGE DIMENSION

KHN11003



CODE A

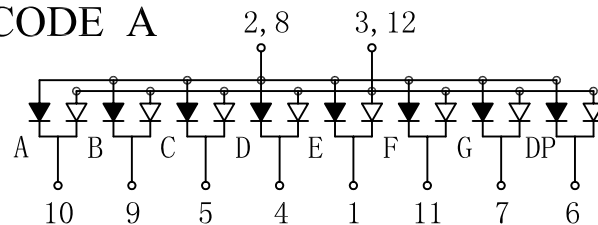

CODE C

