

### Typical Features

- ◆ Wide input voltage range 85-265Vac/120-380Vdc
- ◆ Transfer Efficiency(Typical 83%)
- ◆ Switching Frequency: Jitter frequency 50-60KHz
- ◆ Protections: over current, short circuit, over voltage, under voltage, over temperature, Self-furbish
- ◆ Input and Output highly isolated 3750Vac
- ◆ PCB mounting
- ◆ Plastic Case, conform to UL94V-0
- ◆ Conform to CE standard



### Application Field

**FA6-220SXXD2** Series-----a compact size, high efficient, according to CE regulation power converter offered by Aipu.

It features universal input voltage range, taking both DC and AC input, low ripple, low temperature rise, low power consumption, high efficiency, high reliability, safer isolation.

It offers good EMC performance, EMC and Safety specifications meet international EN55032,IEC61000 standards.

It widely used in industrial, office and civil applications. For harsh EMC environment, the application circuit in the datasheet is strongly recommended.

### Product Named Method

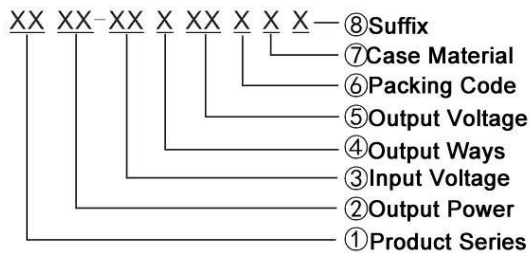

For example:

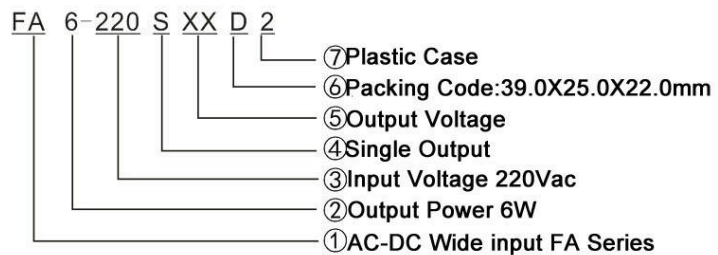

### Typical Product List

Certificate	Model	Input Voltage Range	Output		Max. Capacitive Load	Ripple& Noise 20MHz	Efficiency@ Full Load, Nominal Input Voltage (Typical)
			Voltage	Current			
			Vo1(V)	Io1(mA)			
Meet CE	FA6-220S3V3D2	85V-265Vac 120-380Vdc	3.3	1200	1000	80	66
	FA6-220S3V6D2		3.6	1200	1000	80	72
	FA6-220S05D2		5.0	1200	1000	80	75
	*FA6-220S09D2		9.0	666	1000	120	80
	FA6-220S12D2		12.0	500	680	120	80
	FA6-220S15D2		15.0	400	470	120	81
	*FA6-220S24D2		24.0	250	220	120	83

Note 1: Due to space limitations, above is only a part of our product list, please contact our sales team for more items.

Note 2: "\*" are models under developing.

Note 3: Conform to CE standard, is applying.

**Technical Parameters** Test Condition: Unless otherwise specified, data in the datasheet should be tested under the conditions of inputting nominal voltage, pure resistance rated load and Ta=25°C.

### Input Specification

Items	Operating Condition	Min.	Typ.	Max.	Notes
Input Voltage Range	AC input	85	220	265	VAC
	DC input	120	310	380	VDC
Input Frequency Range	-	47	50	63	Hz
Input Current	115VAC~47Hz	-	149		mA
	230VAC~50Hz	-	73.0		
Input Inrush Current	110VAC~47Hz	-	10	-	A
	230VAC~50Hz	-	20	-	
Recommended External Input Fuse	-	2A~250Vac slow fusing, block form			
Remote Control Terminal	-	-	Not available	-	-

### Output Specification

Voltage Accuracy	Any Load, full voltage range	Vo1	±2.0%
Line Regulation	Nominal Load, full voltage range	Vo1	±0.5%
Load Regulation	20% ~ 100% nominal load	Vo1	±1.0%
Ripple & Noise	20MHz BM full load		
	Vo≤5.0V, ≤80mVp-p	Other ≤120mVp-p	/
	Ripple & Noise tested under twisted-pair method ( See Ripple& Noise Test in the back)		
Turn-on Delay Time	Nominal input voltage	Typical	2000mS
Output Power-off Holding Time			10mS
Output Short Circuit Protection	Self-recovery	Output Switch-off	Hiccup
Output Over Load Protection	≥150% Po	Output Switch-off	Hiccup
Temperature Drift Coefficient	-	±0.03	%/°C

### General Specification

Switching Frequency	50KHz	55KHz typical	60KHz
---------------------	-------	---------------	-------

Operating Temperature	-	Free air convection	-25℃~ +65℃
Storage Temperature	-	-	-40℃ ~ +105℃
Relative Humidity	-	-	10%~90%
Isolation Voltage/Insulation resistance	Input to Output 3750Vac ≤ 3.0mA/1min; Input and Output ≥ 100MΩ (test voltage as DC 500V)		
Safety Standard	-	EN55032, EN61000	
Safety Certificate	-	CE	

### EMC Electromagnetic Compatibility

EMC	EMI	CE	CISPR22/EN55032/EN55024 CLASS B (See Photo 1 for recommended circuit)
		RE	CISPR22/EN55032/EN55024 CLASS B (See Photo 1 for recommended circuit)
	EMS	RS	IEC/EN61000-4-3 10V/m Perf.Criteria B (See Photo 1 for recommended circuit)
		CS	IEC/EN61000-4-6 3Vr.m.s Perf.Criteria B(See Photo 1 for recommended circuit)
		ESD	IEC/EN61000-4-2 Contact ±4KV Air ±8KV (See Photo 1 for recommended circuit)
		Surge	IEC/EN61000-4-5 ±1KV Perf.Criteria B(See Photo 1 for recommended circuit)
		EFT	IEC/EN61000-4-4 ±2KV Perf.Criteria B(See Photo 1 for recommended circuit)
		Voltage dips, short interruptions and voltage variations immunity	IEC/EN61000-4-11 0%~70% Perf.Criteria B
Vibration	10-55HZ,10G,30Min,alongX,Y,Z		
MTBF	2X10 <sup>5</sup> Hrs		
Class of Case Material	UL94 V-0		

### Dimension

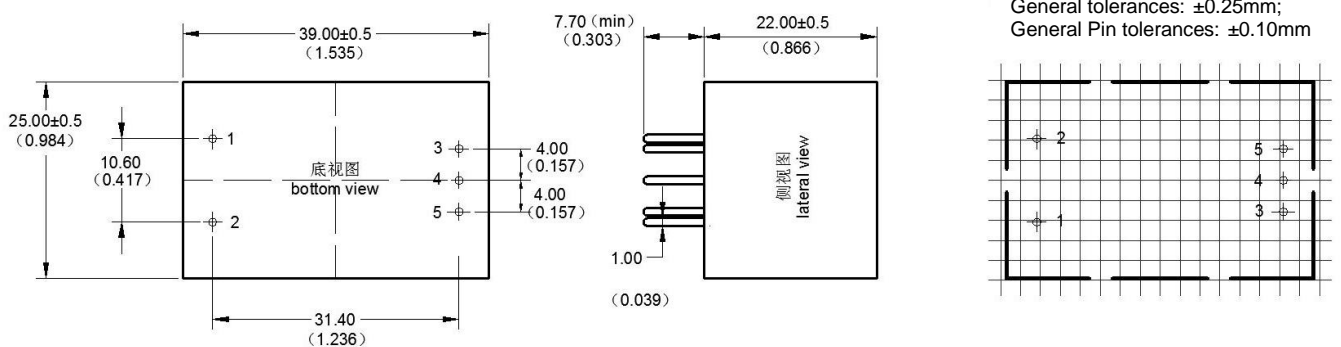

Packing Code	L x W x H	
D2	39.0X25.0 X22.0 mm	1.535 X0.984X0.866inch

### Pin Definition

Pin	1	2	3	4	5
Single(S)	AC(L)	AC(N)	+Vo	NP	-Vo

Note: If the definition of pin is not in accordance with the model selection manual, please refer to the label on actual item.

### Ripple & Noise Test: (Twisted Pair Method 20MHZ bandwidth)

Test Method:

(1) 12# twisted pair to connect, Oscilloscope bandwidth set as 20MHz, 100M bandwidth probe, terminated with 0.1uF polypropylene capacitor and 10uF high frequency low resistance electrolytic capacitor in parallel, oscilloscope set as Sample pattern.

(2) Input terminal connect to power supply, output terminal connect to electronic load through jig plate, Use 30cm±2 cm sampling line, Power line selected from corresponding diameter wire with insulation according to the flow of output current.

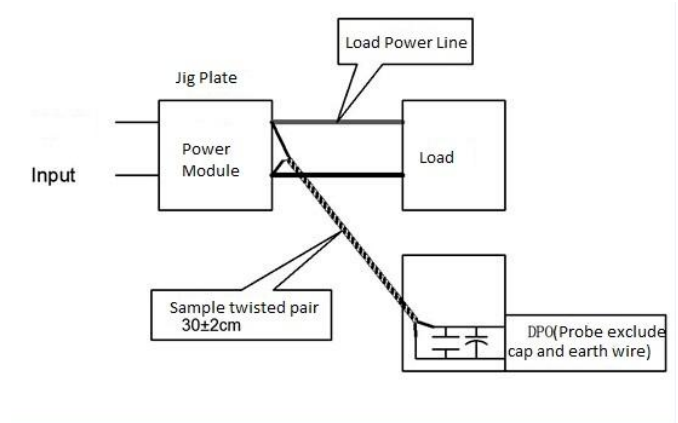

### Product Characteristic Curve

Input Voltage Derating Curve

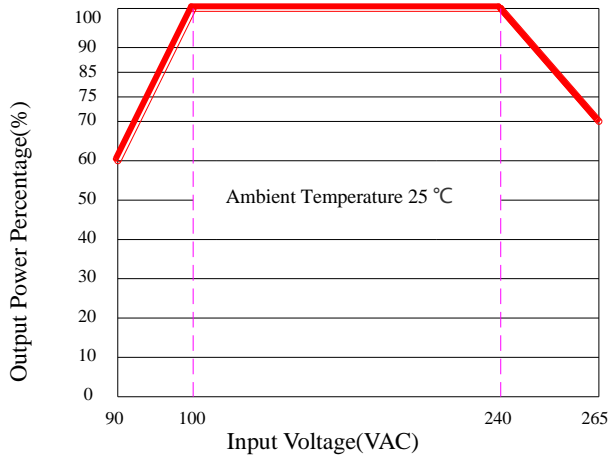

Temperature Derating Curve

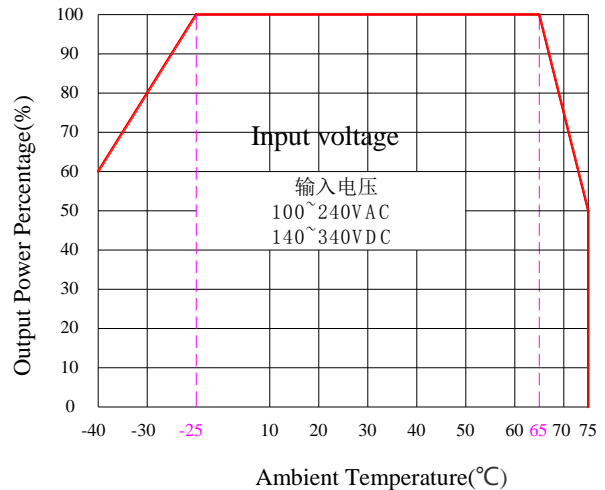

Note:

- 1: Input voltage should be derated based on input voltage derating curve when it is 85~100VAC/240~265VAC/120~140VDC/340~380VDC.
- 2: Our product is suitable to use under natural air cooling environment, if use it under closed condition, please contact with us.

### Typical EMC Application Circuit (recommended parameters)

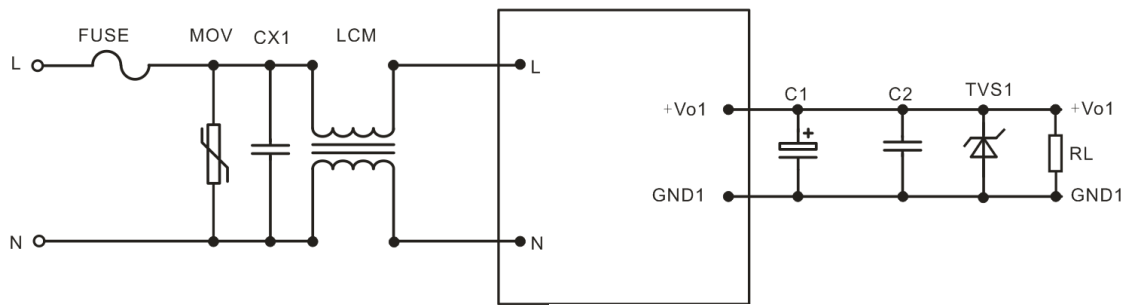

Photo 1

Note:

- 1) FUSE, suggest 2A~250Vac slow fusing, block form;
- 2) MOV is voltage dependent resistor, suggest model 14D561K;
- 3) CX1 is X capacitor, suggest model 0.1uF/275Vac;
- 4) LCM is common mode inductor, suggest value 30mH;
- 5) C1 choose high frequency low impedance electrolytic capacitor, the capacitance value less than capacitive load. Withstand voltage is 1.5 times more than output voltage;
- 6) C2 choose 0.1uF ceramic chip capacitor, withstand voltage is 1.5 times more than output voltage;
- 7) TVS1 is TVS tube; 5V output suggest to use: SMBJ7.0A, 9V output suggest to use: SMBJ12.0A, 12V output suggest to use: SMBJ20A, 15V output suggest to use: SMBJ20.0A, 24V output suggest to use: SMBJ30.0A, 48V output suggest to use: SMBJ64A.

Note

1. The product should be used under the specification range, otherwise it will cause permanent damage to it.
2. Product's input terminal should connect to fuse;
3. If the product worked beyond the load range, we cannot ensure that the performance of product is in accordance with all the indexes in this manual;
4. Unless otherwise specified, data in this datasheet should be tested under conditions of  $T_a=25^{\circ}\text{C}$ , humidity<75% when inputting nominal voltage and outputting rated load(pure resistance load);
5. All index testing methods in this datasheet are based on our Company's corporate standards
6. The performance indexes of the product models listed in this manual are as above, but some indexes of non-standard model products will exceed the above-mentioned requirements, and please directly contact our technician for specific information;
7. We can provide customized product service;
8. The product specification may be changed at any time without prior notice.