

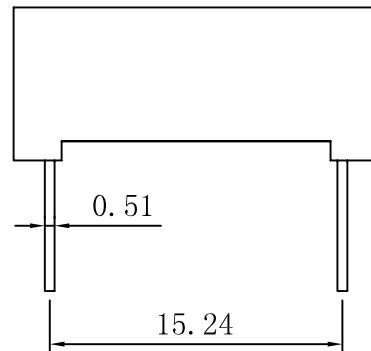

科宏光电(深圳)有限公司
KEHONG OPTO ELECTRONICS (SHENZHEN) CO., LTD.

PACKAGE DIMENSION

KHN10502

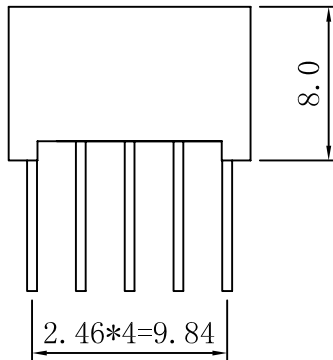
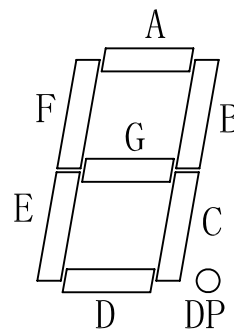
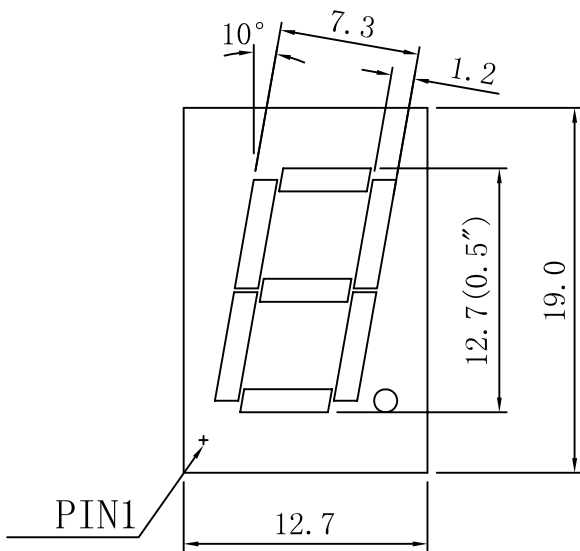

CODE A

3,8

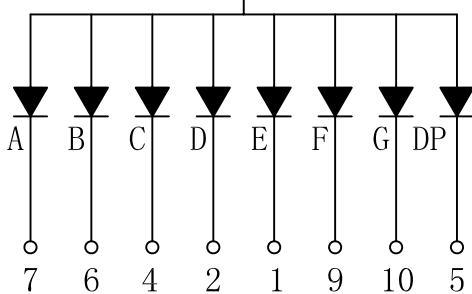

CODE C

3,8

