

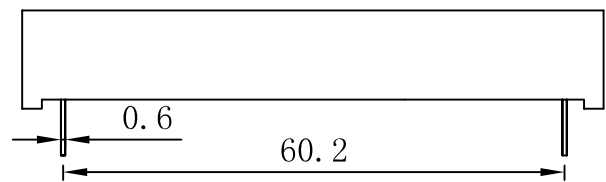

科宏光电(深圳)有限公司  
KEHONG OPTO ELECTRONICS (SHENZHEN) CO., LTD.

# PACKAGE DIMENSION

KHN12303

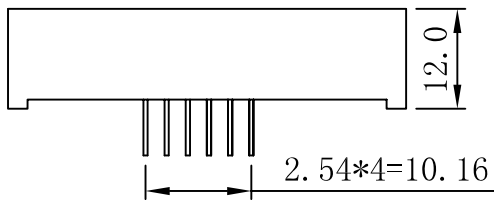
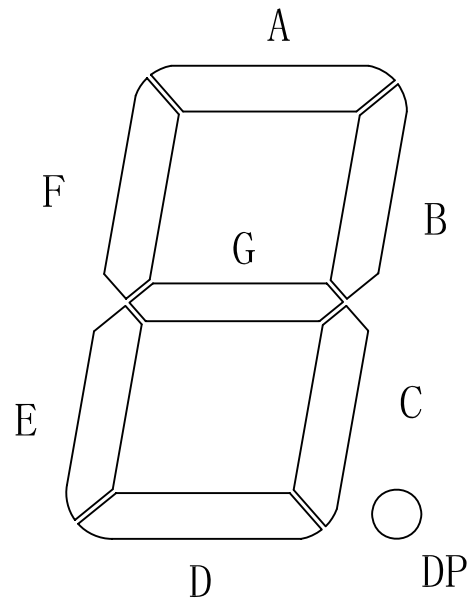
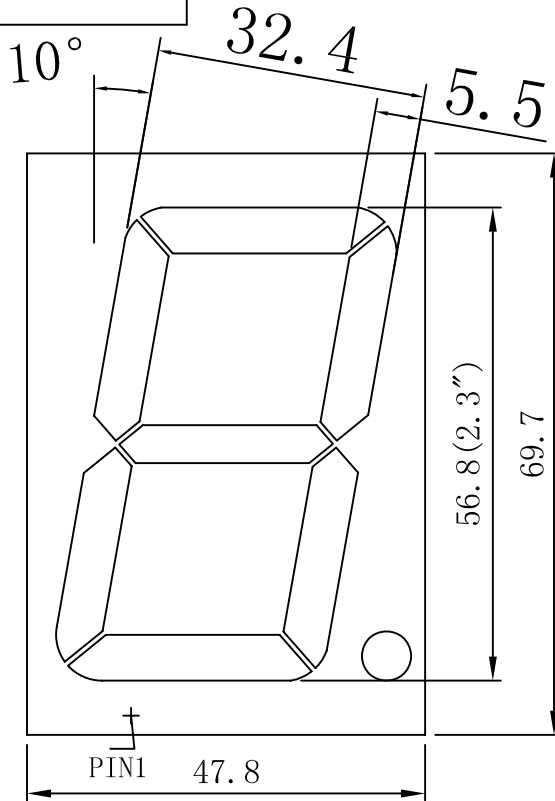

CODE A

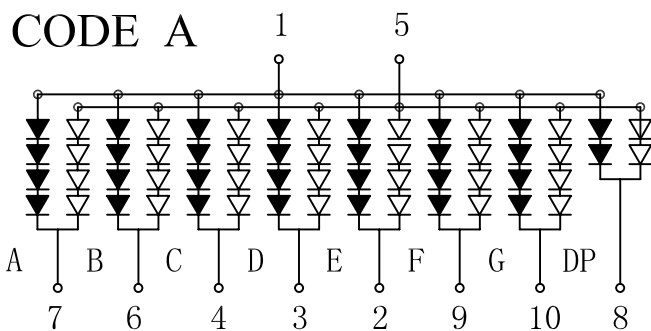

CODE C

