

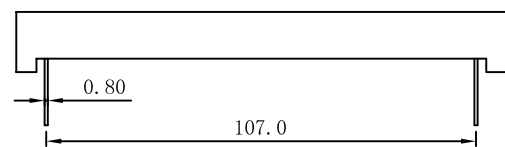

科宏光电(深圳)有限公司
KEHONG OPTO ELECTRONICS (SHENZHEN) CO., LTD.

PACKAGE DIMENSION

KHN14002

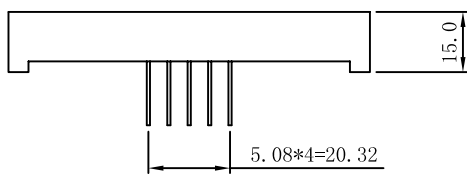
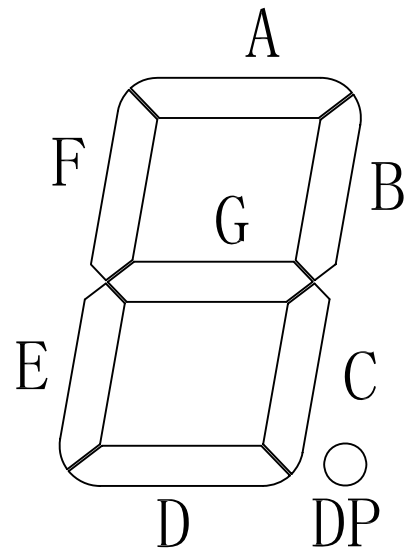
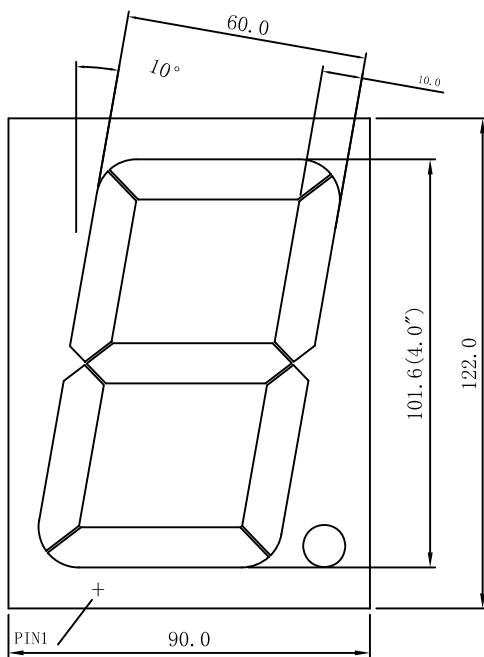

CODE A

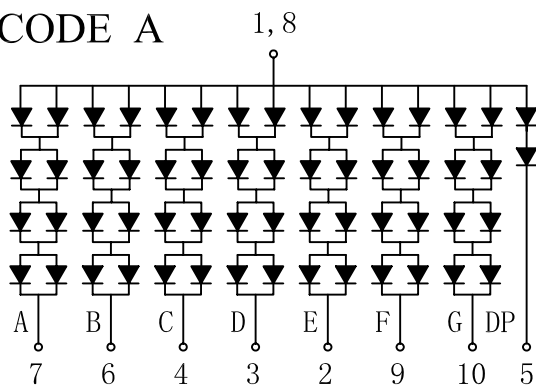

CODE C

