

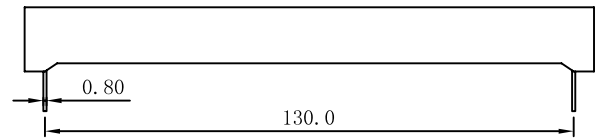

科宏光电(深圳)有限公司  
KEHONG OPTO ELECTRONICS (SHENZHEN) CO., LTD.

# PACKAGE DIMENSION

KHN15001

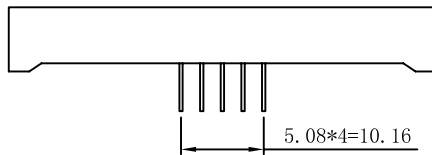
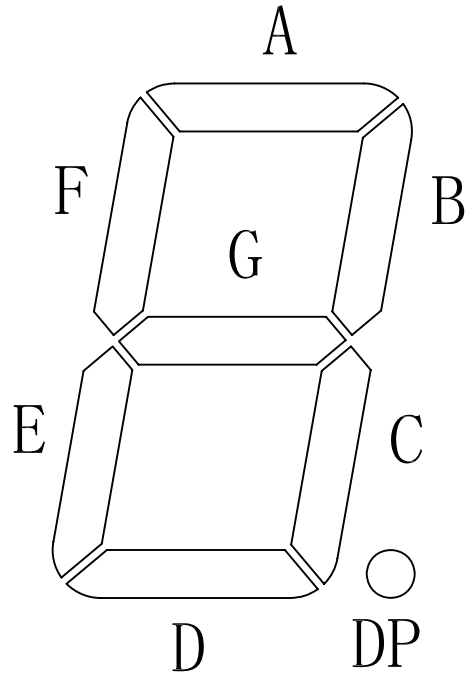
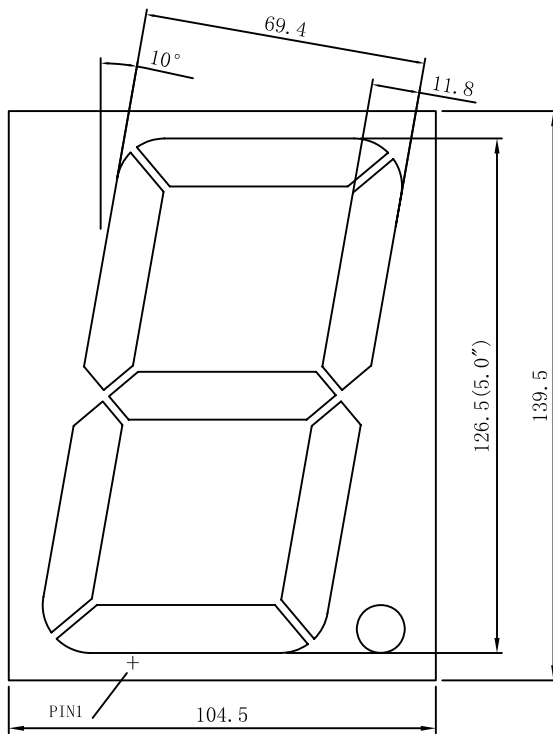

CODE A

1, 8

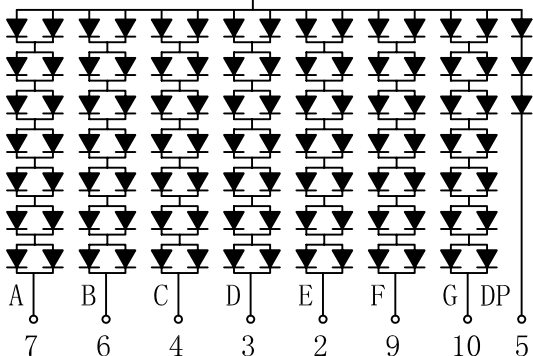

CODE C

1, 8

