

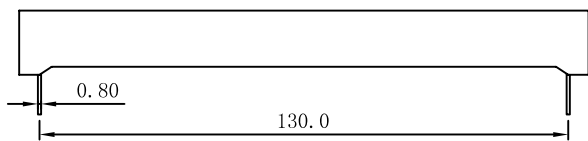

科宏光电(深圳)有限公司  
KEHONG OPTO ELECTRONICS (SHENZHEN) CO., LTD.

# PACKAGE DIMENSION

KHN15002

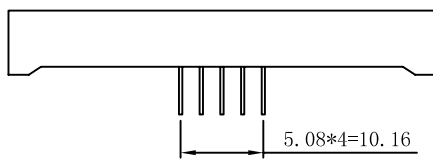
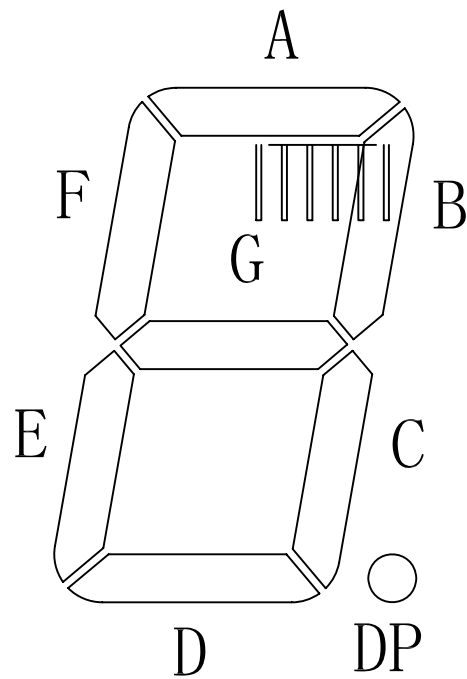
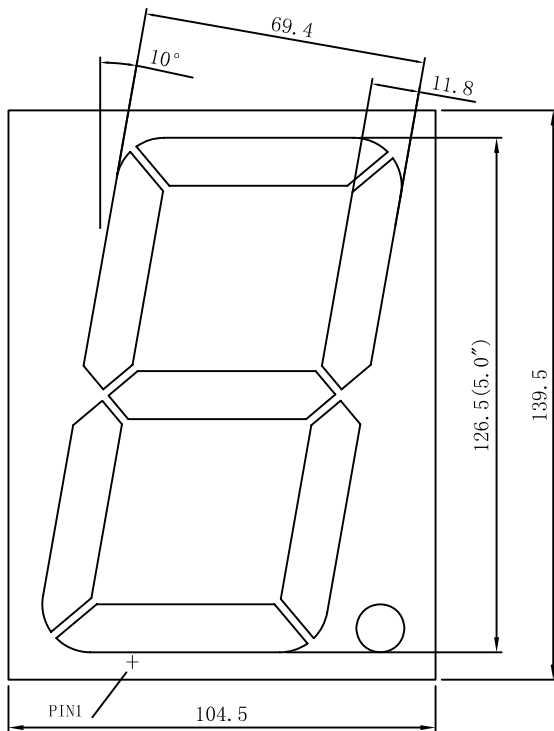

CODE A

1,8

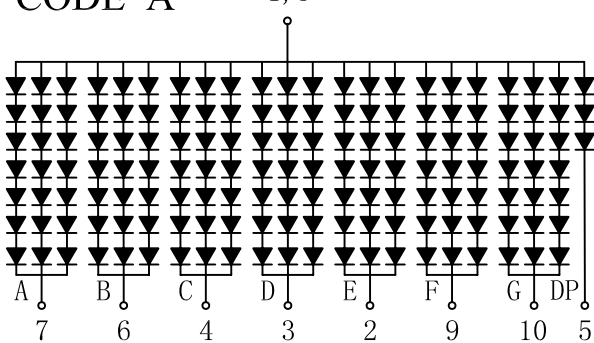

CODE C

1,8

