

特性曲线

Characteristic Curves

磁导率与直流磁化场曲线 Permeability vs Magnetizing Force Curves

NS

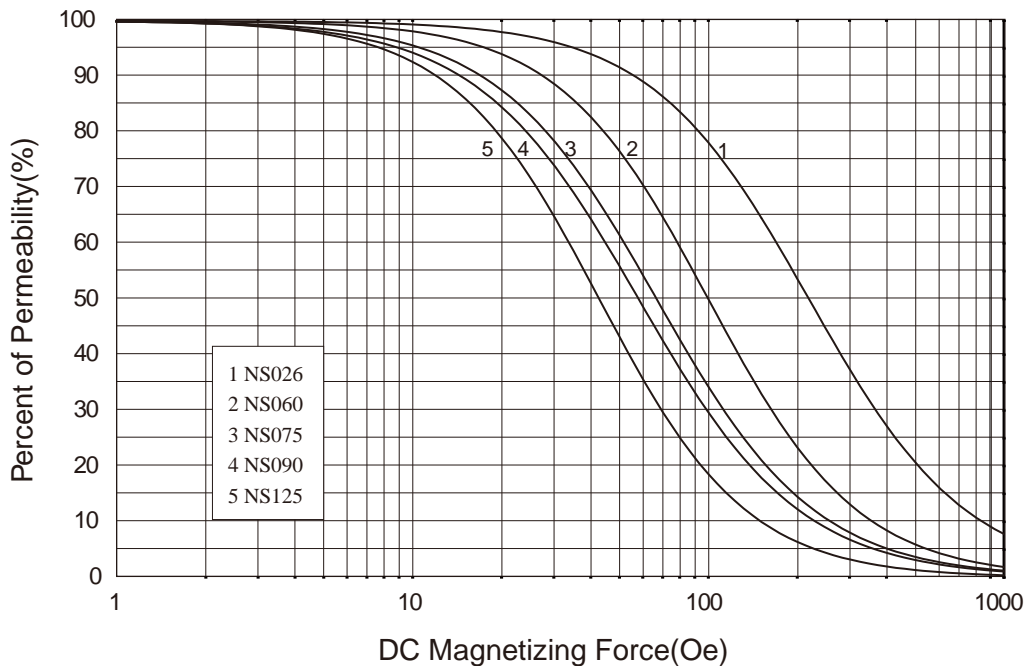

NH

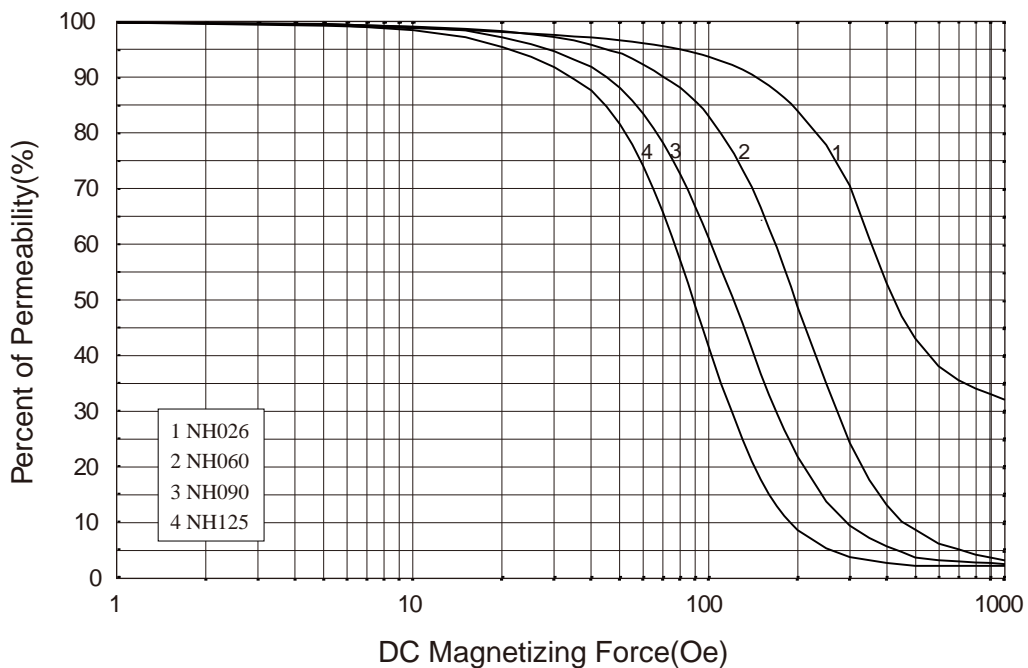

特性曲线 Characteristic Curves

磁导率与直流磁化场曲线 Permeability vs Magnetizing Force Curves

NK

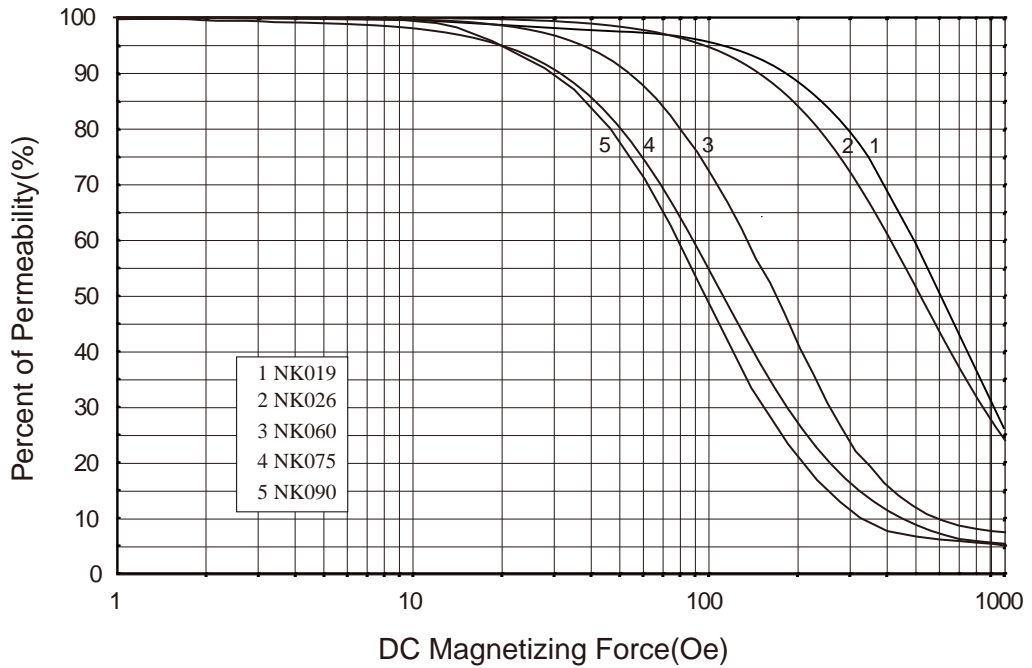

NKS

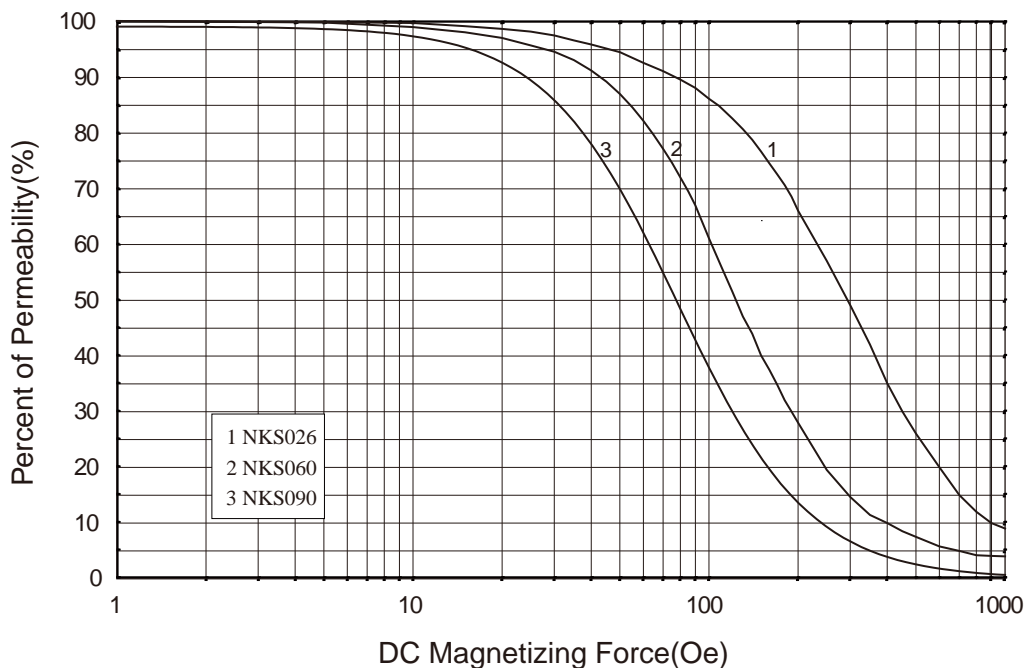

特性曲线

Characteristic Curves

磁导率与直流磁化场曲线 Permeability vs Magnetizing Force Curves

NSW

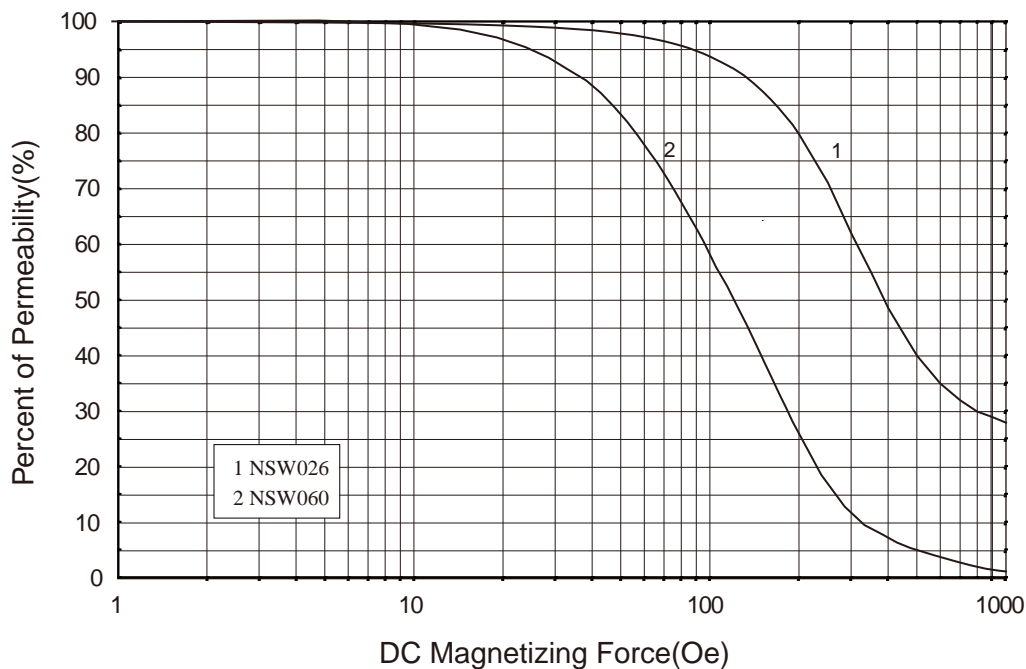

NSWL

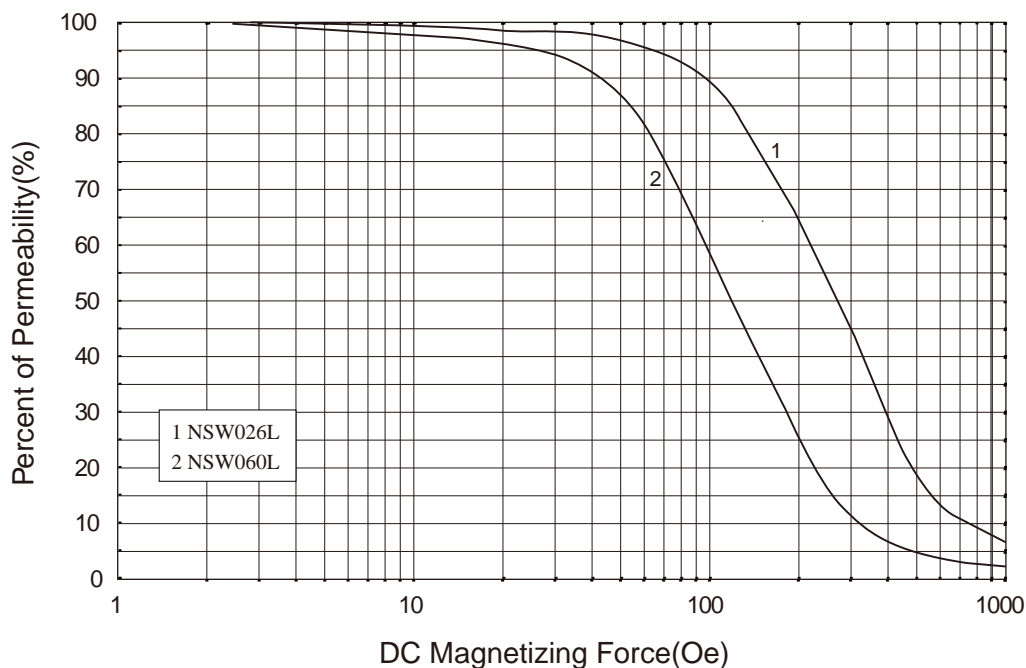

特性曲线 Characteristic Curves

磁导率与直流磁化场曲线 Permeability vs Magnetizing Force Curves

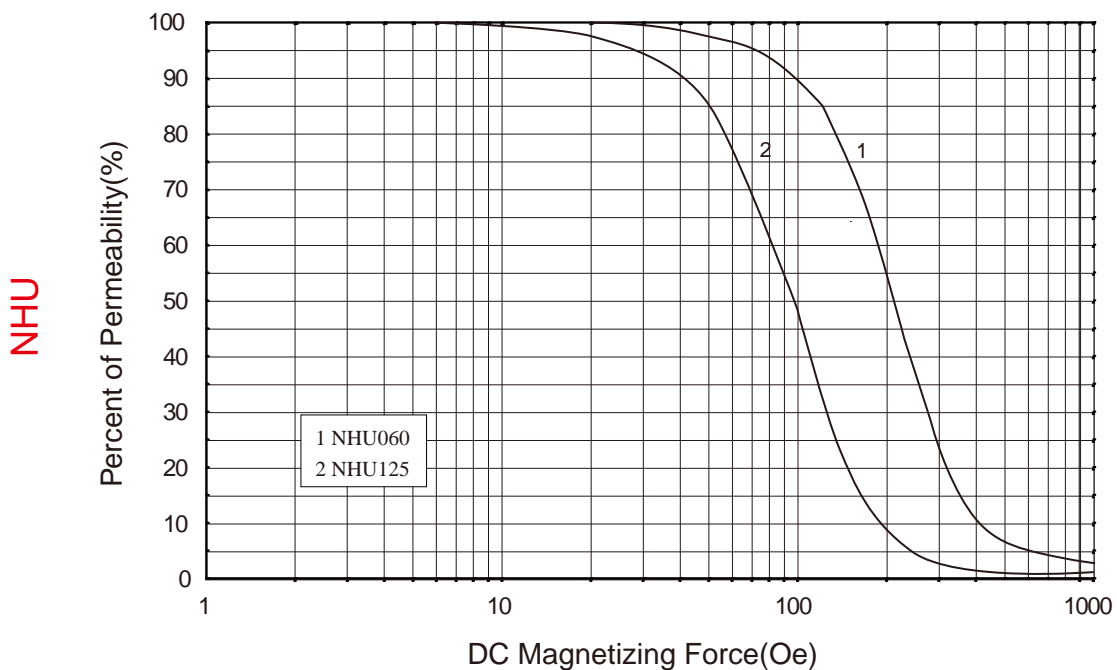
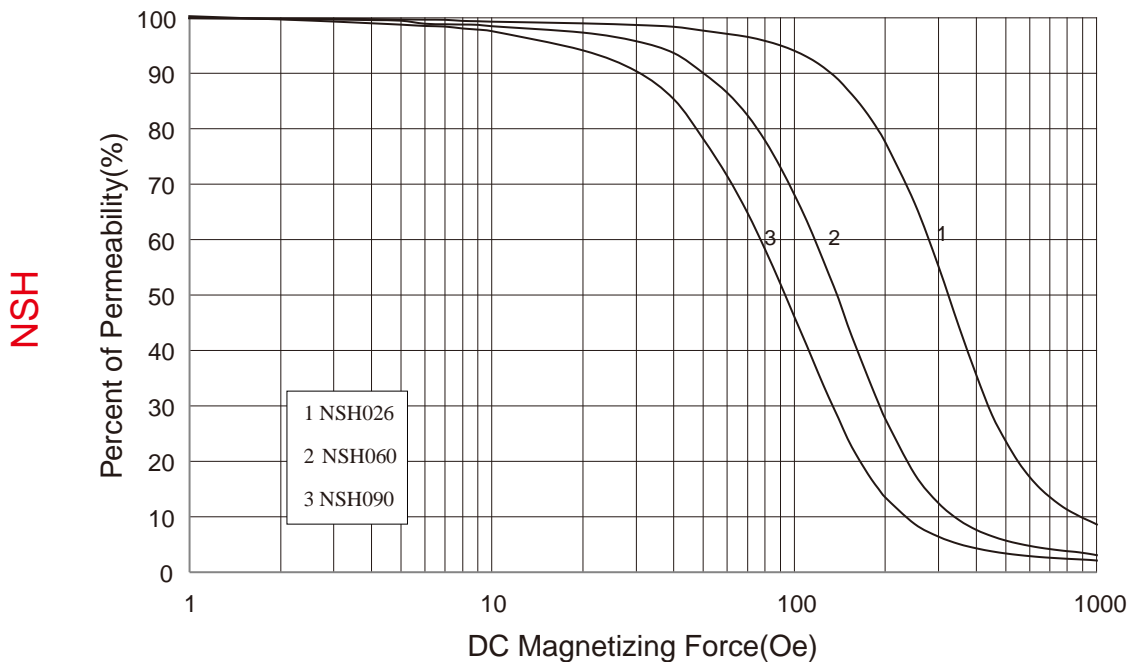

特性曲线

Characteristic Curves

磁导率与直流磁化场曲线 Permeability vs Magnetizing Force Curves

NHS

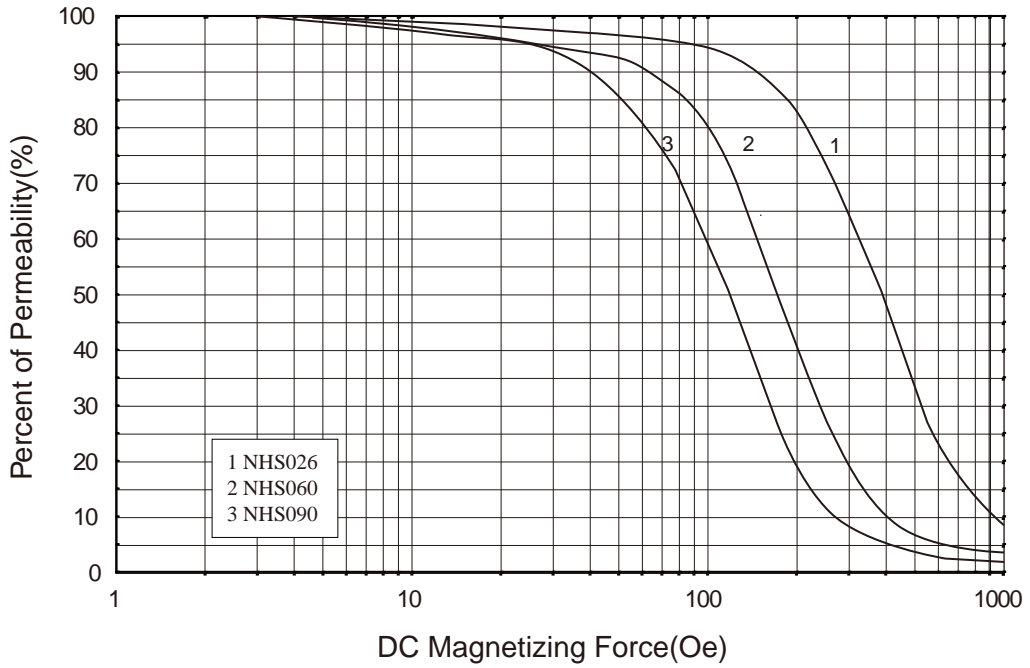

NKH

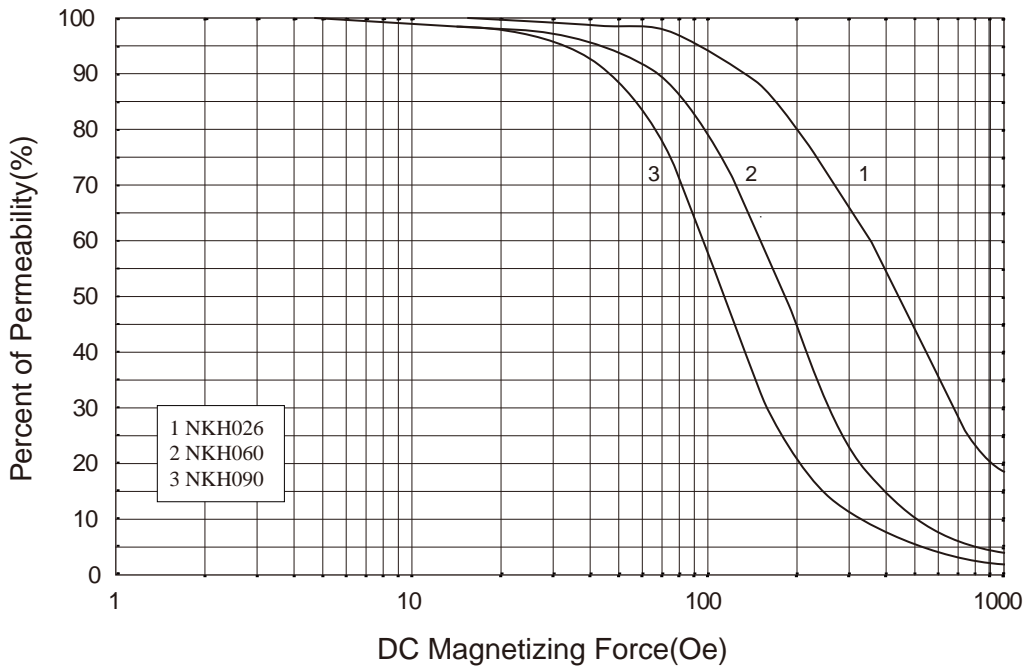

特性曲线 Characteristic Curves

磁导率与直流磁化场曲线 Permeability vs Magnetizing Force Curves

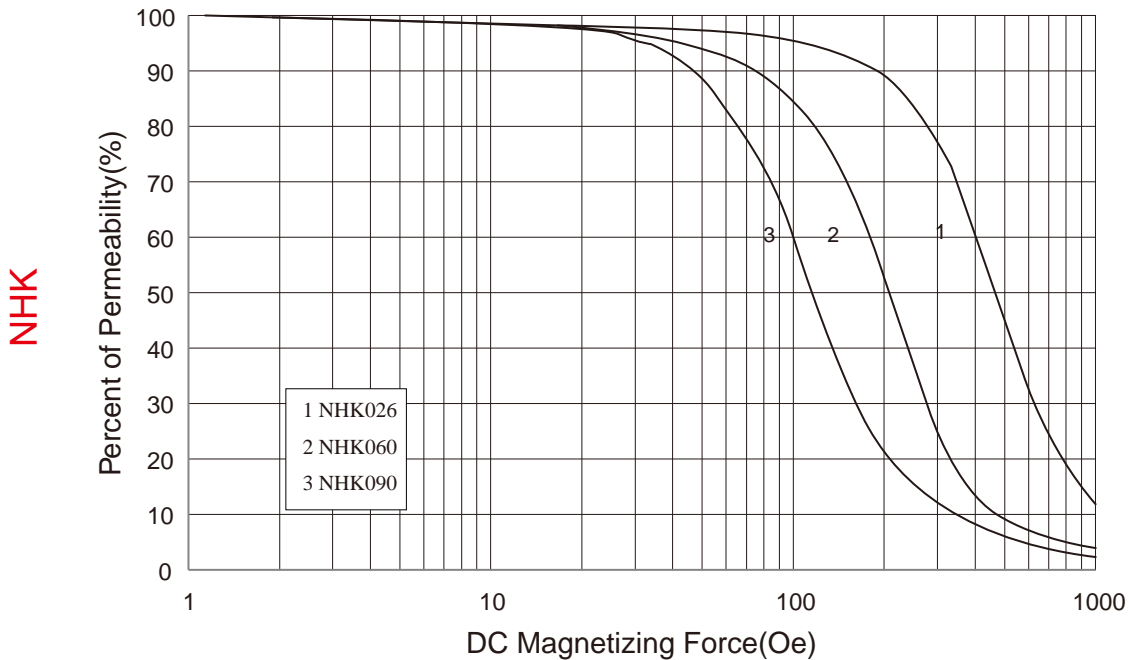

特性曲线 Characteristic Curves

功耗曲线 Curves of Power Loss

NS 26 μ , 40 μ

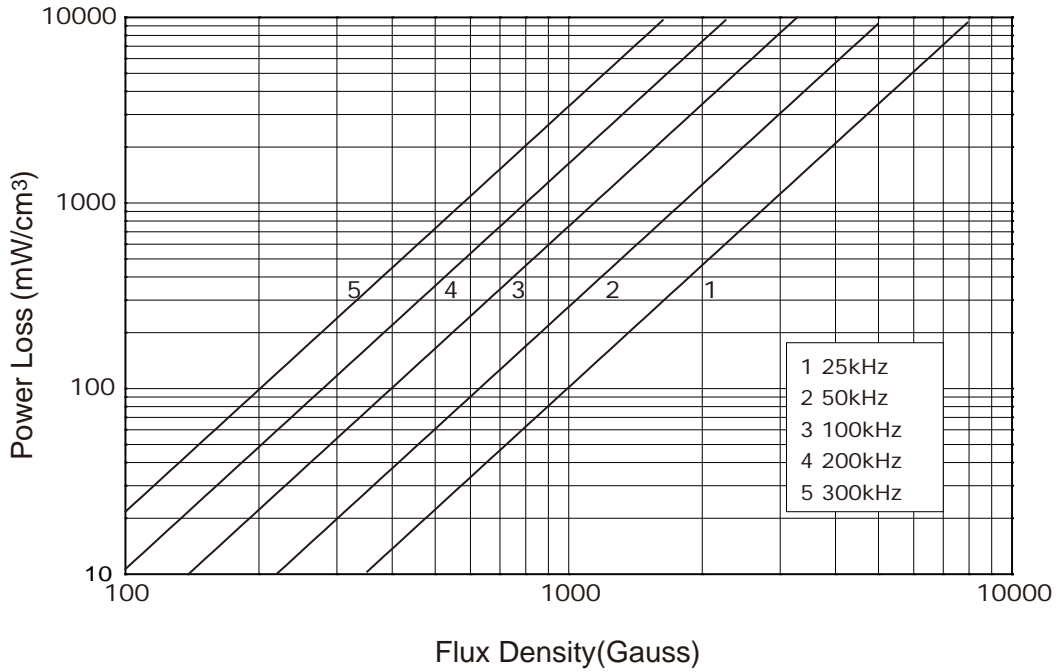

NS 60 μ , 75 μ , 90 μ , 125 μ

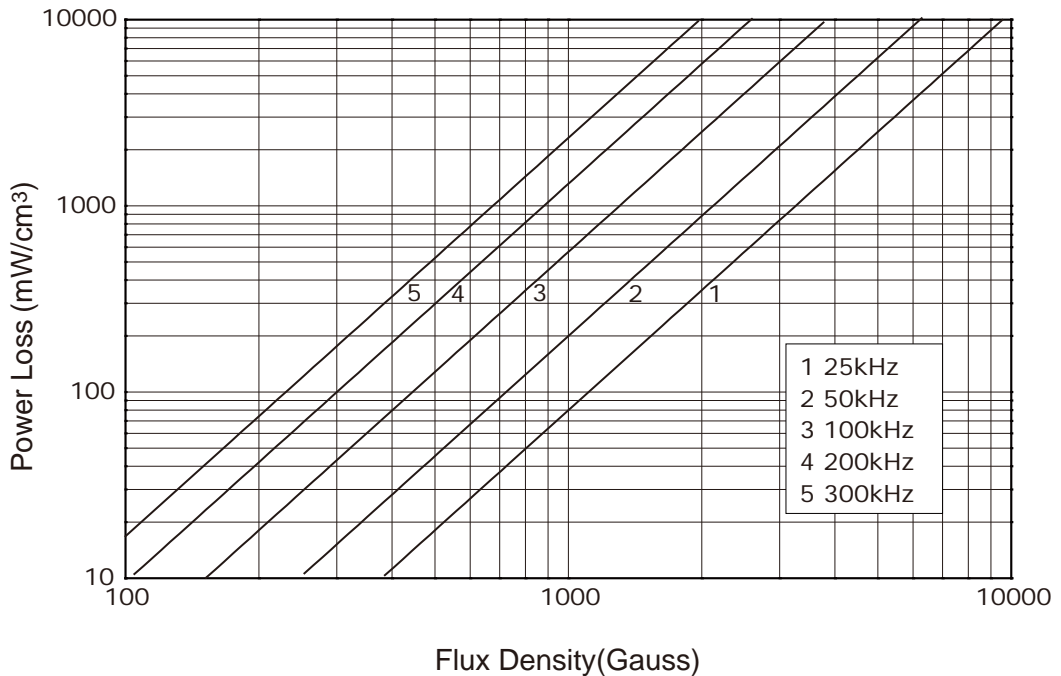

特性曲线 Characteristic Curves

功耗曲线 Curves of Power Loss

NH 026 μ , 040 μ

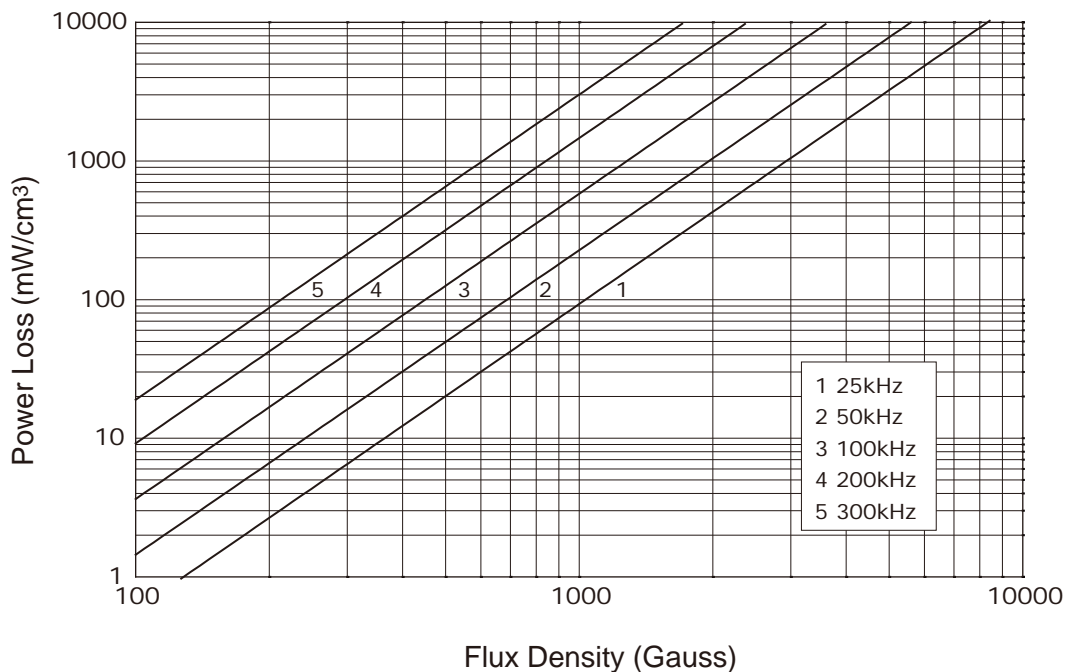

NH 060 μ

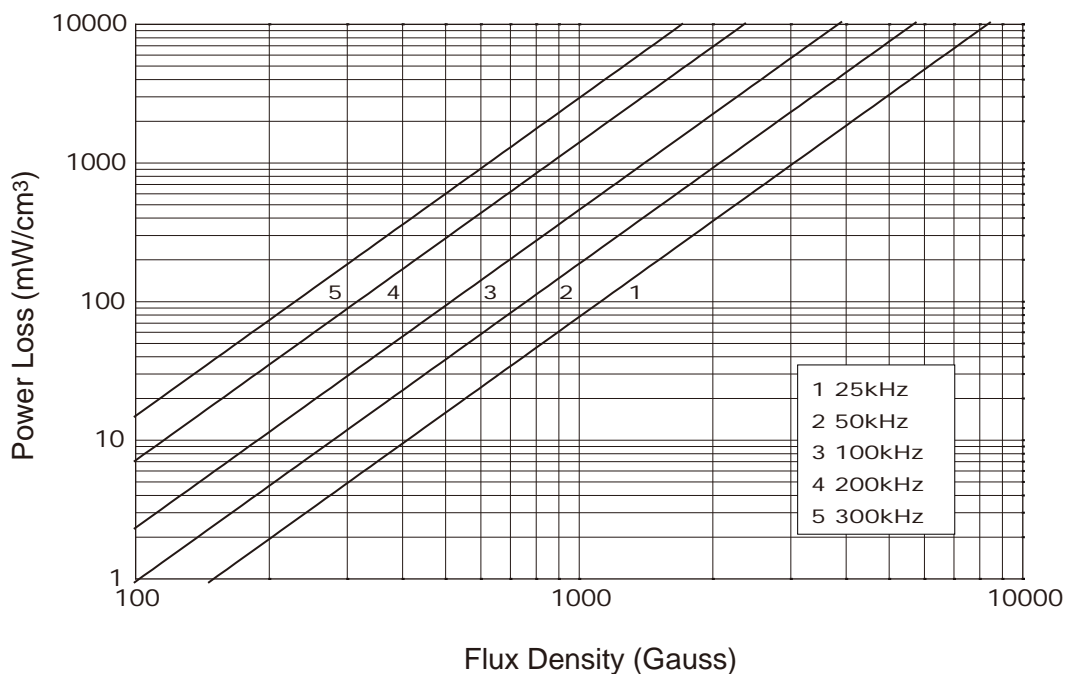

特性曲线 Characteristic Curves

功耗曲线 Curves of Power Loss

NH 090μ, 125μ

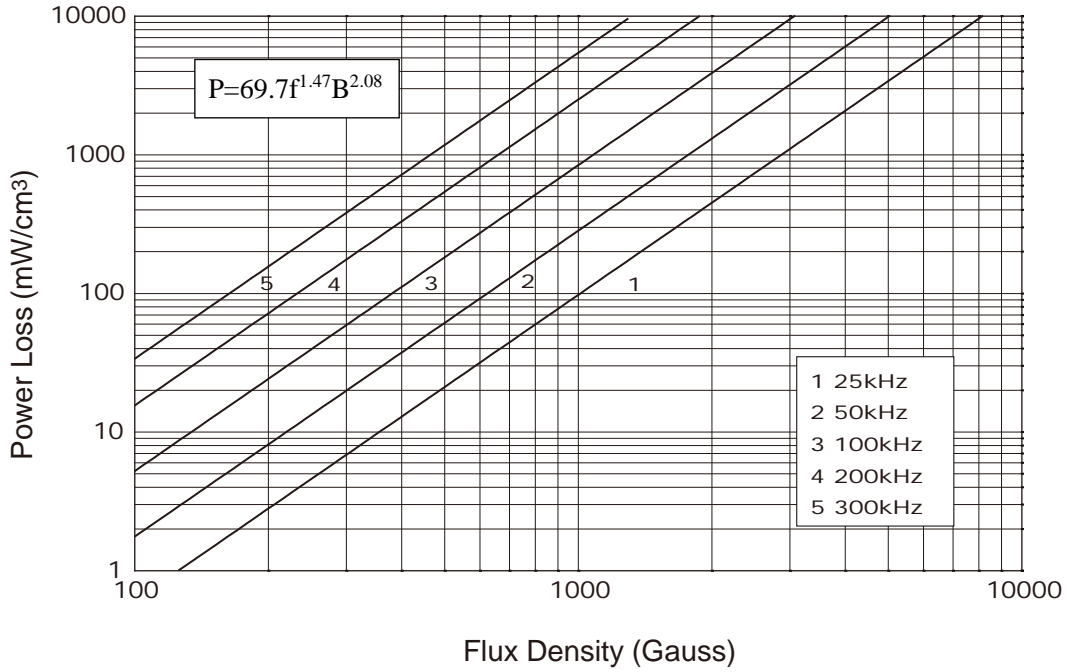

NK019

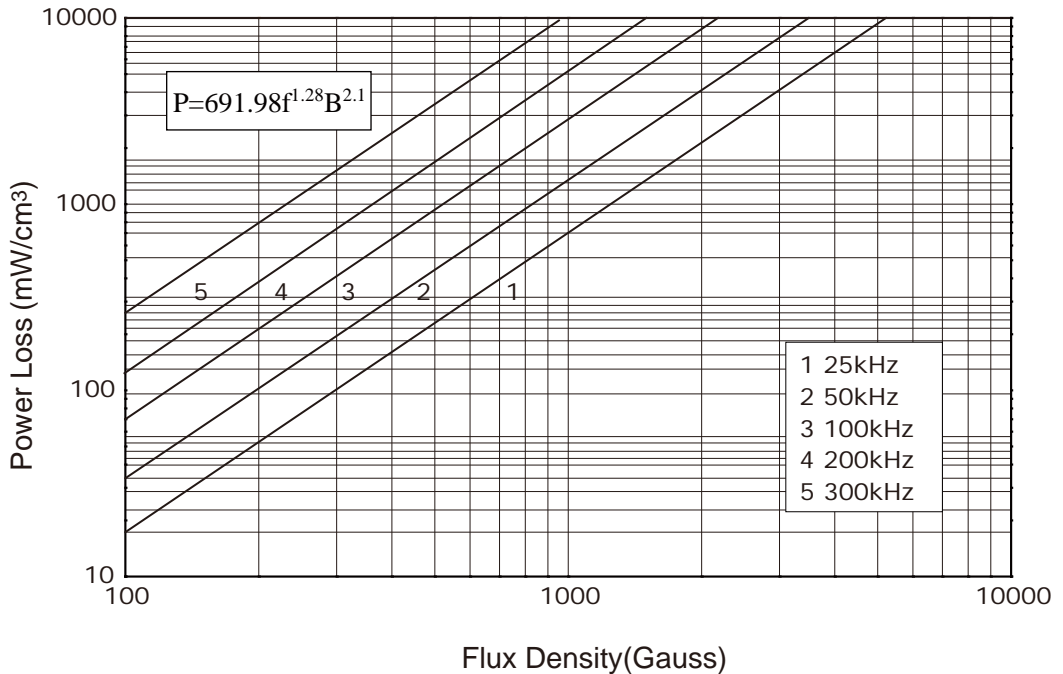

特性曲线 Characteristic Curves

功耗曲线 Curves of Power Loss

NK 026μ, 040μ

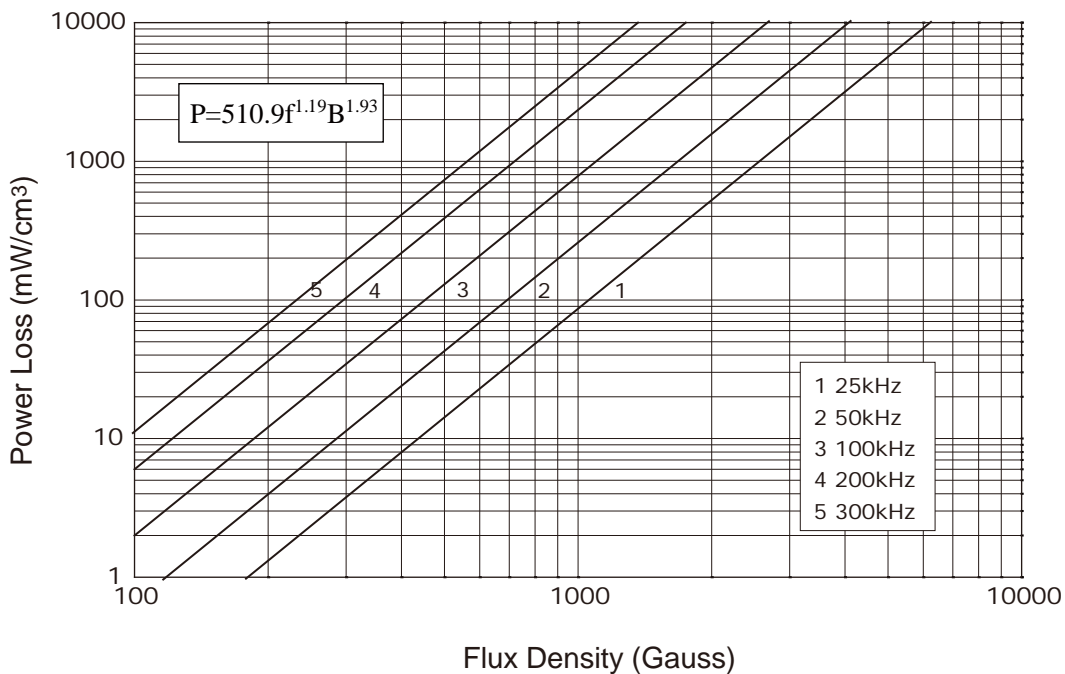

NK 060μ, 075μ, 090μ

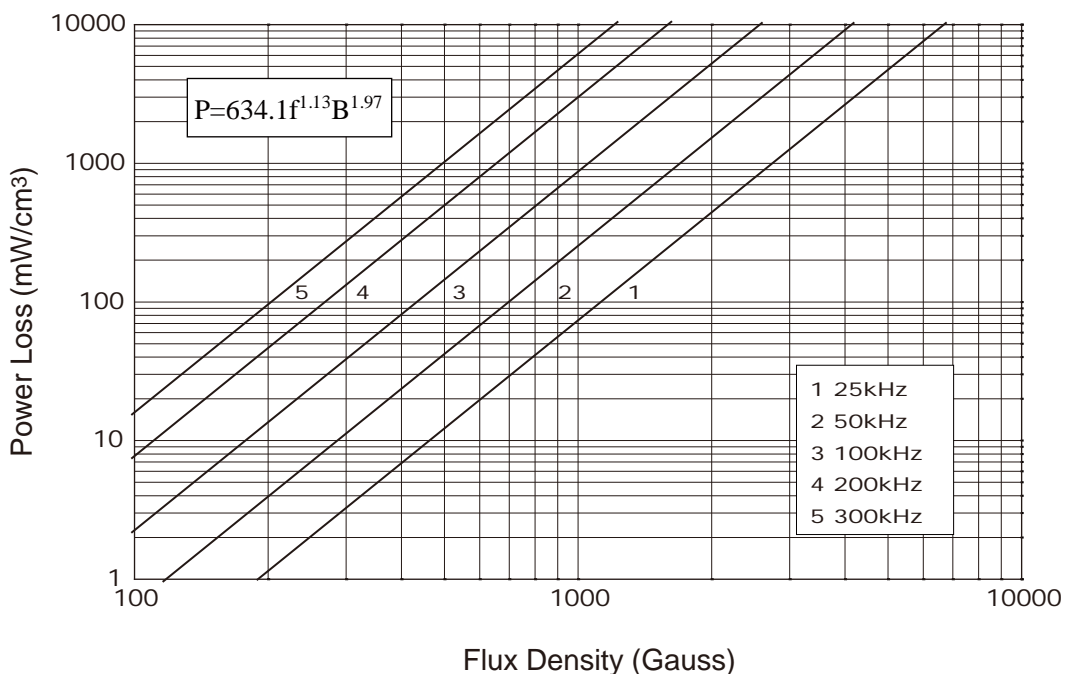

特性曲线

Characteristic Curves

功耗曲线 Curves of Power Loss

NKS 026μ, 040μ

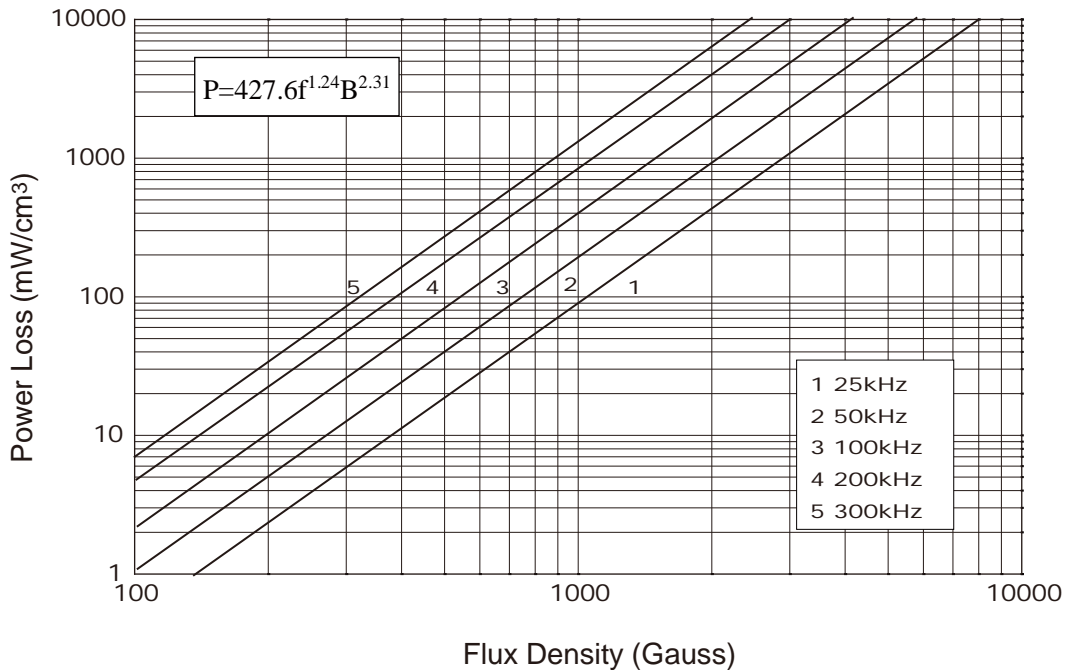

NKS 060μ

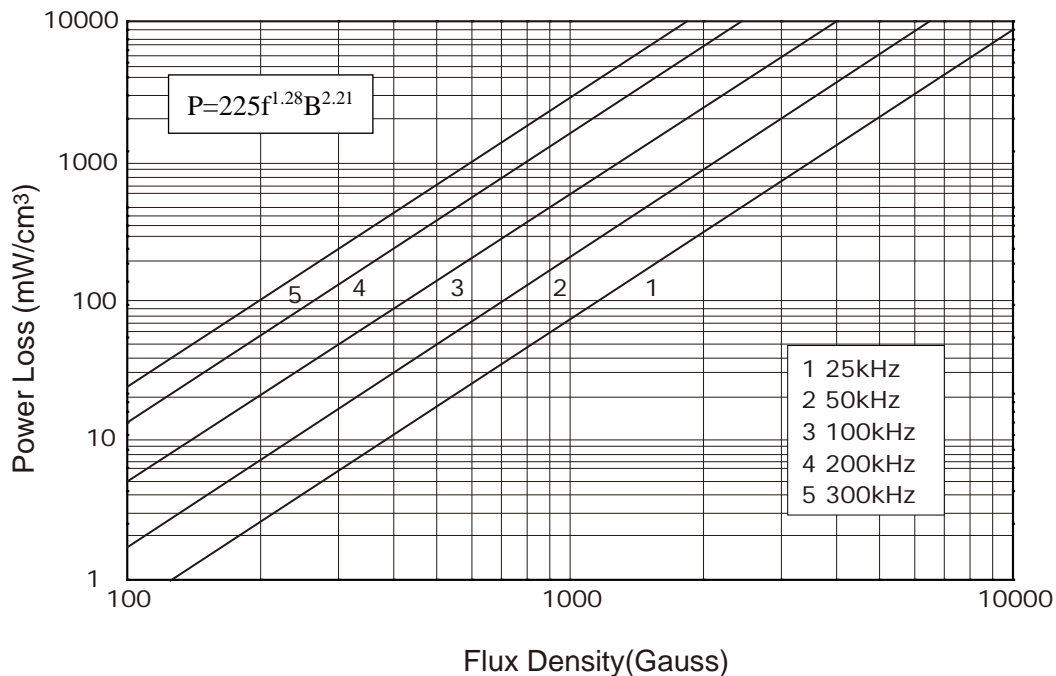

特性曲线 Characteristic Curves

功耗曲线 Curves of Power Loss

NKS 090μ

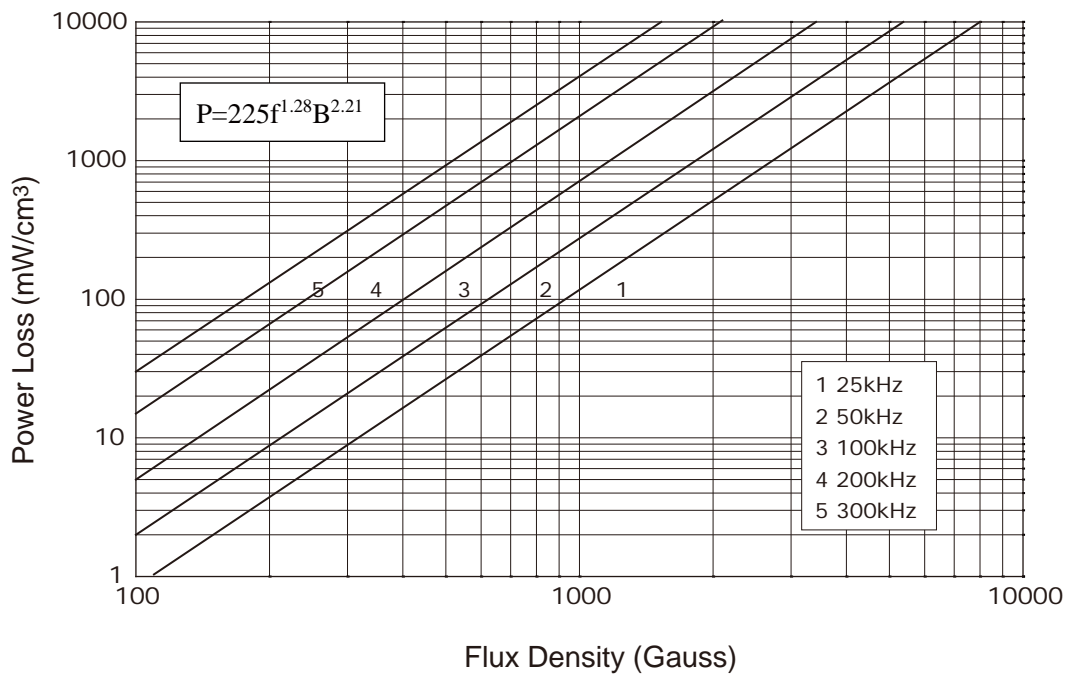

NSW 026μ, 040μ

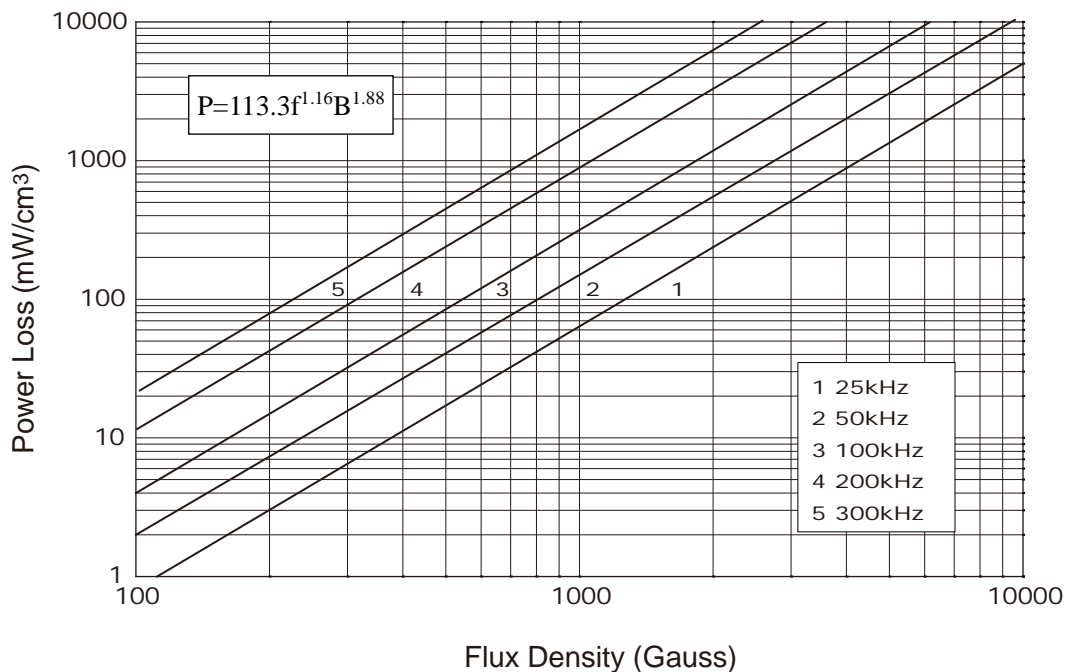

特性曲线

Characteristic Curves

功耗曲线 Curves of Power Loss

NSW 060μ

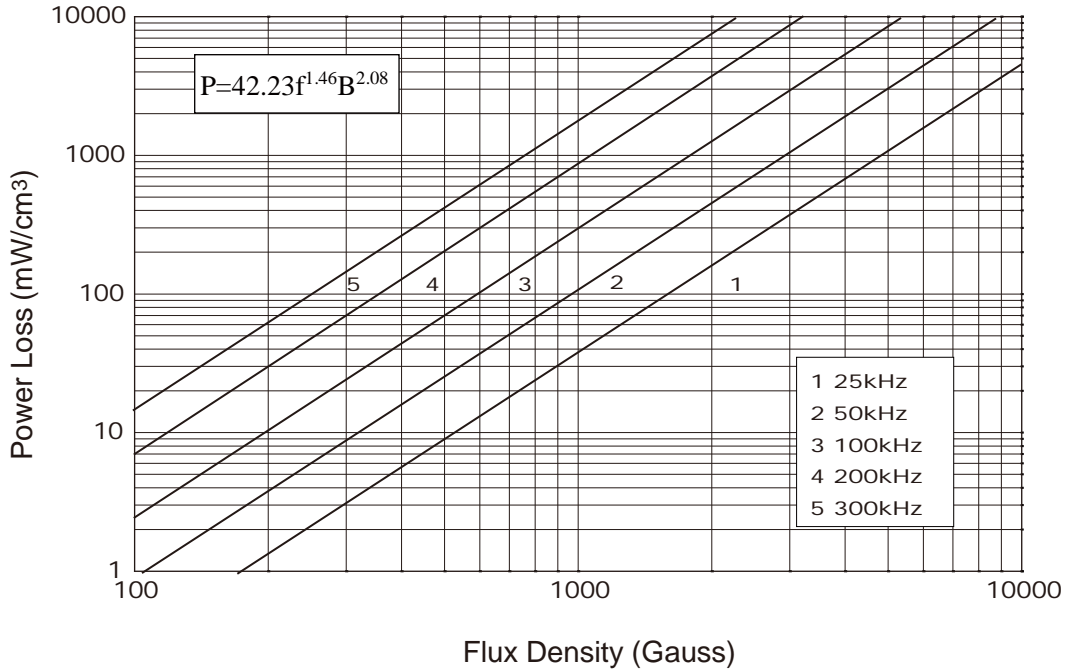

NSWL 026μ,040μ

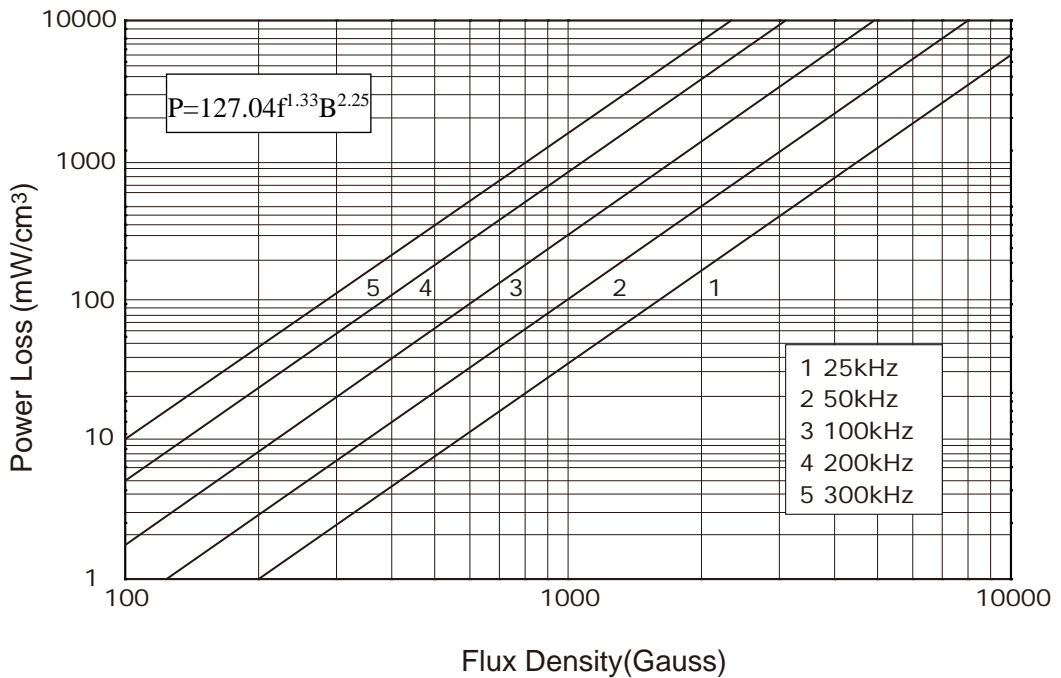

特性曲线 Characteristic Curves

功耗曲线 Curves of Power Loss

NSWL 060μ

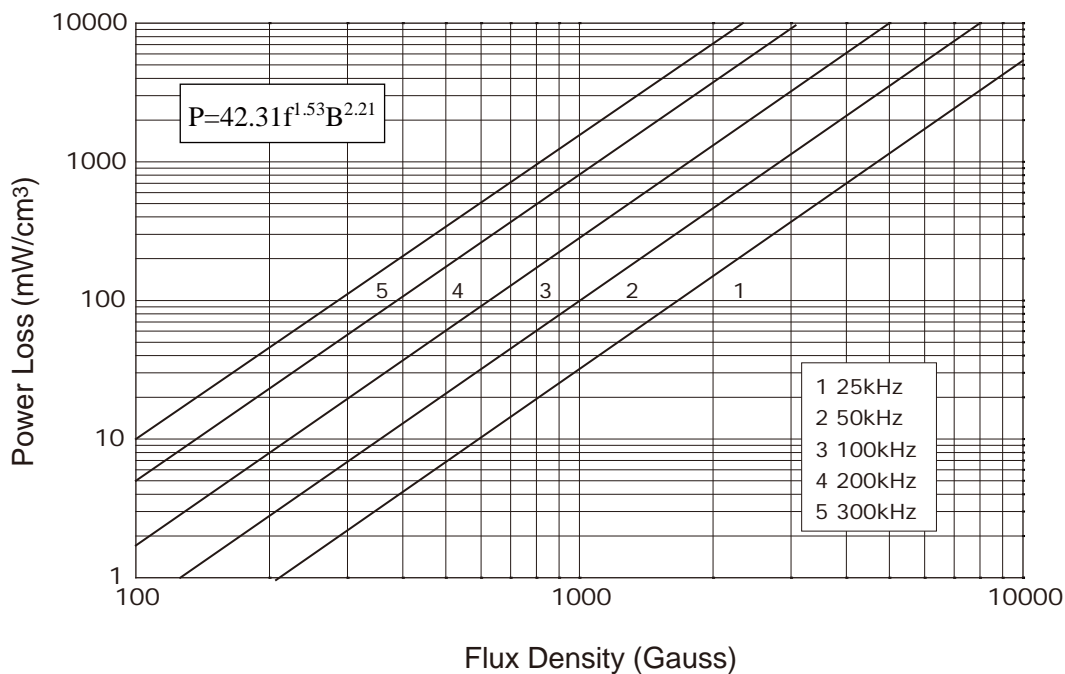

NSH 026μ, 040μ

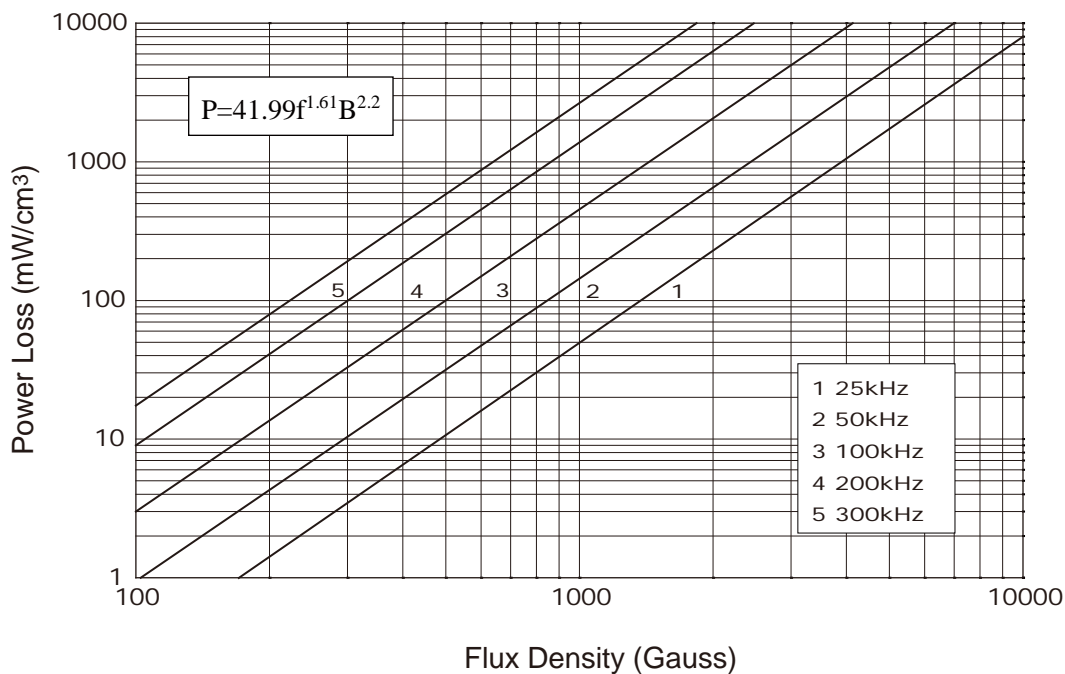

特性曲线

Characteristic Curves

功耗曲线 Curves of Power Loss

NSH 060μ, 090μ

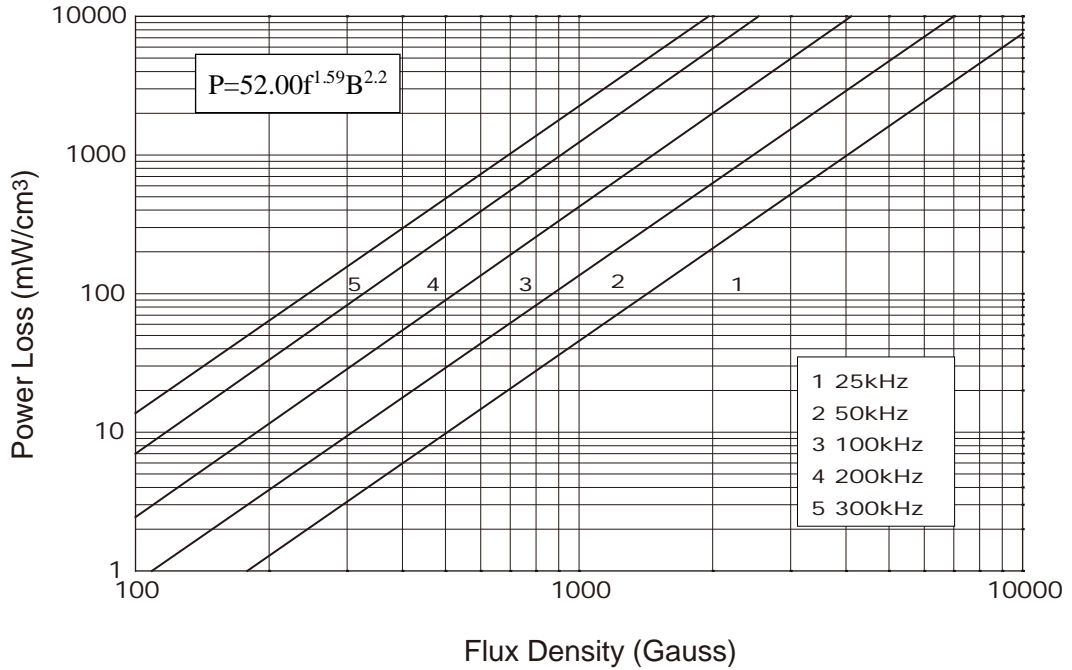

NHU 060μ

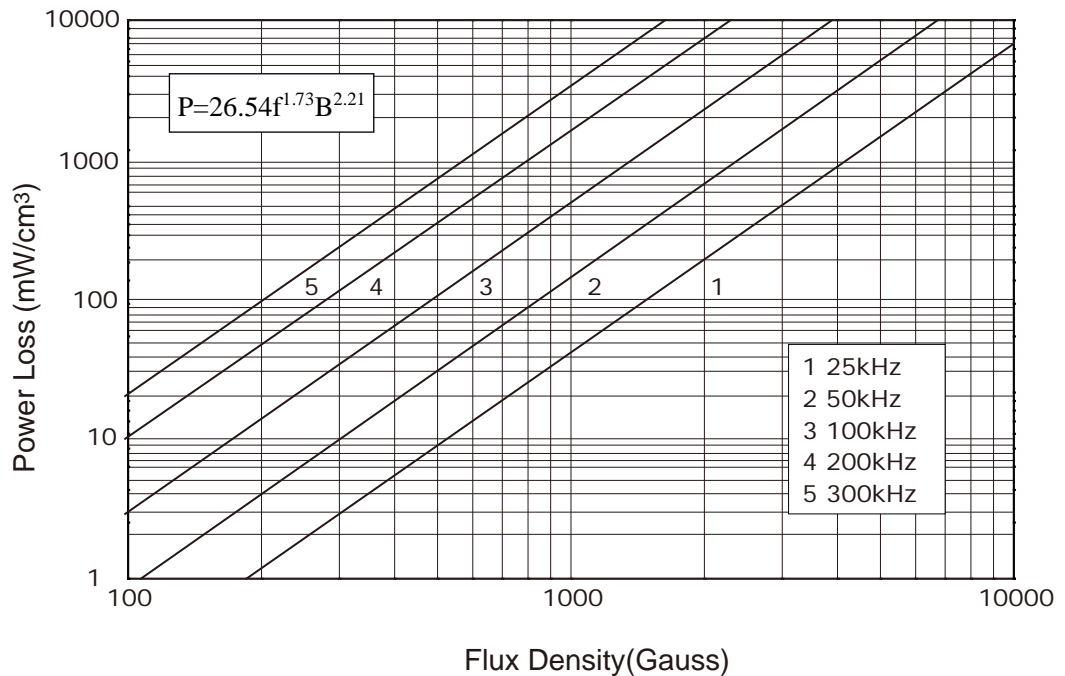

特性曲线 Characteristic Curves

功耗曲线 Curves of Power Loss

NHU 125μ

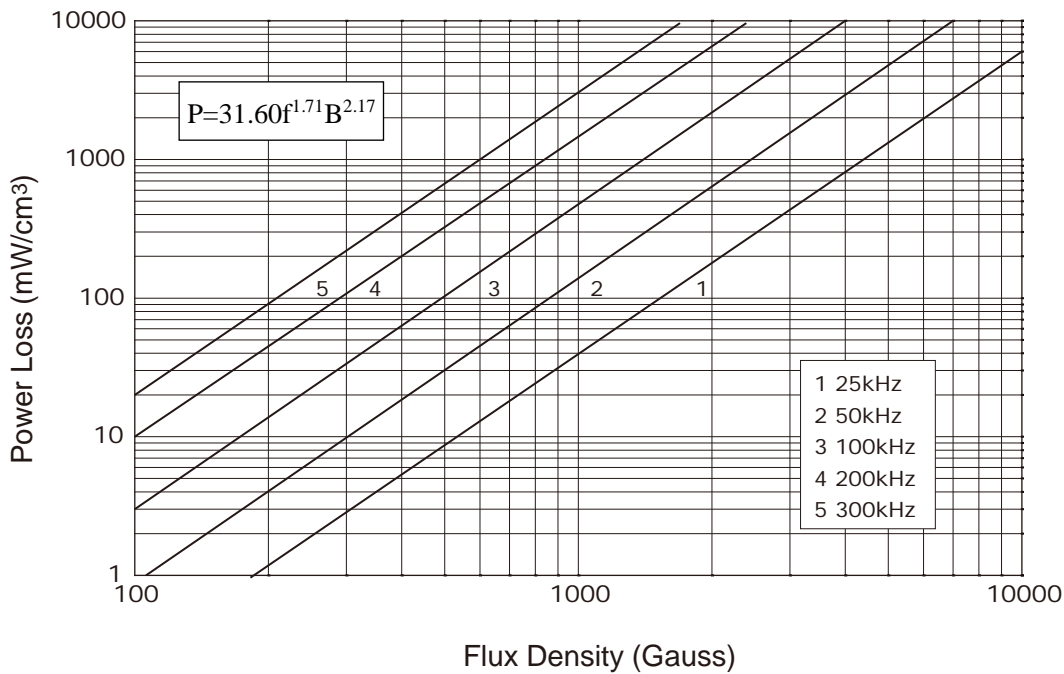

NHS 026μ,040μ

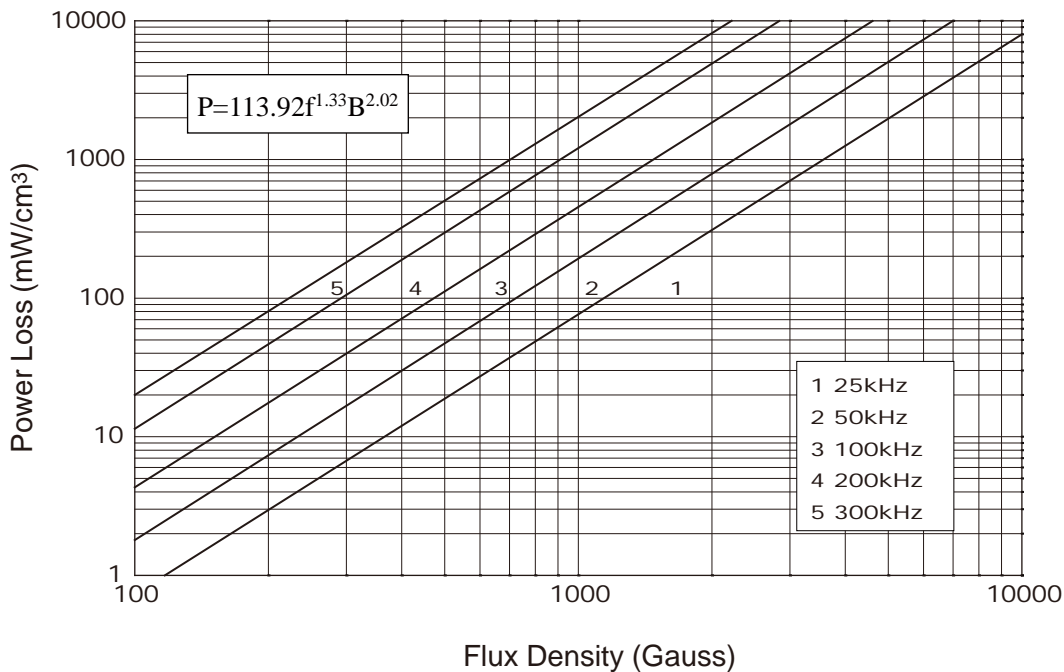

特性曲线

Characteristic Curves

功耗曲线 Curves of Power Loss

NHS 060μ, 090μ

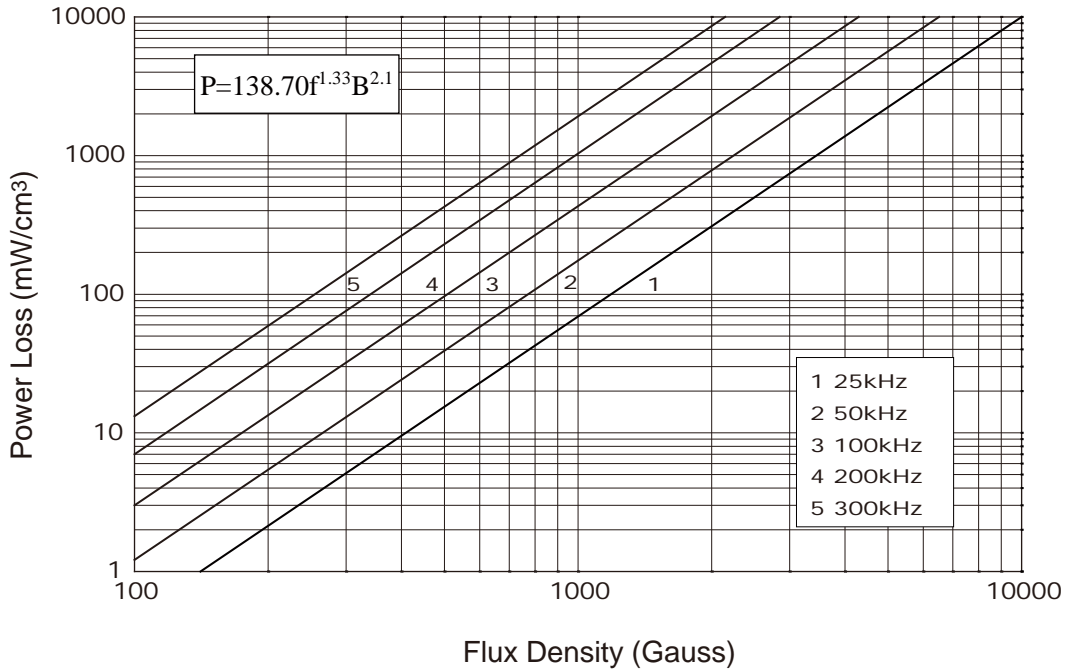

NKH 026μ, 040μ

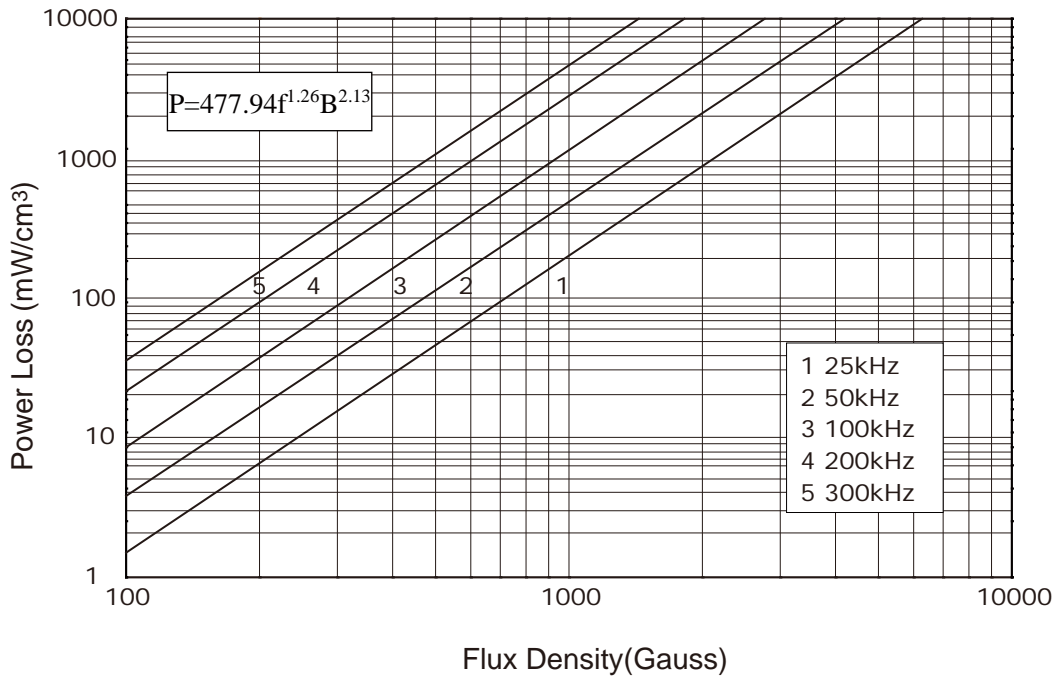

特性曲线 Characteristic Curves

功耗曲线 Curves of Power Loss

NKH 060μ, 090μ

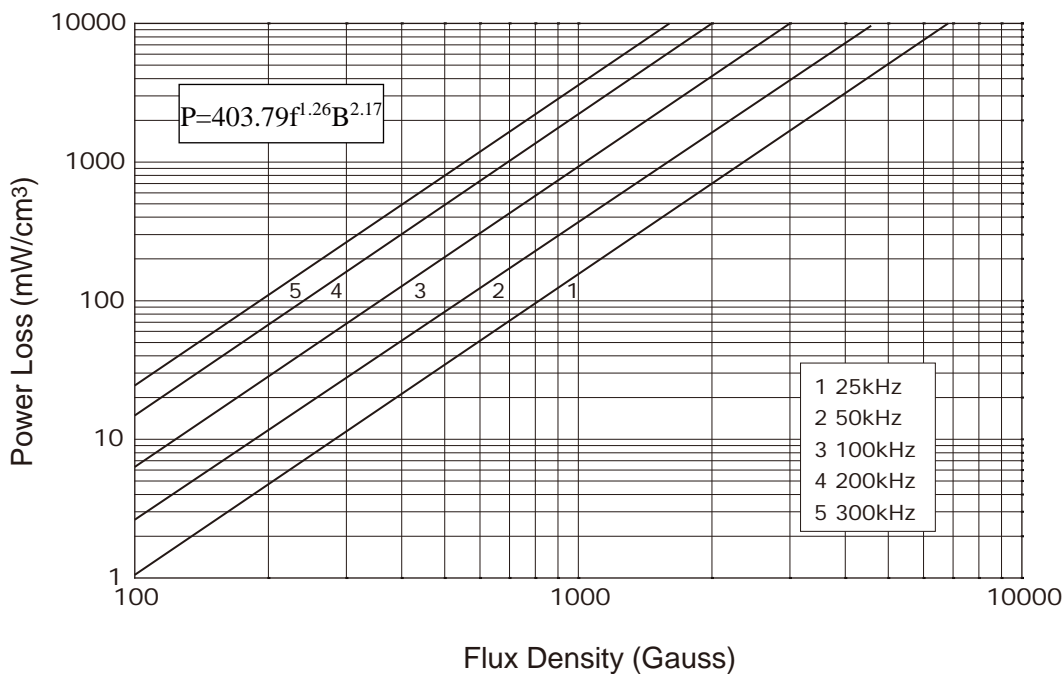

NHK 026μ, 040μ

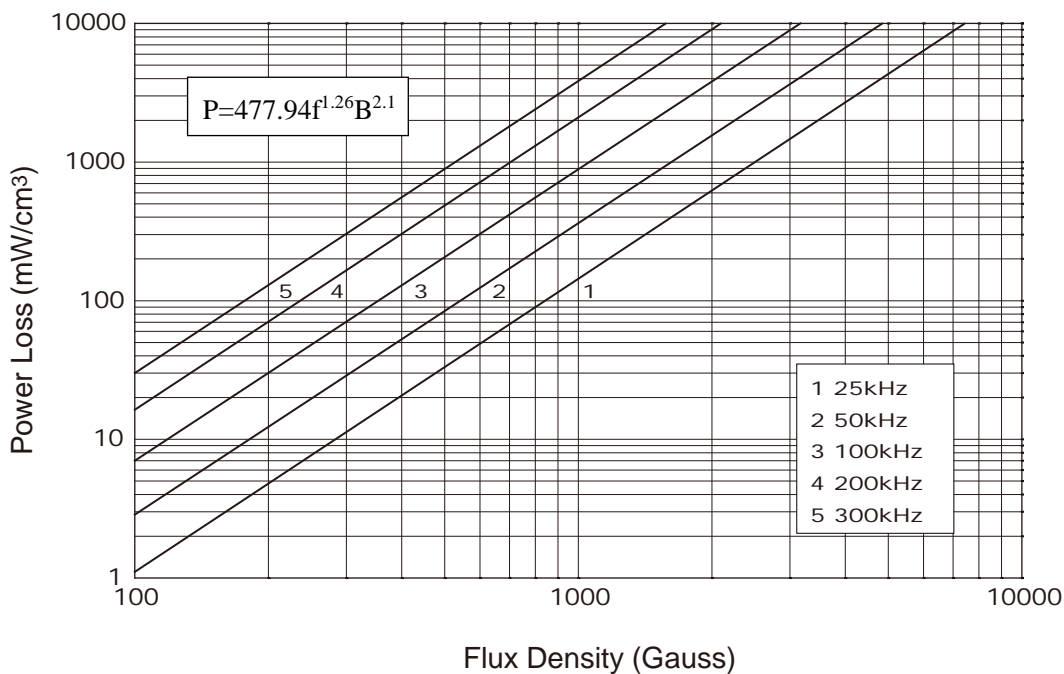

特性曲线 Characteristic Curves

功耗曲线 Curves of Power Loss

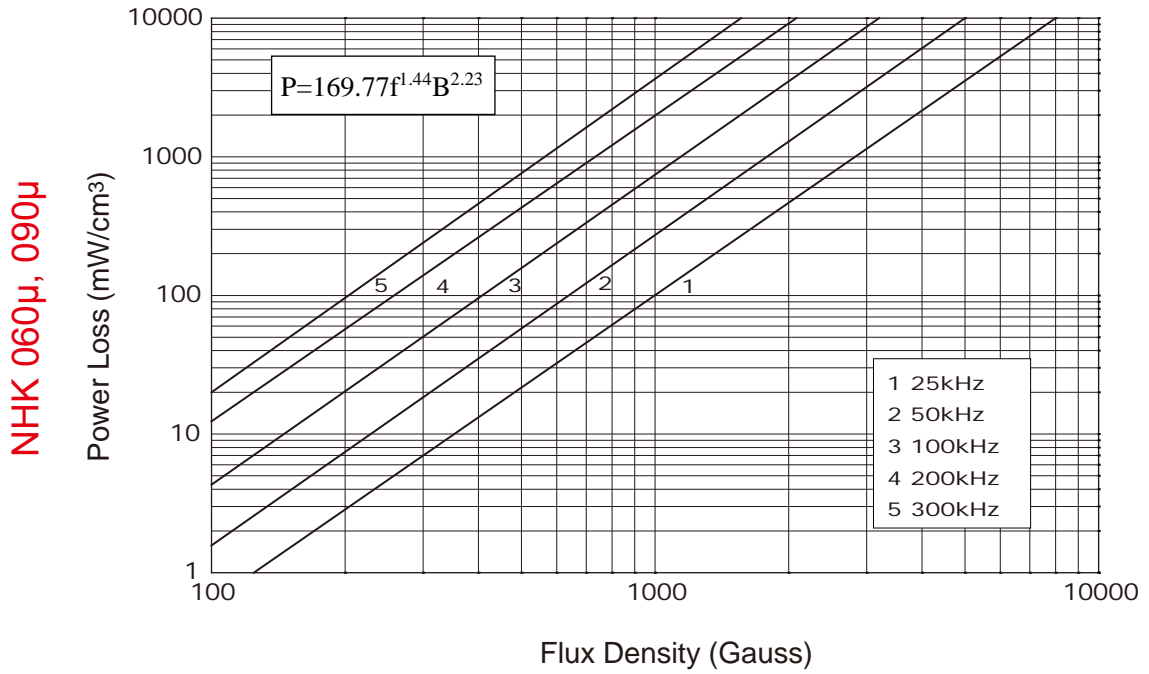

特性曲线 Characteristic Curves

磁导率与频率曲线 Permeability vs Frequency

NS

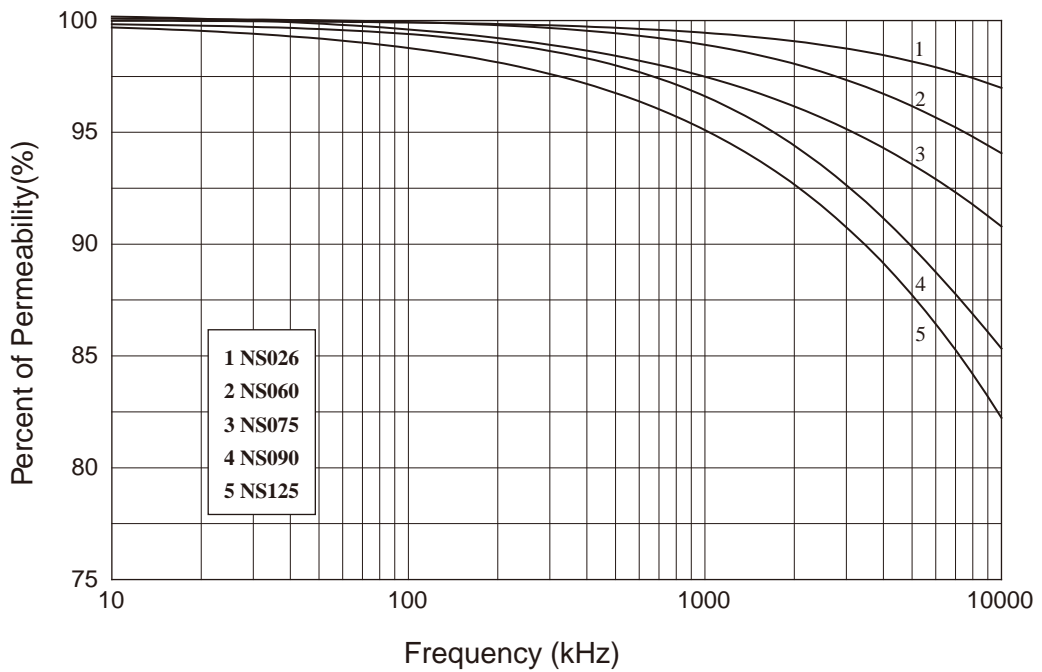

NH

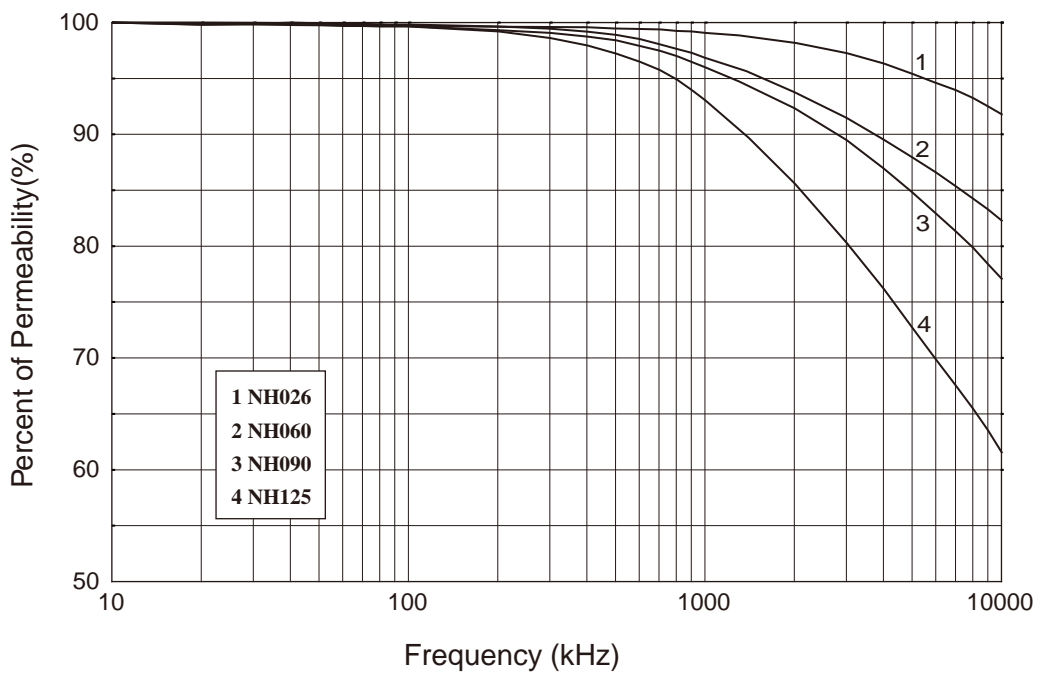

特性曲线

Characteristic Curves

磁导率与频率曲线 Permeability vs Frequency

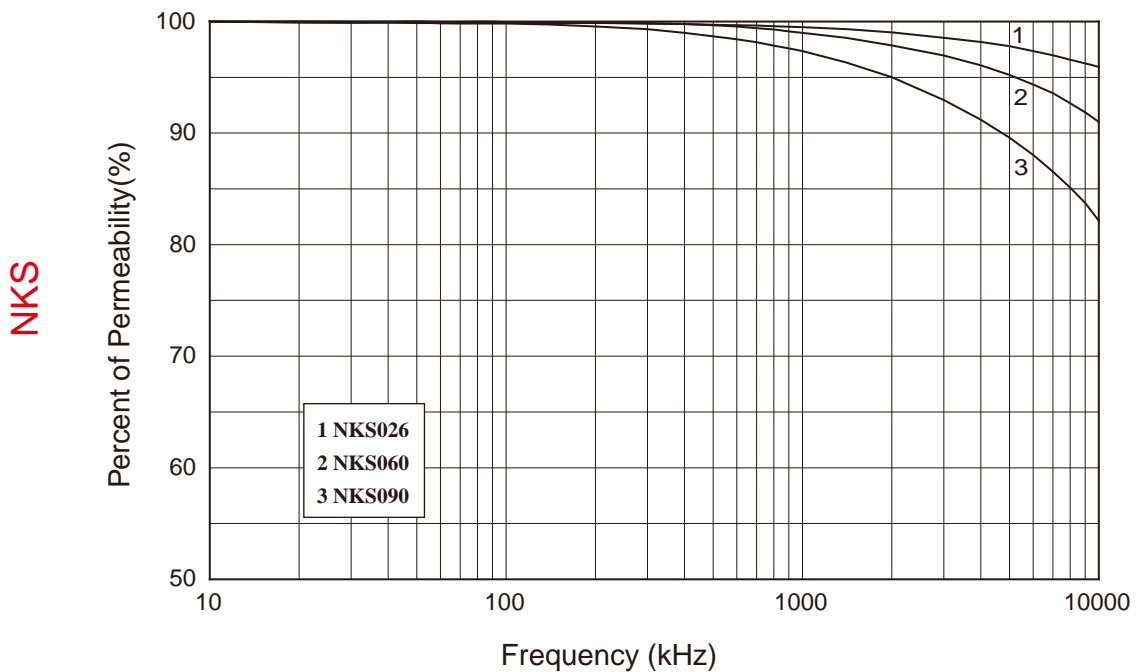
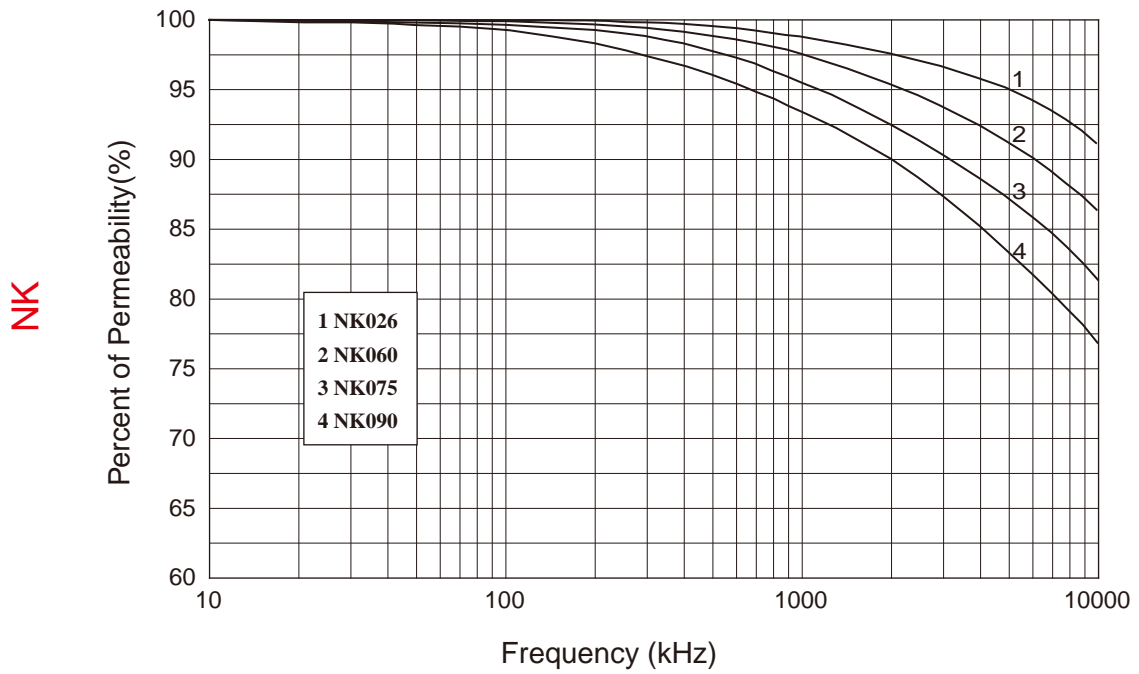

特性曲线 Characteristic Curves

磁导率与频率曲线 Permeability vs Frequency

NSW

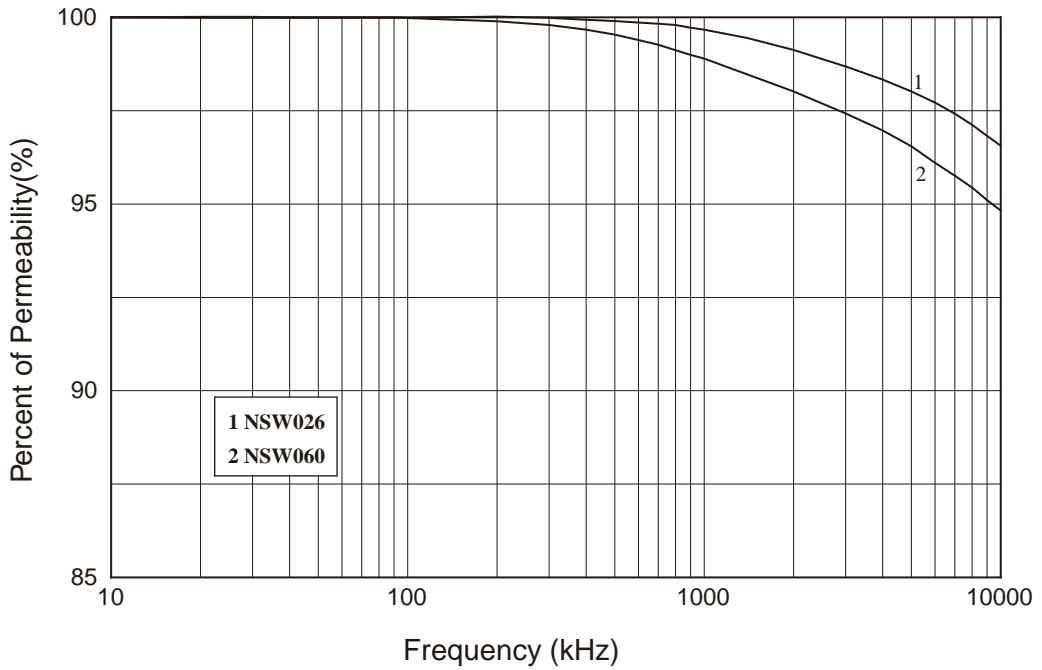

NSWL

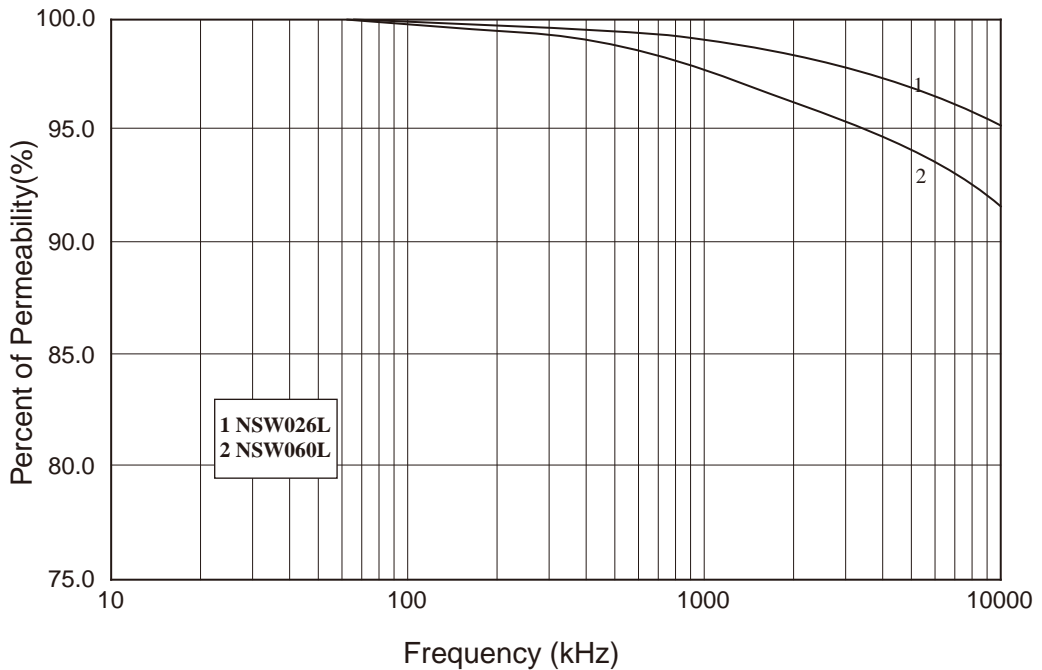

特性曲线

Characteristic Curves

磁导率与频率曲线 Permeability vs Frequency

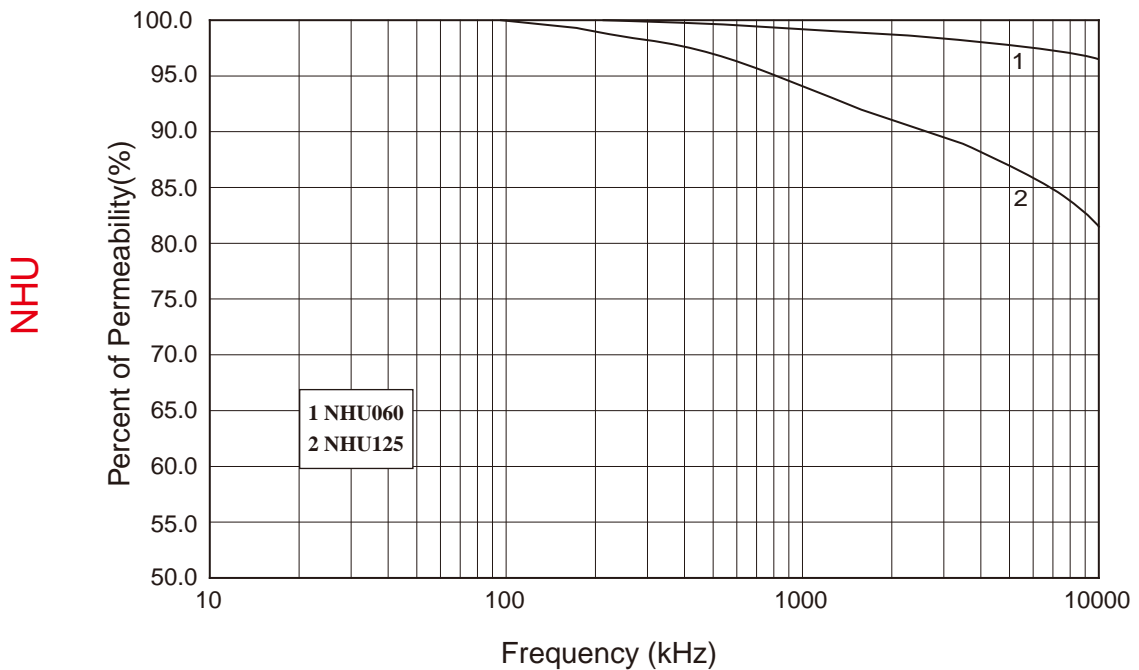
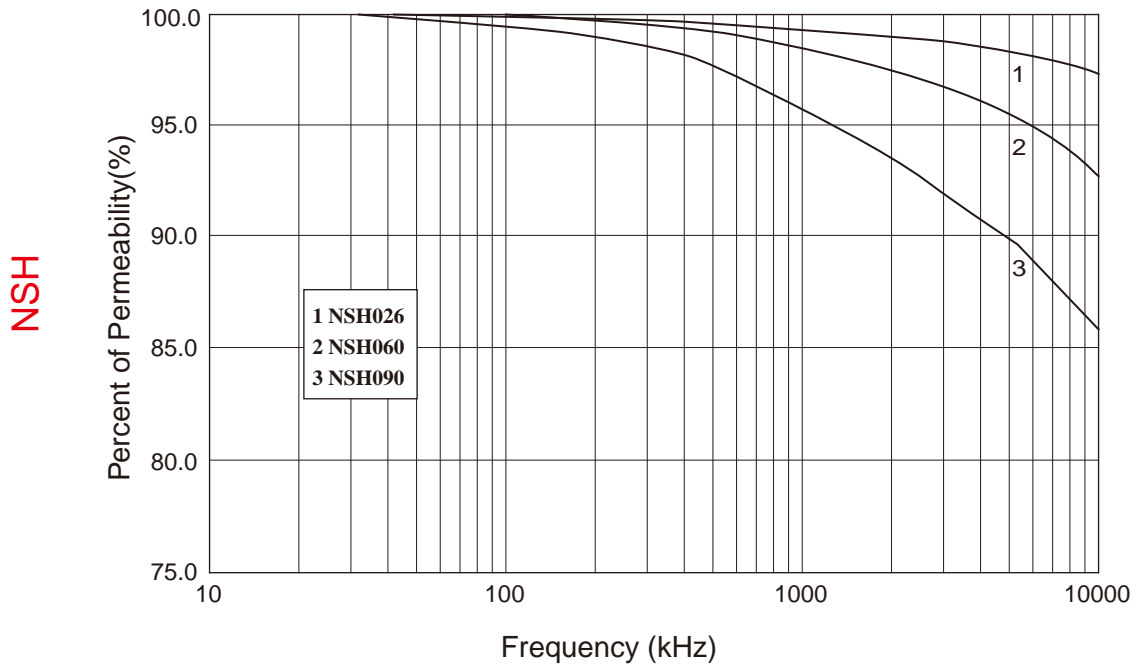

特性曲线 Characteristic Curves

磁导率与频率曲线 Permeability vs Frequency

NHS

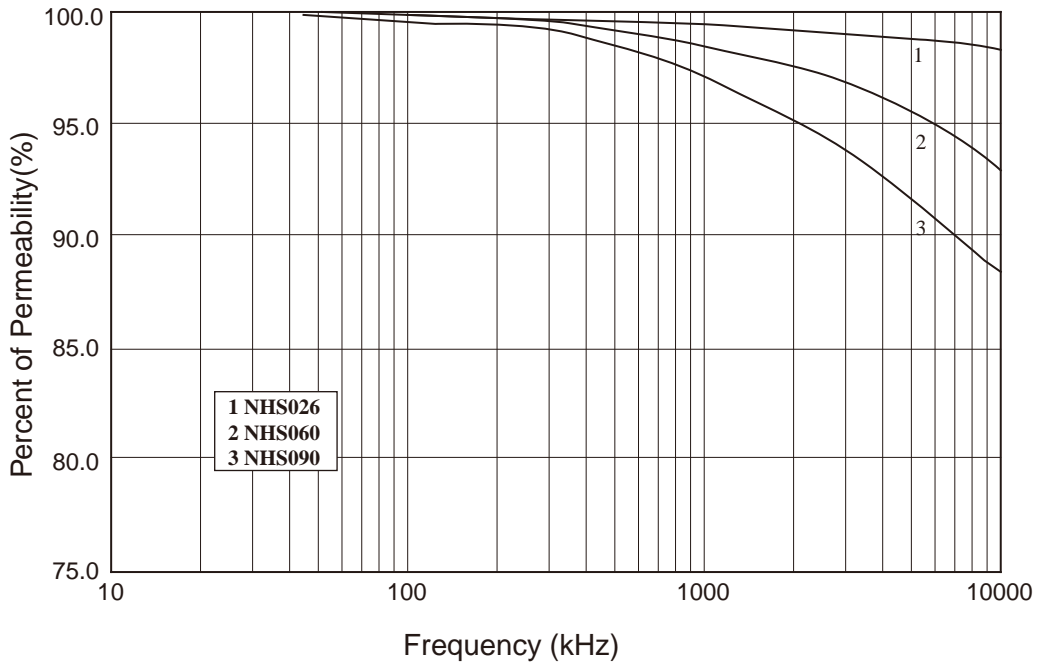

NKH

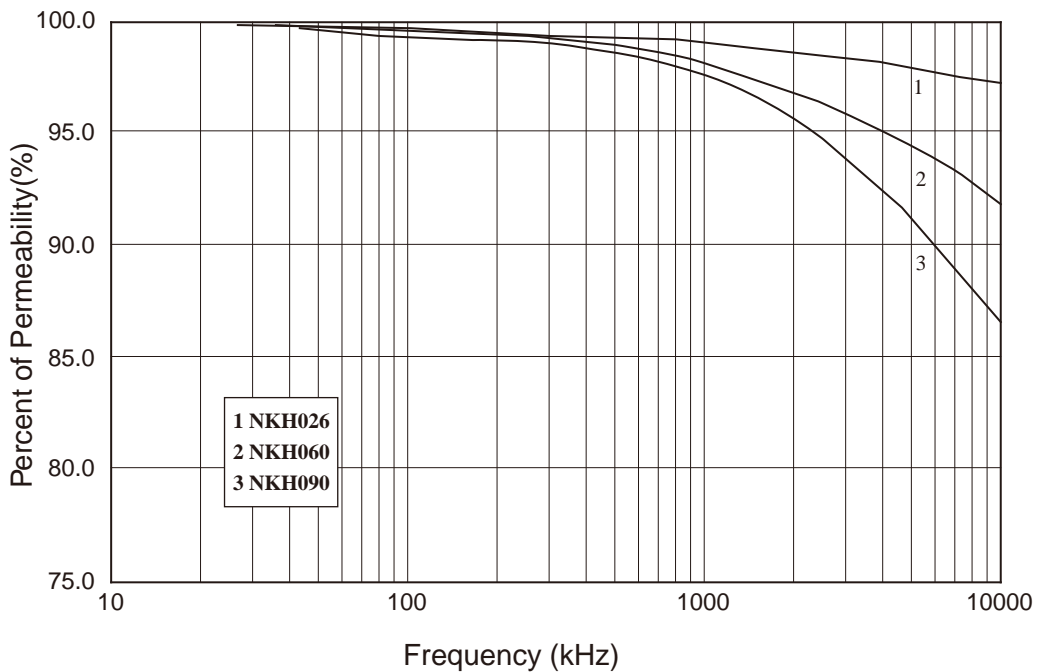

特性曲线

Characteristic Curves

磁导率与频率曲线 Permeability vs Frequency

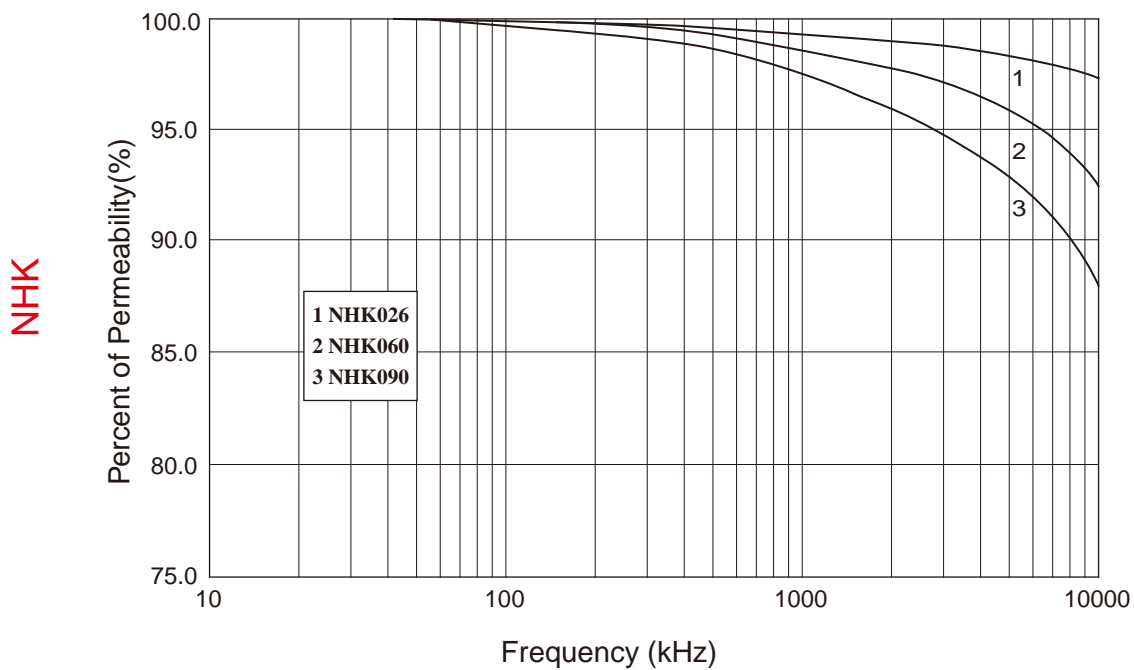

特性曲线 Characteristic Curves

磁导率与温度曲线 Permeability vs Temperature

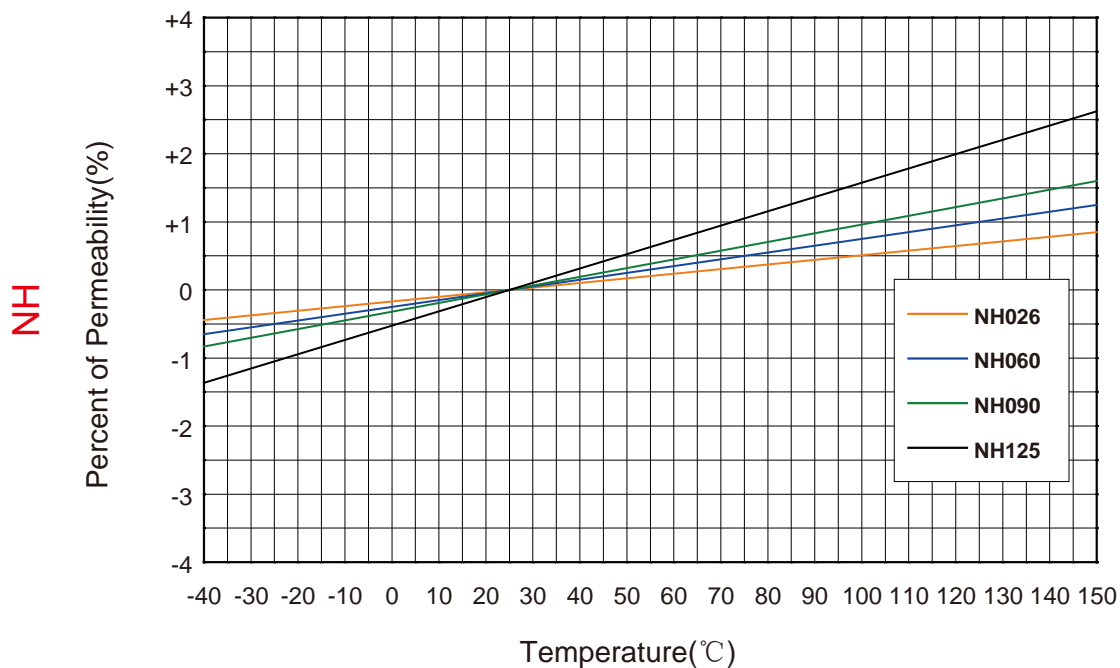
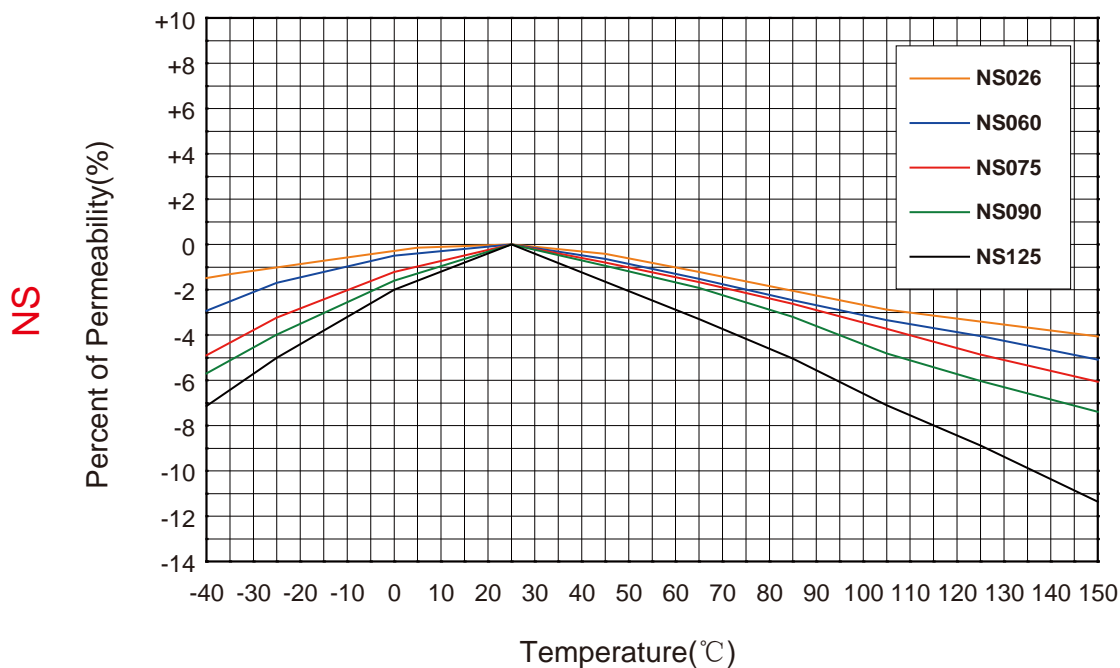

特性曲线

Characteristic Curves

磁导率与温度曲线 Permeability vs Temperature

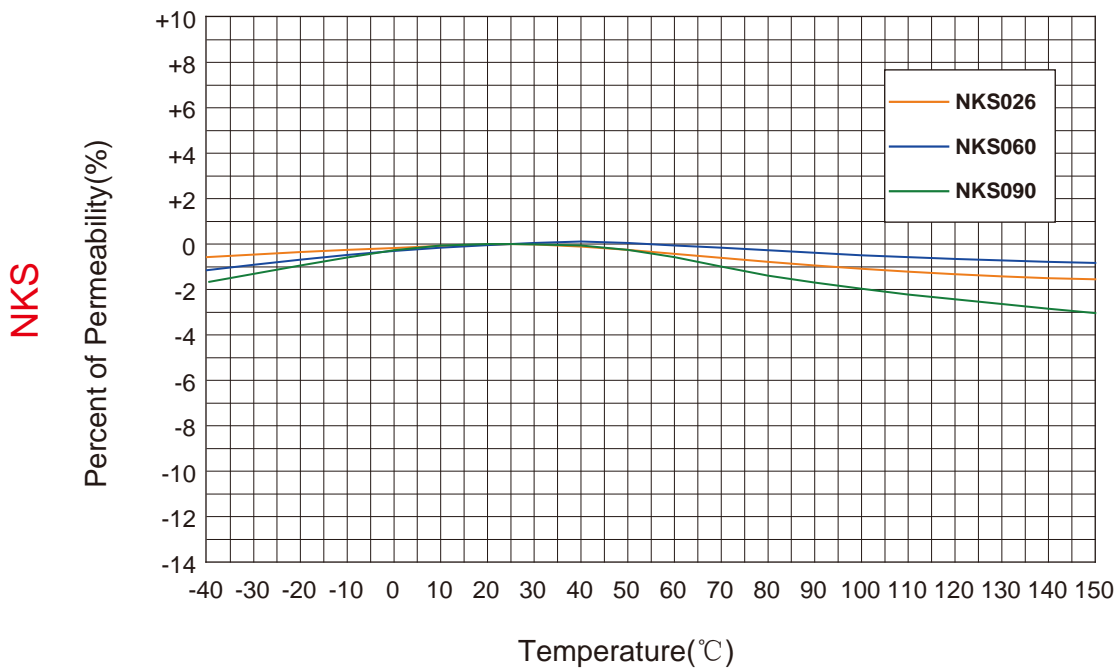
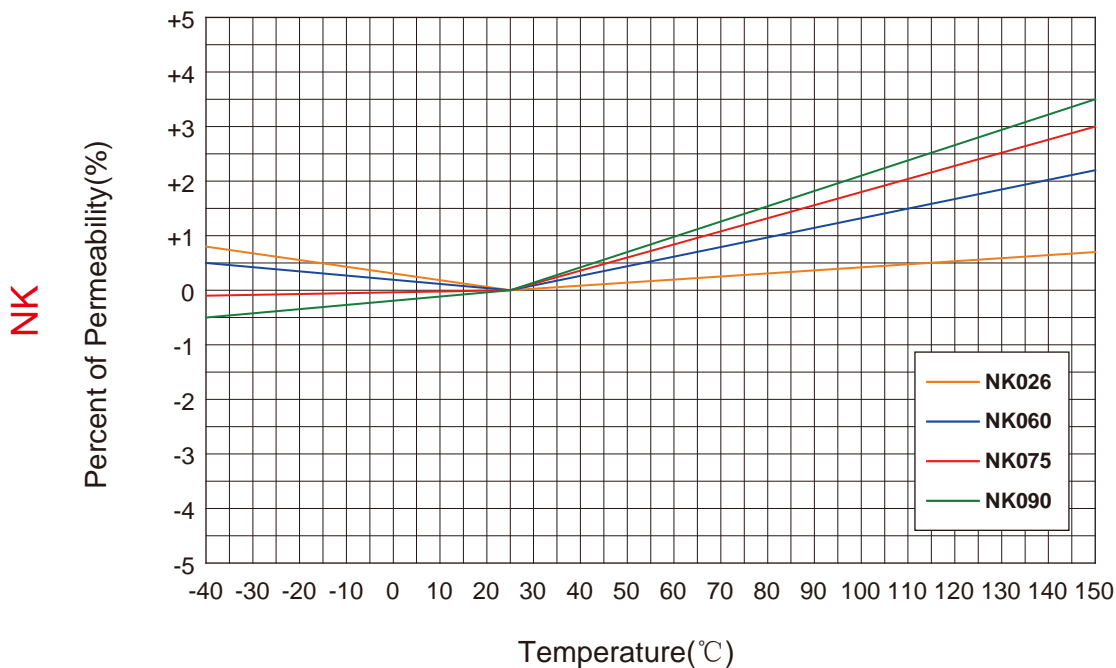

特性曲线 Characteristic Curves

磁导率与温度曲线 Permeability vs Temperature

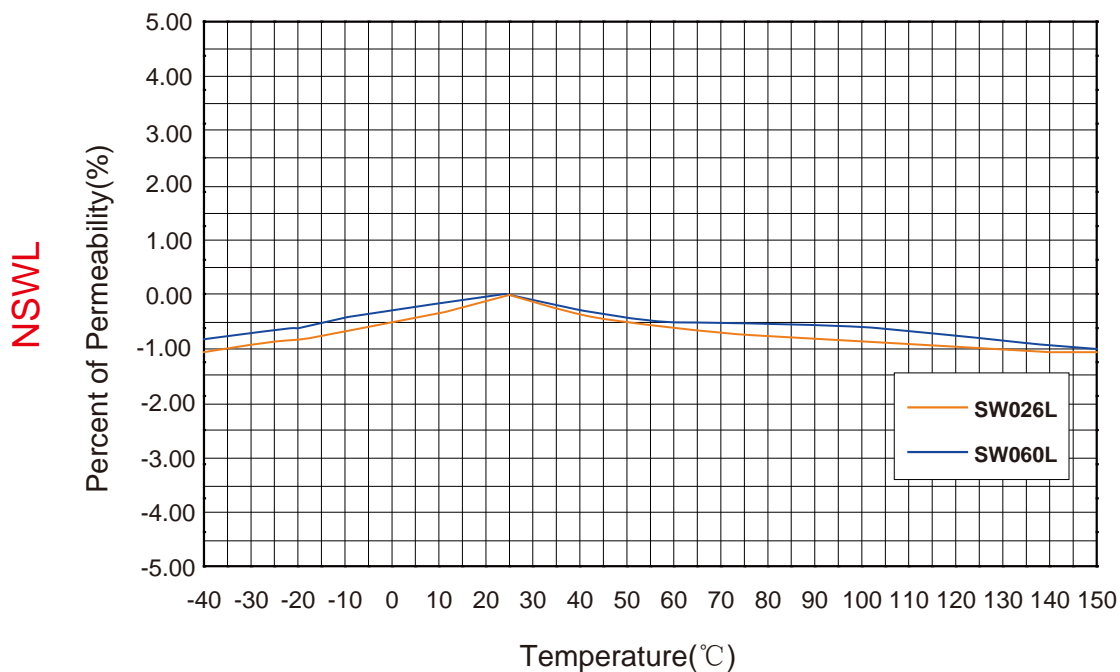
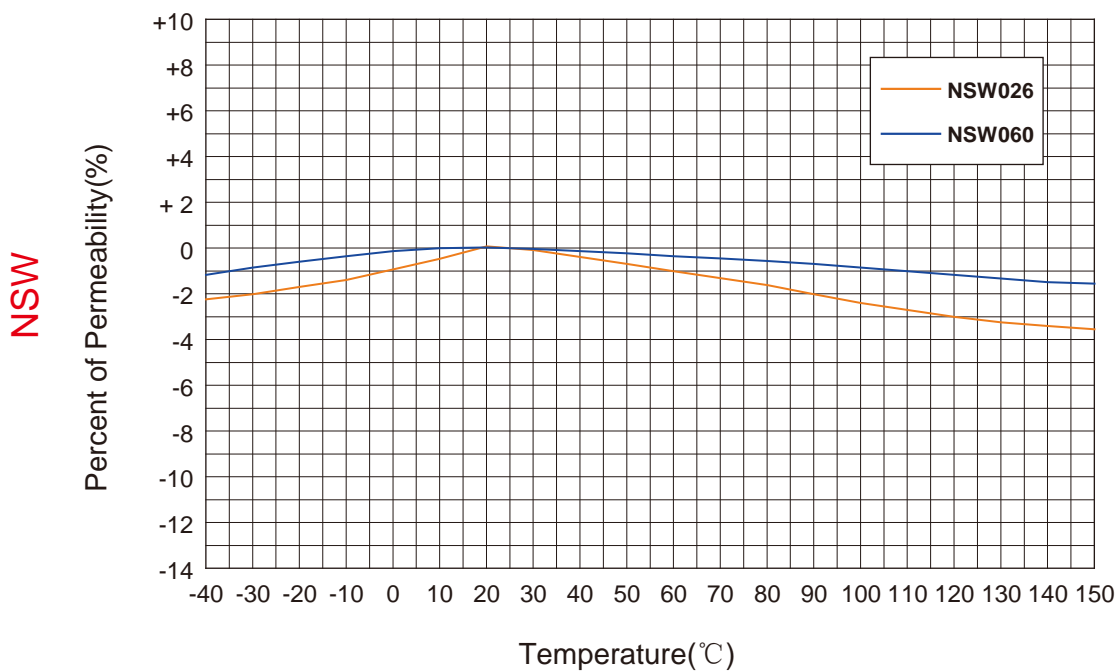

特性曲线

Characteristic Curves

磁导率与温度曲线 Permeability vs Temperature

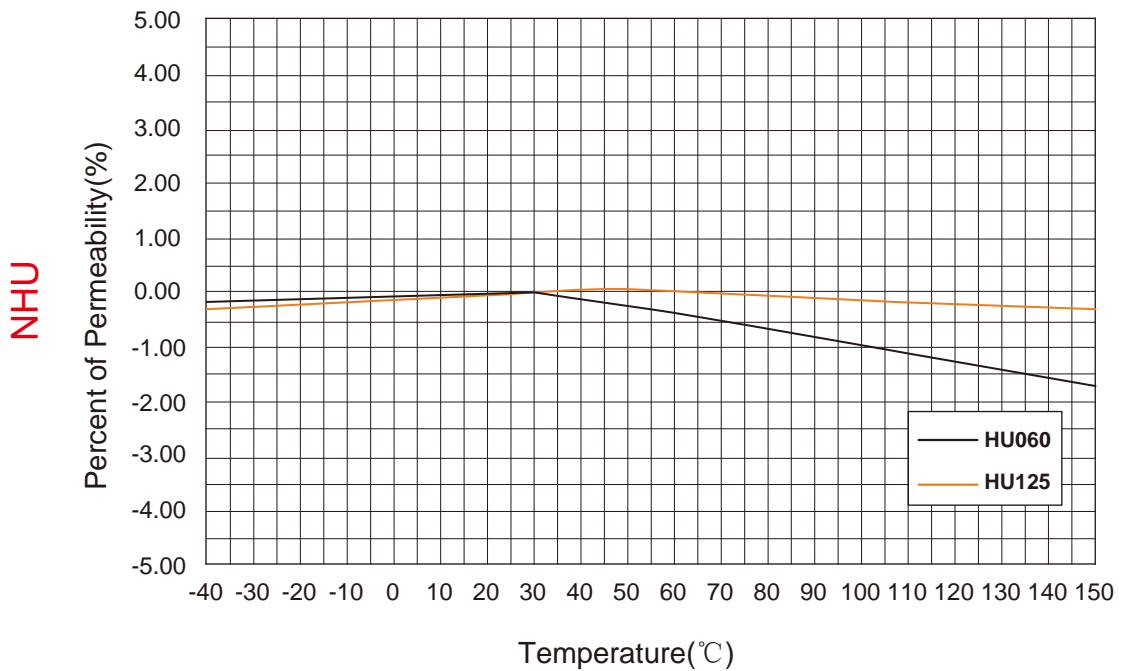
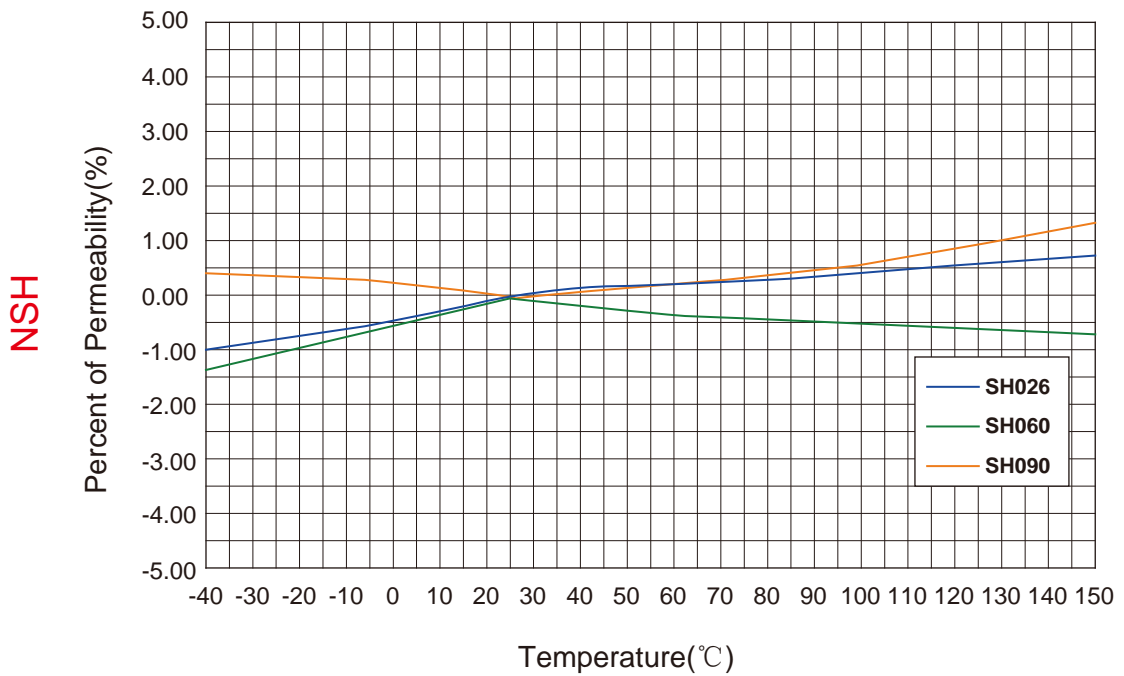

特性曲线 Characteristic Curves

磁导率与温度曲线 Permeability vs Temperature

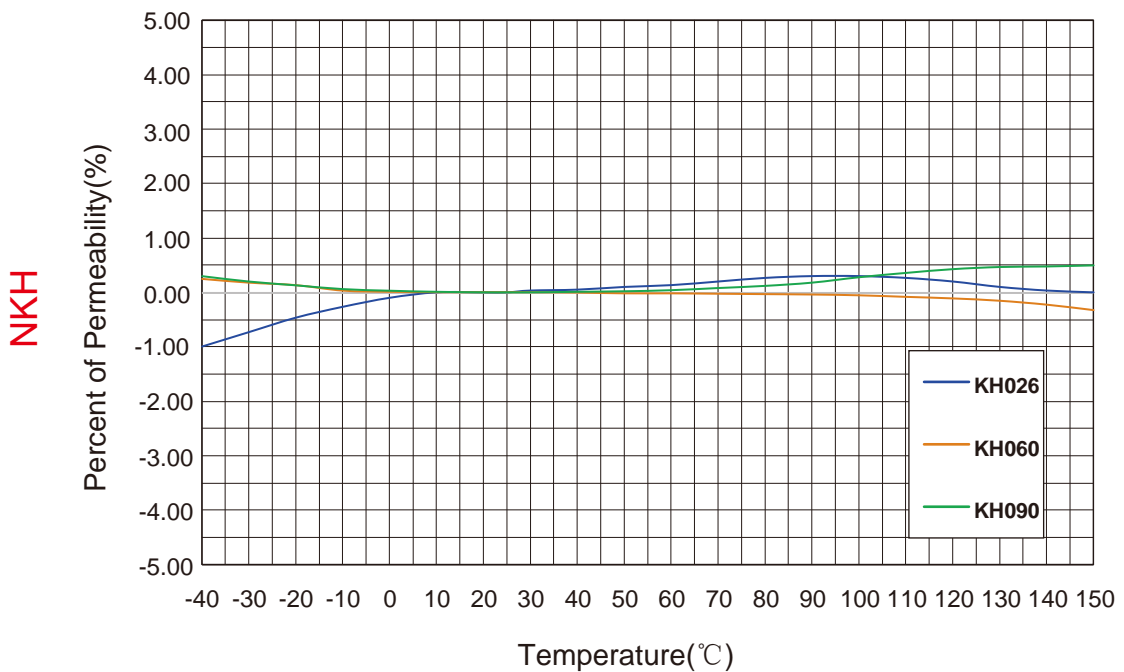
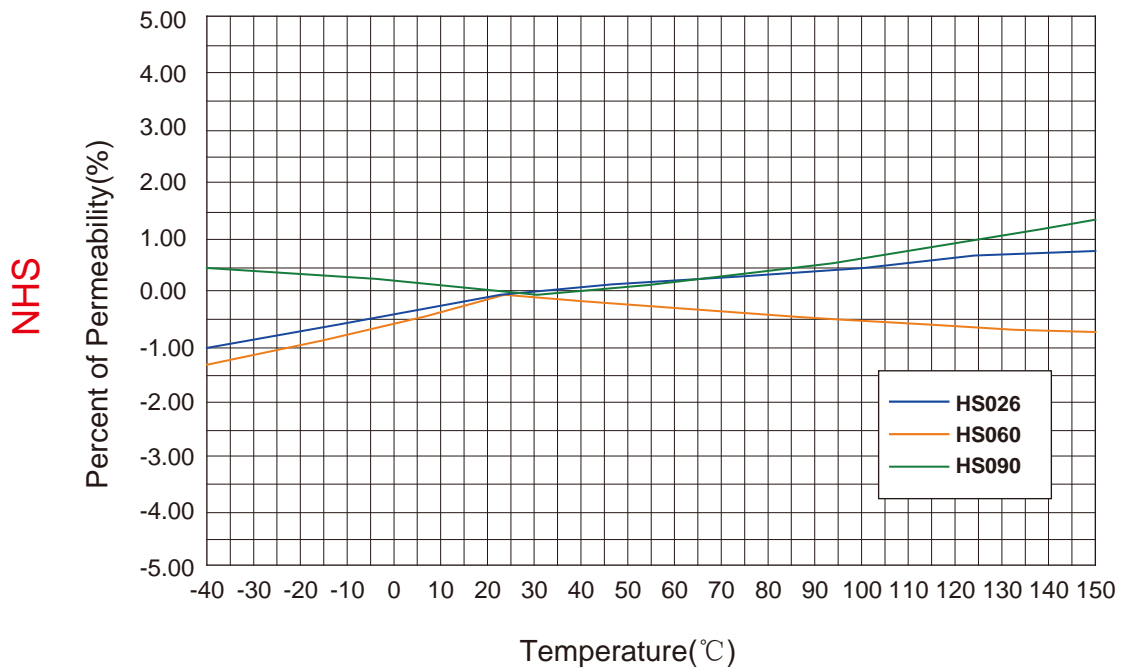

特性曲线

Characteristic Curves

磁导率与温度曲线 Permeability vs Temperature

