

SF₆ gas density monitor

Model: P590 series

Spec. sheet no. PD05-10

Service intended

P590 series monitor are designed to monitor the gas density of closed SF₆ tank for switchgear.



Nominal diameter

100 mm

Accuracy

±1.0 % at ambient temperature +20 °C
±2.5 % at ambient temperature -20 °C ... +60 °C
and calibration pressure as reference isochore

Scale range (MPa, bar)

-0.1 ~ 0.1 MPa to -0.1 ~ 2 MPa
at SF₆ gas pressure +20 °C

Permissible temperature

Ambient : -20 ~ 65 °C (Gas phase)
Storage : -50 ~ 60 °C maximum

High voltage test

2 kV, 50 Hz / wiring versus case

Degree of protection

EN60529/IEC529/IP67

Electrical connection

Cable box with cable gland : M20 x 1.5
Conductor cross - section : Max. 1.5 mm²



Standard features

Pressure connection

Stainless steel (316SS)

Element

Stainless steel (316SS)
<10MPa C type bourdon tube
≥10MPa Helical type bourdon tube

Case

Stainless steel (304SS)

Cover

Stainless steel (304SS)
Bayonet type

Window

Safety glass

Movement

Stainless steel (304SS)
Bimetal link (For environment temperature compensation)

Dial

White aluminium with red, yellow and green graduations

Pointer

Black painted aluminium alloy

Process connection

G¹/₂"

Helium leak rate

Tested to confirm leakage rates of less than
10⁻⁸ mbar-L/sec

1. Base model

P590 SF₆ gas density monitor

2. Contact function (Refer to contact function table)

- 1 Single contact
- 2 Double contact (Common circuit)
- 3 Double contact (Separated circuit)
- 4 Triple contact (Common circuit)
- 5 Triple contact (Separated circuit)

3. Type of mounting

- A Bottom connection, direct
- B Bottom connection, case mounting plate
- G Lower back connection, direct
- L Lower back connection, 4 hole bracket

4. Accuracy

- 3 ±1.0 % of full scale at ambient temperature +20°C

5. Connection type

- EI G½"

6. Unit

- H bar
- I MPa

7. Range

- 000 Special range
- 007 -0.1 ~ -0.15 MPa
- 014 -0.1 ~ 0.9 MPa
- 028 -0.1 ~ 0.2 MPa
- 029 -0.1 ~ 0.3 MPa
- 030 -0.1 ~ 0.4 MPa
- 031 -0.1 ~ 0.6 MPa

8. Pressure connection material and dial colors

- 7 316SS and 5 colors

9. Option

- 0 None
- 1 Silicone filling

1	2	3	4	5	6	7	8	9
P590	2	B	3	EI	H	014	7	0

Sample
ordering code



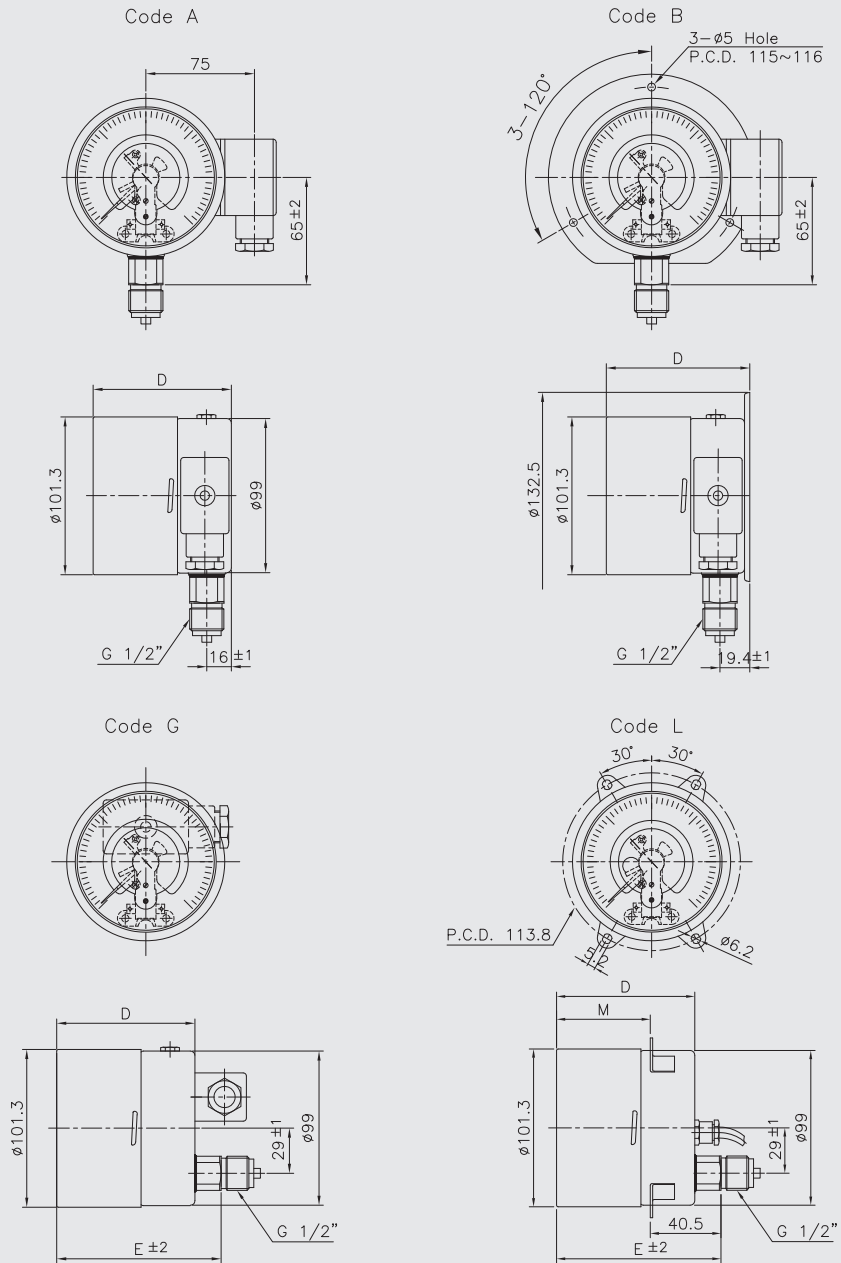



P590 : Type of mounting

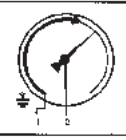
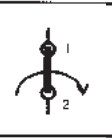
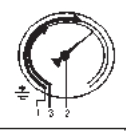
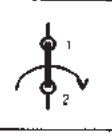
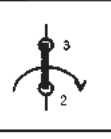
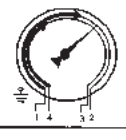
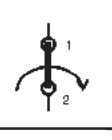
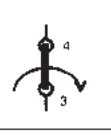
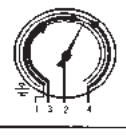

Dimensions (mm)

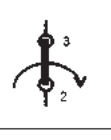
Contact	D±2	E±2	M
Single, Double	88	102.5	62
Double(Separated)	95	109.5	69
Triple	103	117.5	77
Triple(Separated)	111	125.5	85

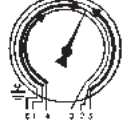
Contact function table

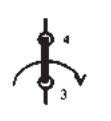
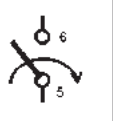
Code	Wiring scheme	Contact function			Wiebrock code no.
		Ps1	Ps2	Ps3	
Single contact					
1	Low alarm - Normal close 				S/M-2
Double contact - Common circuit					
2	1 st low alarm - Normal close 2 nd low alarm - Normal close 				S/M-22
Double contact - Separated circuit					
3	1 st low alarm - Normal close 2 nd low alarm - Normal close 				S/M-S22
Triple contact - Common circuit					
4	1 st low alarm - Normal close 2 nd low alarm - Normal close 3 rd high alarm - Normal open 				S/M-221
Triple contact - Separated circuit					
5	1 st low alarm - Normal close 2 nd low alarm - Normal close 3 rd high alarm - Normal open 				S/M-S221

Snap - action contacts

General

Electromechanical limit switches in pointer type measuring instruments are auxiliary current switches which open or close electrical circuits at set limit values by means of a contact arm which is moved by the actual value pointer.

The snap action contact is a mechanical contact for switching capacities up to 30 W 50 VA max.

Contact making will be delayed and or advanced in relation to the movement of the actual value pointer.

To closed the circuit, the contact pin of the movable contact arm is attracted in a jump by the permanent magnet fastened to the supporting arm shortly before the set value has been reached.

Due to the retention force of the magnet, snap action contacts are more resistant against shock and vibration.

The switching safety is increased by the increased contact pressure.

When the circuit is opened, the magnet keeps the contact arm in its place until the restoring force of the measuring element exceeds the magnetic force, and the contact opens in a jump.

Specifications

Maximum contact rating with non-inductive (ohmic) load		Electric contacts type pressure gauge (Model P590 series)	
		Dry gauges	Liquid filled gauges
Maximum voltage		250 V	250 V
Current ratings	Make ratings	1.0 A	1.0 A
	Break ratings	1.0 A	1.0 A
	Continuos load	0.6 A	0.6 A
Maximum load		30 W 50 VA	20 W 20 VA
Material of contact points		Silver-nickel alloy (80 % Ag / 20 %Ni / 10 µm) gold-plated	
Ambient operating temperature		-20 ...+70 °C	
Max. no. of contacts		2	
Voltage test		Circuit / protective earth conductor - 2,000 vac 1 minute	
		Circuit /circuit - 2,000 vac 1 minute	

Recommended contact ratings with ohmic and inductive load

Voltage (DIN IEC 38) DC / AC	Electric contacts type pressure gauge (Model P590 series)					
	Dry gauges			Liquid filled gauges		
	Ohmic load		inductive load	Ohmic load		inductive load
	DC	AC		DC	AC	
			cosØ > 0.7			cosØ > 0.7
V	mA	mA	mA	mA	mA	mA
220 / 230	100	120	65	65	90	40
110 / 110	200	240	130	130	180	85
48 / 48	300	450	200	190	330	130
24 / 24	400	600	250	250	450	150

In order to ensure a high switching reliability of the contacts the switching voltage should not be below 24 V, also taking environmental influences in the long term into account.

Conversion table

Pressure conversion chart

psi	atm	kgf/cm ²	inH ₂ O	mmHg	inHg	kPa	bar	mmH ₂ O
1	0.068046	0.070307	27.7276	51.715	2.03602	6.835	0.06895	704.28104
14.696	1	1.0332	407.484	760	29.921	101.325	1.01325	10350.0936
14.2233	0.96784	1	394.38	735.559	28.959	98.096	0.98067	10,000
0.036092	0.002454	0.00253	1	1.8651	0.07343	0.249	0.00249	25.4
0.019336	0.001315	0.001359	0.53616	1	0.03937	0.1333	0.001333	13.618464
0.491154	0.0033421	0.03453	13.6185	25.4	1	3.3864	0.033864	345.9099
0.145	0.00987	0.010197	4.0186	7.5006	0.2953	1	0.01	102.07244
14.5038	0.98692	1.01972	402.156	750.062	29.53	100	1	10214.7624
0.00142	0.000097	0.0001	0.03937	0.0734	0.0029	0.0098	0.000098	1

Memo