



Terminal Type



Wiring Type IP67



Harness connector type
5G Antenna power
IP66



Features

- High efficiency up to 95.5% and active PFC function
- Fanless design, cooling by free air convection
- Aluminum case and filling with heat-conducted glue
- Withstand 10G vibration test
- -40 ~ +70°C wide operating range
- Charger function for lead-acid batteries and Li-ion batteries
- Built-in default 2/3 stage charging curves and programmable curve
- Built-in CANBus and PMBus / MODBus by optional
- Output voltage and constant current level programmable
- Protections: Short circuit / Overload / Over voltage / Over temperature
- Built-in remote ON-OFF control and DC OK active signal
- Harness connector type with AC fail and T-Alarm signal
- LED indicator for power on
- Diverse installation scenarios-Mounting methods
- Wiring and Harness connector type with IP67 rating
- 6 years warranty

Applications

- Industrial automation machinery
- Industrial control system
- Mechanical and electrical equipment
- Electronic instruments, equipments or apparatus
- Telecom system(RRU)
- 5G active antenna unit(AAU)

Description

HEP-2300 is a 2300W industrial AC/DC power supply featuring the outstanding capability to operate under highly humid, dusty, oily, and high-vibration harsh environment. The entire series is housed with the aluminum case and fully potted with heat-conducted glue. Adopting the full range 90~305VAC input, the entire series provides an output voltage line of 55V. In addition to the high efficiency up to 95.5%, that the whole series operates from -40°C ~ 70°C under air convection without fan. HEP-2300 has the complete protection functions and 10G anti-vibration capability ; It is complied with the international safety regulations such as TUV EN62368-1 UL62368-1, and design refers to EN61558-1 and EN60335-1. HEP-2300 series serves as a high performance power

Model Encoding

HEP - 2300 - 55 W CAN

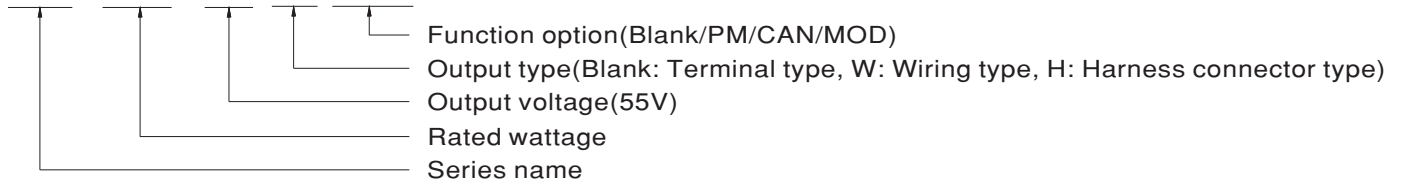

I/O Type	Function type	Communication Protocol	Note
Terminal	Blank	CANBus and PV/PC programmable	In Stock
	PM	PMBus and PV/PC programmable	By request
Wiring	Blank	PV/PC programmable	In Stock
	PM	PMBus	By request
Harness connector	CAN	CANBus	By request
	Blank	CANBus	In Stock
	PM	PMBus	By request
	MOD	MODBus-RTU/RS-485	By request

Note: Charger function by programmer or PMBus/CANBus setting

SPECIFICATION

MODEL		HEP-2300-55 <input type="checkbox"/> <input type="checkbox"/>		
OUTPUT	DC VOLTAGE (factory default)	55V		
	CURRENT (factory default)	41.8A		
	RATED CURRENT (max.)	48A		
	POWER (factory default)	2300W		
	RATED POWER (max.)	2304W		
	FULL POWER VOLTAGE RANGE	48 ~ 57.6V		
	RIPPLE & NOISE (max.) Note.2	480mVp-p		
	VOLTAGE ADJ. RANGE	By potentiometer VR 39 ~ 57.6V		
	VOLTAGE TOLERANCE Note.3	±1.0%		
	LINE REGULATION	±0.5%		
	LOAD REGULATION	±0.5%		
	SETUP, RISE TIME	1800ms, 100ms/230VAC at full load		
HOLD UP TIME (Typ.)	16ms/230VAC at 75% load 12ms/230VAC at full load			
INPUT	VOLTAGE RANGE Note.4	90 ~ 305VAC 250 ~ 431VDC		
	FREQUENCY RANGE	47 ~ 63Hz		
	POWER FACTOR (Typ.)	PF>0.99/115VAC, PF>0.95/230VAC, PF>0.93/277VAC at full load		
	EFFICIENCY (Typ.)	95.5%		
	AC CURRENT (Typ.)	13.3A / 115VAC 11A / 230VAC 9.3A / 277VAC		
	INRUSH CURRENT (Typ.)	Cold start 60A/230VAC		
	LEAKAGE CURRENT	<1.8mA Peak / 240VAC <2mA Peak / 277VAC		
PROTECTION	OVERLOAD	105 ~ 115% rated output power Protection type : Constant current limiting, unit will shutdown after 5 sec. re-power on to recover		
	OVER VOLTAGE	60.5 ~ 69.1V Protection type : Shut down O/P voltage, re-power on to recover		
	OVER TEMPERATURE	Protection type : Shut down O/P voltage, recovers automatically after temperature goes down		
FUNCTION	OUTPUT VOLTAGE PROGRAMMABLE(PV) Note 5	Adjustment of output voltage is allowable to 50 ~ 120% of nominal output voltage Please refer to the Function Manual		
	OUTPUT CURRENT PROGRAMMABLE(PC) Note 5	Adjustment of constant current level is allowable to 20 ~ 100% of rated current Please refer to the Function Manual		
	REMOTE ON/OFF CONTROL	Power ON : Short circuit Power OFF : Open circuit		
	AUXILIARY POWER	12V@0.5A tolerance±10%, ripple 150mVp-p		
	DC-OK SIGNAL	The TTL signal out, PSU turn on = 4.5 ~ 5.5V ; PSU turn off = -0.5 ~ 0.5V. Please refer to the Function Manual		
ENVIRONMENT	WORKING TEMP.	-40 ~ +70°C (Refer to "Derating Curve")		
	WORKING HUMIDITY	20 ~ 95% RH non-condensing		
	STORAGE TEMP., HUMIDITY	-40 ~ +85°C, 10 ~ 95% RH non-condensing		
	TEMP. COEFFICIENT	±0.03%/°C (0 ~ 50°C)		
	VIBRATION	20 ~ 500Hz, 10G 12min./1cycle, period for 72min. each along X, Y, Z axes		
SAFETY & EMC (Note.7)	SAFETY STANDARDS	UL62368-1, TUV BS EN/EN62368-1, EAC TP TC 004 approved; design refers to BS EN/EN61558-1, BS EN/EN60335-1(by request)		
	WITHSTAND VOLTAGE Note 6	OVC III I/P-O/P: 6KVDC I/P-FG:4KVDC O/P-FG:4KVDC		
	ISOLATION RESISTANCE Note 6	I/P-O/P, I/P-FG, O/P-FG:100M Ohms/500VDC/25°C / 70%RH		
	EMC EMISSION	Parameter	Standard	Test Level / Note
		Conducted	BS EN/EN55032 (CISPR32)	Class B
		Radiated	BS EN/EN55032 (CISPR32)	Class A
		Harmonic Current	BS EN/EN61000-3-2	Class A
		Voltage Flicker	BS EN/EN61000-3-3	-----
	EMC IMMUNITY	BS EN/EN55024, BS EN/EN61000-6-2		
		Parameter	Standard	Test Level / Note
ESD		BS EN/EN61000-4-2	Level 3, 8KV air ; Level 2, 4KV contact	
Radiated		BS EN/EN61000-4-3	Level 3	
EFT / Burst		BS EN/EN61000-4-4	Level 3	
Surge		BS EN/EN61000-6-2	2KV/Line-Line 4KV/Line-Earth	
Conducted		BS EN/EN61000-4-6	Level 3	
Magnetic Field		BS EN/EN61000-4-8	Level 4	
	Voltage Dips and Interruptions	BS EN/EN61000-4-11	>95% dip 0.5 periods, 30% dip 25 periods, >95% interruptions 250 periods	
OTHERS	MTBF	478K hrs min. Telcordia SR-332 (Bellcore) ; 44.8K hrs min. MIL-HDBK-217F (25°C)		
	DIMENSION	375*280*88mm (L*W*H)		
	PACKING	12.5Kg		
NOTE	<ol style="list-style-type: none"> All parameters NOT specially mentioned are measured at 230VAC input, rated load and 25°C of ambient temperature. Ripple & noise are measured at 20MHz of bandwidth by using a 12" twisted pair-wire terminated with a 0.1uf & 47uf parallel capacitor. Tolerance includes set up tolerance, line regulation and load regulation. Derating may be needed under low input voltages. Please check the derating curve for more details. SVR function is disabled during PV/PC programming operation. During withstand standards voltage and isolation resistance testing, the screw "A" shall be temporarily removed, and shall be installed back after the testing. The power supply is considered a component which will be installed into a final equipment. All the EMC tests are been executed by mounting the unit on a 1100mm*650mm metal plate with 1mm of thickness. The final equipment must be re-confirmed that it still meets EMC directives. For guidance on how to perform these EMC tests, please refer to "EMI testing of component power supplies." (as available on http://www.meanwell.com) The ambient temperature derating of 3.5°C/1000m with fanless models and of 5°C/1000m with fan models for operating altitude higher than 2000m(6500ft). <p>※ Product Liability Disclaimer : For detailed information, please refer to https://www.meanwell.com/serviceDisclaimer.aspx</p>			



SPECIFICATION FOR CHARGER (Option function)

MODEL		HEP-2300-55 <input type="checkbox"/> <input type="checkbox"/>		
OUTPUT	BOOST CHARGE VOLTAGE V _{boost}	57.6V		
	FLOAT CHARGE VOLTAGE V _{float}	55.2V		
	RECOMMENDED BATTERY CAPACITY(AMP HOURS)(Note 2)	120 ~ 400AH		
	BATTERY TYPE	Open & Sealed Lead Acid		
	OUTPUT CURRENT (max.)	40A		
INPUT	VOLTAGE RANGE <small>Note 3</small>	90 ~ 305VAC	250 ~ 431VDC	
	FREQUENCY RANGE	47 ~ 63Hz		
	POWER FACTOR (Typ.)	PF>0.99/115VAC, PF>0.95/230VAC, PF>0.93/277VAC at full load		
	EFFICIENCY (Typ.)	95.5%		
	AC CURRENT (Typ.)	13.3A / 115VAC	11A / 230VAC	9.3A / 277VAC
	INRUSH CURRENT(Typ.)	Cold start 60A at 230VAC		
	LEAKAGE CURRENT	<1.8mA Peak / 240VAC	<2mA Peak / 277VAC	
PROTECTION	SHORT CIRCUIT	Constant current limiting, unit will shutdown after 5 sec, re-power on to recover.		
	OVER VOLTAGE	60.5 ~ 69.1V	Protection type :Shut down O/P voltage,re-power on to recover	
	OVER TEMPERATURE	Protection type :Shut down O/P voltage, recovers automatically after temperature goes down		
FUNCTION	REMOTE ON/OFF CONTROL	Power ON : Short circuit Power OFF : Open circuit		
	AUXILIARY POWER	12V @ 0.5A tolerance ±10%, ripple=150mVp-p		
	DC-OK SIGNAL	The TTL signal out, PSU turn on = 4.5 ~ 5.5V ; PSU turn off = -0.5 ~ 0.5V. Please refer to the Function Manual.		
ENVIRONMENT	WORKING TEMP.	-40 ~ +70°C (Refer to "Derating Curve")		
	WORKING HUMIDITY	20 ~ 95% RH non-condensing		
	STORAGE TEMP., HUMIDITY	-40 ~ +80°C, 10 ~ 95% RH non-condensing		
	TEMP. COEFFICIENT	±0.03%/°C (0 ~ 50°C)		
	VIBRATION	20 ~ 500Hz, 10G 12min./1cycle, period for 72min. each along X, Y, Z axes		
SAFETY & EMC (Note.4)	SAFETY STANDARDS	UL62368-1,TUV BS EN/EN62368-1, EAC TP TC 004 approved; design refers to BS EN/EN61558-1, BS EN/EN60335-1(by request)		
	WITHSTAND VOLTAGE	OVC III I/P-O/P: 6KVDC I/P-FG:4KVDC O/P-FG:4KVDC		
	ISOLATION RESISTANCE	I/P-O/P, I/P-FG,O/P-FG:100M Ohms/500VDC/25°C / 70%RH		
	EMC EMISSION	Parameter	Standard	Test Level / Note
		Conducted	BS EN/EN55032 (CISPR32)	Class B
		Radiated	BS EN/EN55032 (CISPR32)	Class A
		Harmonic Current	BS EN/EN61000-3-2	Class A
		Voltage Flicker	BS EN/EN61000-3-3	----
	EMC IMMUNITY	BS EN/EN55024, BS EN/EN61000-6-2		
		Parameter	Standard	Test Level / Note
		ESD	BS EN/EN61000-4-2	Level 3, 8KV air ; Level 2, 4KV contact
		Radiated	BS EN/EN61000-4-3	Level 3
		EFT / Burst	BS EN/EN61000-4-4	Level 3
		Surge	BS EN/EN61000-6-2	2KV/Line-Line 4KV/Line-Earth
Conducted		BS EN/EN61000-4-6	Level 3	
Magnetic Field		BS EN/EN61000-4-8	Level 4	
Voltage Dips and Interruptions	BS EN/EN61000-4-11	>95% dip 0.5 periods, 30% dip 25 periods, >95% interruptions 250 periods		
OTHERS	MTBF	478K hrs min. Telcordia SR-332 (Bellcore) ; 44.8K hrs min. MIL-HDBK-217F (25°C)		
	DIMENSION	375*280*88mm (L*W*H)		
	PACKING	12.5Kg		
NOTE	<ol style="list-style-type: none"> All parameters NOT specially mentioned are measured at 230VAC input, rated load and 25°C of ambient temperature. This is Mean Well's suggested range. Please consult your battery manufacturer for their suggestions about maximum charging current limitation. Derating may be needed under low input voltages. Please check the derating curve for more details. The power supply is considered a component which will be installed into a final equipment. All the EMC tests are been executed by mounting the unit on a 720mm*360mm metal plate with 1mm of thickness. The final equipment must be re-confirmed that it still meets EMC directives. For guidance on how to perform these EMC tests, please refer to "EMI testing of component power supplies." (as available on http://www.meanwell.com) The ambient temperature derating of 3.5°C/1000m with fanless models and of 5°C/1000m with fan models for operating altitude higher than 2000m(6500ft). <p>※ Product Liability Disclaimer : For detailed information, please refer to https://www.meanwell.com/serviceDisclaimer.aspx</p>			

■ BLOCK DIAGRAM

PFC fosc : 80KHz
PWM fosc : 52KHz

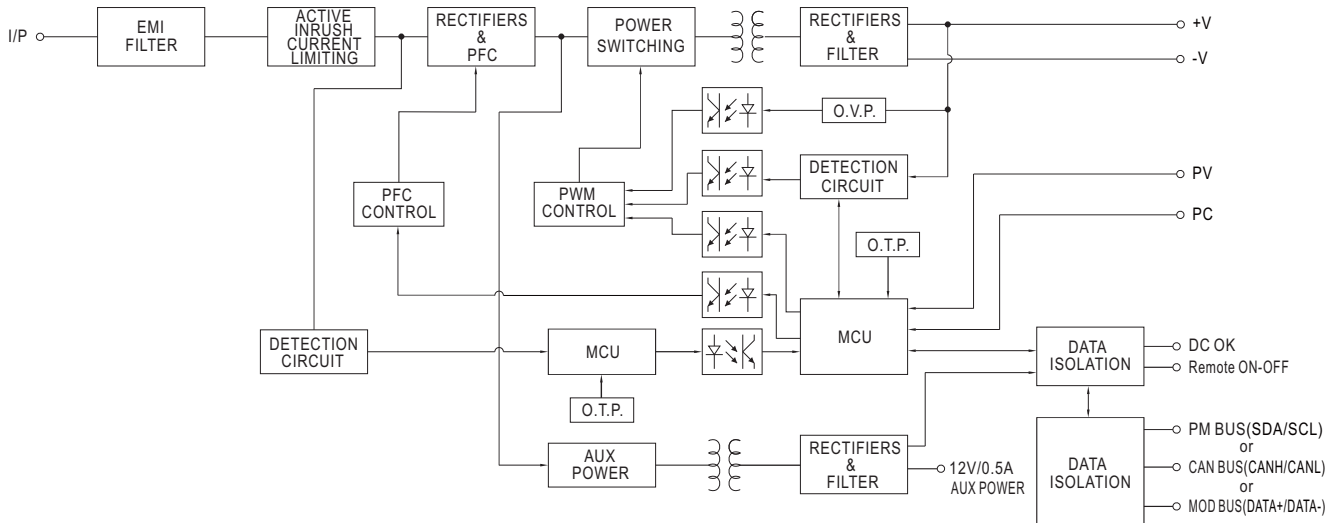

■ DERATING CURVE

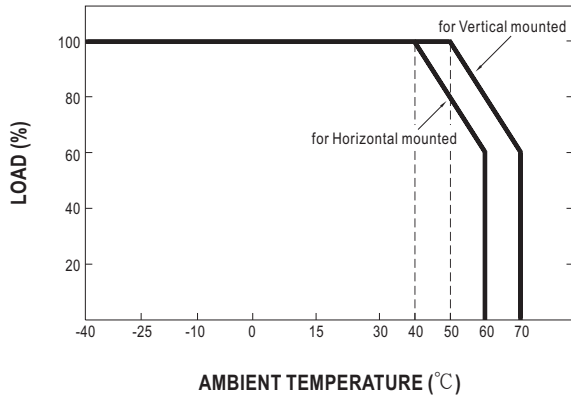

■ STATIC CHARACTERISTICS

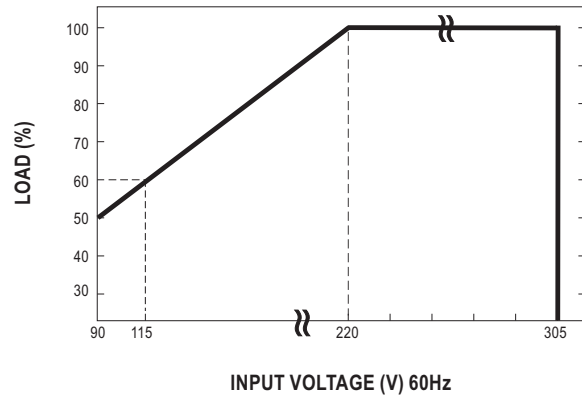

■ TABLE OF FUNCTION

I/O TYPE	Function type	Power Supply Function	Charging Function	PV/PC Programmable	PMBus Protocol	CANBus Protocol	MOD RS-485	LED Indicator	Remote On/Off	DC-OK Signal	Temperature Compensation	12V/0.5A Aux. output	AC Fail	T-Alarm OK Signal
Terminal type	Blank	V(default)	V	V		V		V	V	V	V	V		
	PM	V(default)	V	V	V			V	V	V	V	V		
Wiring type	Blank	V(default)	V	V				V		V		V		
	PM	V(default)	V		V			V		V		V		
	CAN	V(default)	V			V		V		V		V		
Harness connector	Blank	V(default)	V			V		V	V	V		V	V	V
	PM	V(default)	V		V			V	V	V		V	V	V
	MOD	V(default)	V				V	V	V	V		V	V	V

FUNCTION MANUAL

1. Charging Curve

- ※ By default, the HEP-2300 operates in power supply mode, and it can be configured to charger mode by PMBus, CANBus, or SBP-001.
- ※ By factory default, this charger performs the default curve which can be programmed via PMBus and CANBus.
- ※ To accommodate the parameters of the charging curve, SBP-001, the smart battery charging programmer designed by MEAN WELL, and a personal computer are needed. Please contact MEAN WELL for details.

※ 2 stage charging curve (default)

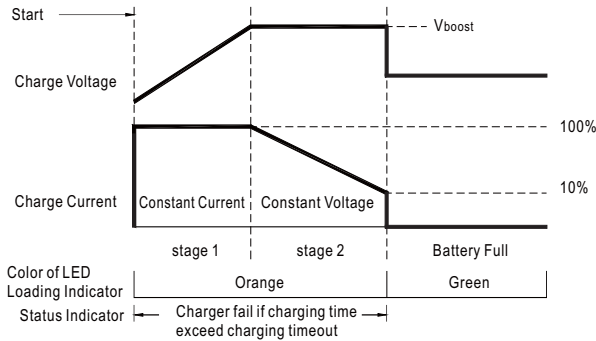

☉ Suitable for lead-acid batteries (flooded, Gel and AGM) and Li-ion batteries (lithium iron and lithium manganese).

※ 3 stage charging curve

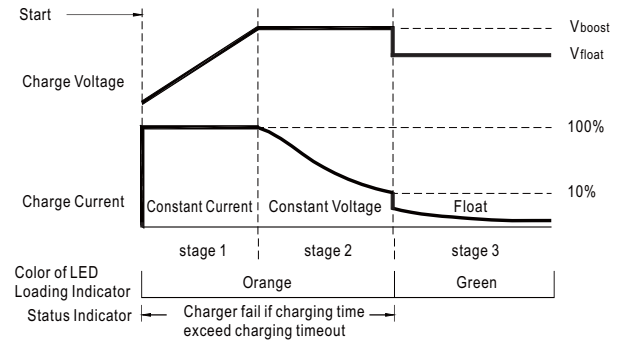

☉ Suitable for lead-acid batteries (flooded, Gel and AGM) and Li-ion batteries (lithium iron and lithium manganese).

2. Front Panel LED Indicators & Corresponding Signal at Function Pins

LED	Description
Green	Float (stage 3)
Orange	Charging (stage 1 or stage 2)
Red	Abnormal status (OTP, OLP, Charging timeout.)
Red (Flashing)	The LED will flash with the red light when the internal temperature reaches 95°C; under this condition, the unit still operates normally without entering OTP. (In the meantime, an alarm signal will be sent out through the PMBus interface.)

3. Output Voltage Programming (or, PV / remote voltage programming / remote adjust / margin programming / dynamic voltage trim)

- ※ In addition to the adjustment via the built-in potentiometer, the output voltage can be trimmed by applying EXTERNAL VOLTAGE.

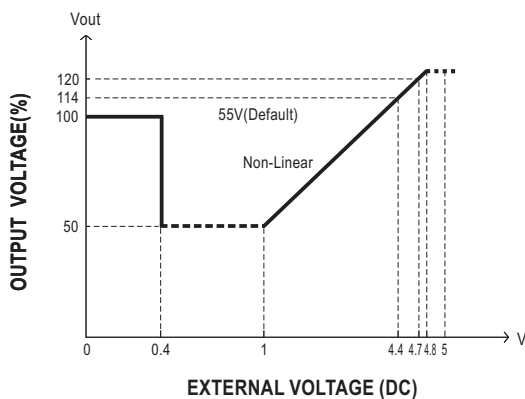
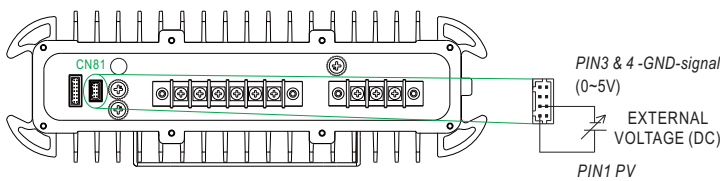

☉ The 100% output voltage is 48V.

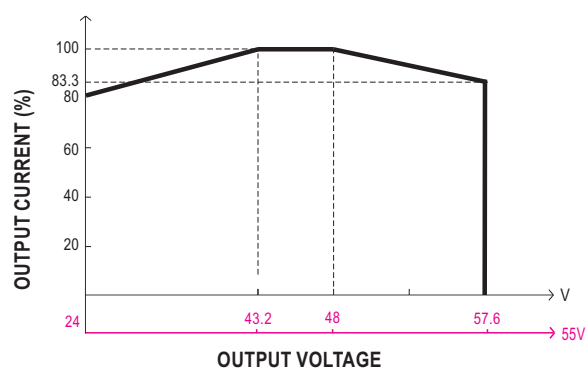

☉ The rated current should change with the Output Voltage Programming accordingly.

4. Output Current Programming (or, PC / remote current programming / dynamic current trim)

※ The output current can be trimmed to 20~100% of the rated current by applying EXTERNAL VOLTAGE.

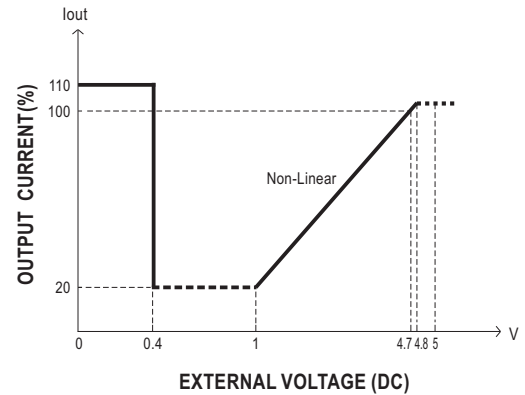
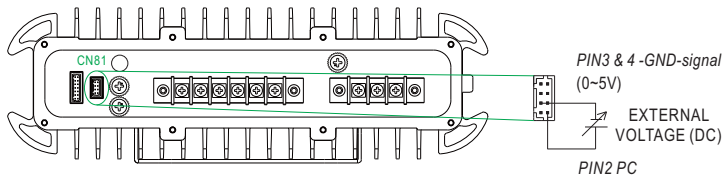

- ◎ The 100% output current is rated current.
- ◎ Maximum operation current <100% is recommended.

5. Temperature Compensation

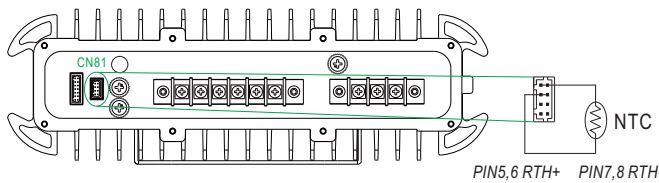

- ◎ To exploit the temperature compensation function, please attach the temperature sensor, NTC, which is enclosed with the charger, to the battery or the battery's vicinity.
- ◎ The charger is able to work normally without the NTC.

6. Remote ON-OFF Control

The power supply can be turned ON/OFF individually or along with other units in parallel by using the "Remote ON-OFF" function.

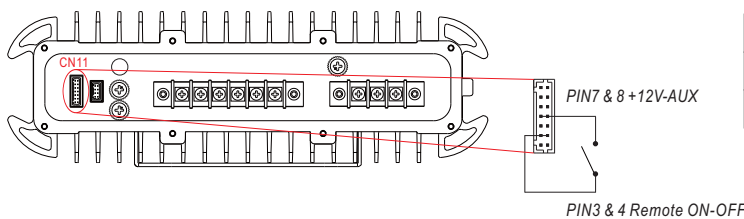

Remote ON-OFF	Power Supply Status
Short circuit	ON
Open circuit	OFF

7. DC-OK Signal

DC-OK signal is a TTL level signal. The maximum source current is 10mA and the maximum external voltage is 5.5V.

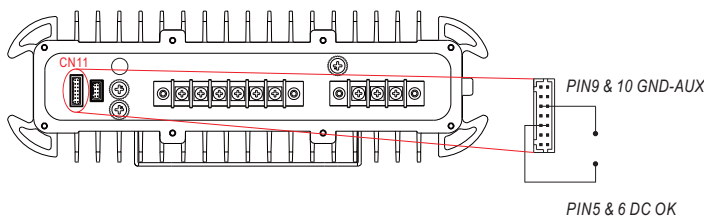

DC-OK signal	Power Supply Status
"High" >4.4~5.5V	ON
"Low" <-0.5~0.5V	OFF

8. CANBus Communication Interface

HEP-2300 supports CANBus Rev. 1.1 with maximum 250KHz bus speed, allowing information reading, status monitoring, output trimming, etc. For details, please refer to the User's Manual.

9. AC FAIL SIGNAL

Dry contact output, Open: alarm; Closed: normal.

10. OTP SIGNAL

Dry contact output, Open: normal; Closed: alarm.

MECHANICAL SPECIFICATION

※Blank-Type (Terminal type)

Case No. 293A

Unit:mm

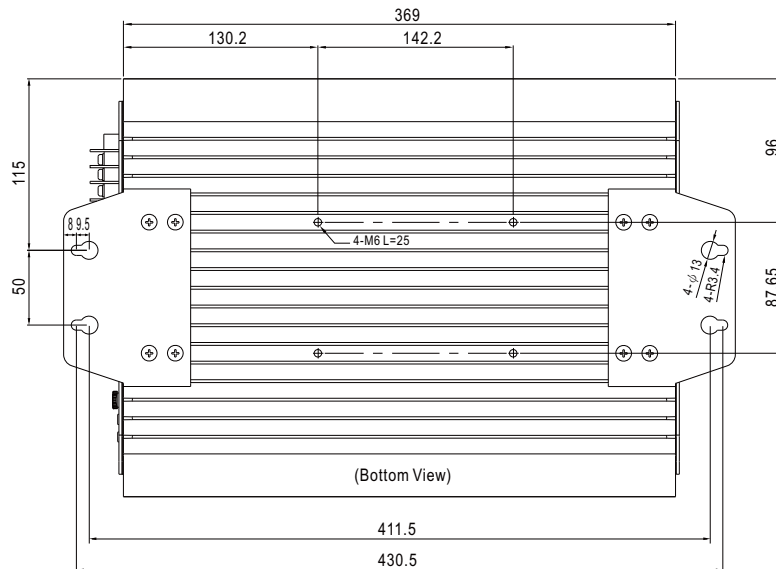
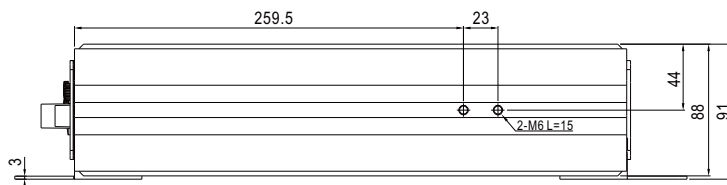
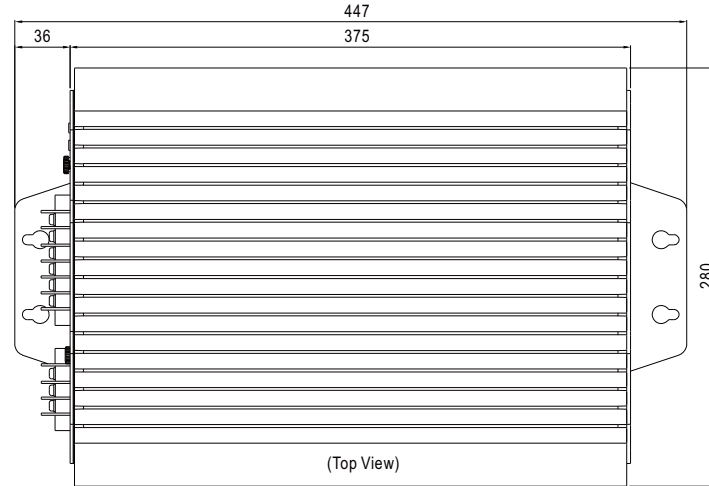
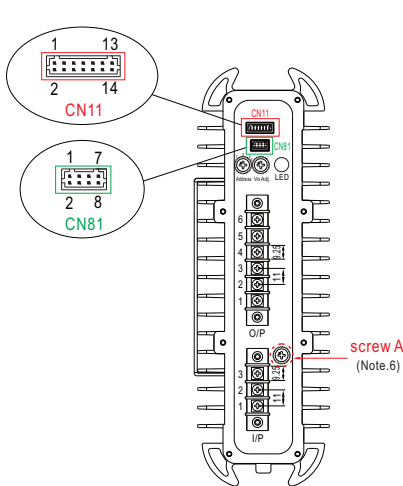

- ※ Output voltage current level can be adjusted through internal potentiometer.(Vo Adj.)
(Can access by removing the rubber stopper on the case.)
- ※ PMBus interface address selection.(Address)

AC Input Terminal Pin No. Assignment

Pin No.	Assignment
1	FG (⊖)
2	AC/L
3	AC/N

DC Output Terminal Pin No. Assignment

Pin No.	Assignment
1,2,3	+V
4,5,6	-V

※Control Pin No. Assignment(CN81) : JST S8B-PHDKS-B or equivalent



Mating Housing	JST PHDR-8VS or equivalent
Terminal	JST SPHD-001T-P0.5 or equivalent

Pin No.	Function	Description
1	PV	Connection for output voltage programming. (Note)
2	PC	Connection for constant current level programming. (Note)
3,4	GND (Signal)	Negative output voltage signal.
5,6	RTH+	Temperature sensor(NTC, 5KOhm) comes along with the charger can be connected to the unit to allow temperature compensation of the charging voltage.
7,8	RTH-	

Note: Non-isolated signal, referenced to [GND(signal)].

※Control Pin No. Assignment(CN11) : JST S14B-PHDKS-B or equivalent

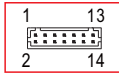

Mating Housing	JST PHDR-14VS or equivalent
Terminal	JST SPHD-001T-P0.5 or equivalent

Pin No.	Function	Description
1,2,13,14	NC	-----
3,4	Remote ON-OFF	The unit can turn the output ON/OFF by dry contact between Remote ON/OFF and +12V-AUX. (Note) Short (10.8 ~ 13.2V) : Power ON ; Open(0 ~ 0.5V) : Power OFF ; The maximum input voltage is 13.2V
5,6	DC-OK	Low (-0.5 ~ 0.5V) : When $V_{out} \leq 77\% \pm 6\%$ at power mode. $V_{out} \leq 66\% \pm 6\%$ at charger mode. High (4.4 ~ 5.5V) : When $V_{out} \geq 80\% \pm 6\%$ at power mode. $V_{out} \geq 67\% \pm 6\%$ at charger mode. The maximum sourcing current is 10mA and only for output. (Note)
7,8	+12V-AUX	Auxiliary voltage output, 10.8~13.2V, referenced to GND-AUX (pin9 & 10). The maximum load current is 0.5A. This output is not controlled by "Remote ON-OFF".
9,10	GND-AUX	Auxiliary voltage output GND. The signal return is isolated from the output terminals (+V & -V).
11	SDA	For PMBus model: Serial Data used in the PMBus interface. (Note)
	CANH	For CANBus model: Data line used in CANBus interface. (Note)
12	SCL	For PMBus model: Serial Clock used in the PMBus interface. (Note)
	CANL	For CANBus model: Data line used in CANBus interface. (Note)

Note: Isolated signal, referenced to GND-AUX.

※W-Type (Wiring type)

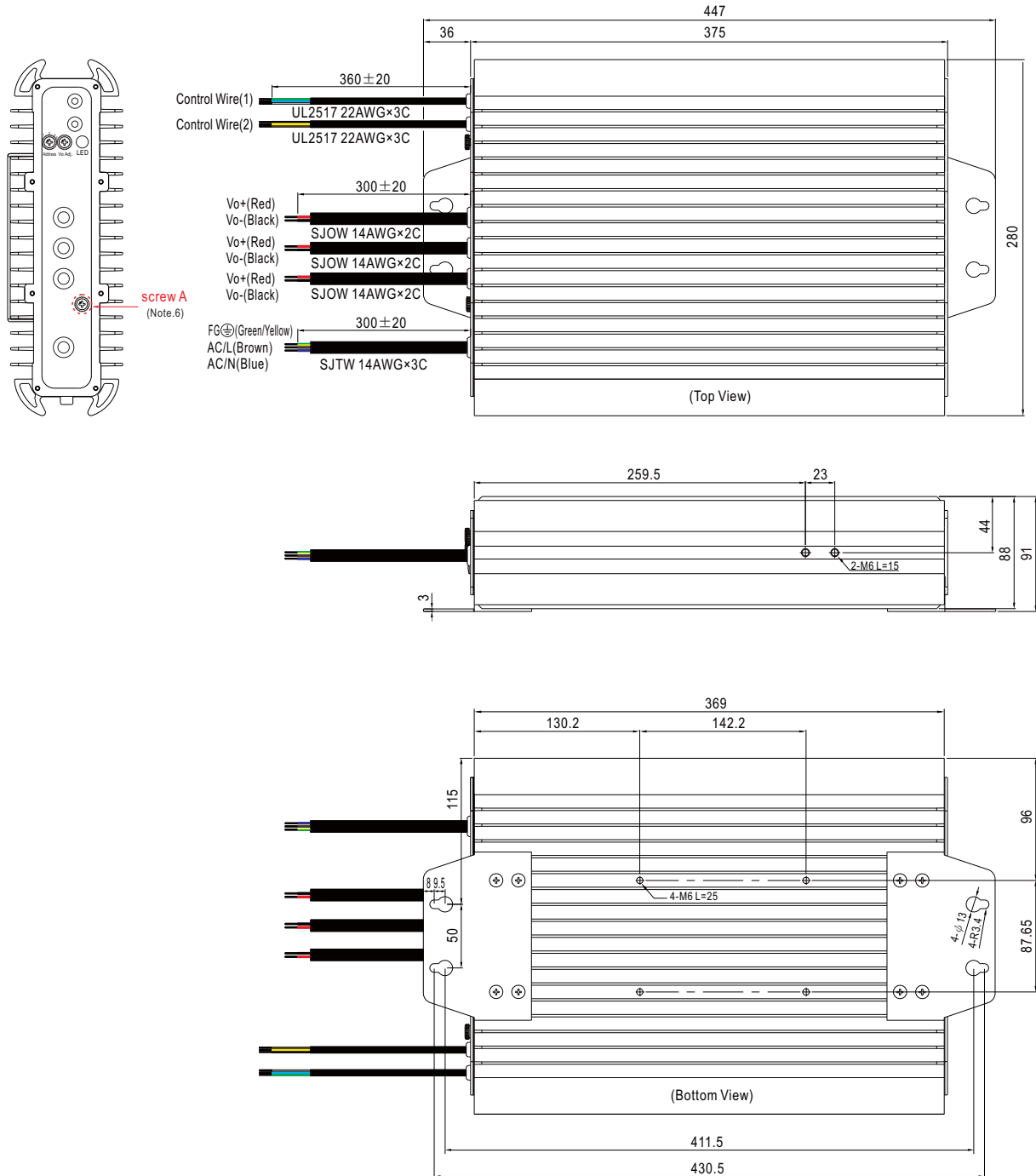

※ Control Wire Assignment(1) : UL2517 24AWG×3C for Blank

Color	Function	Description
Green	PV	Connection for output voltage programming.(Note.1)
Blue	PC	Connection for constant current level programming.(Note.1)
White	GND (Signal)	Negative output voltage signal.(PV/PC GND)

※Control Wire Assigment(1) : UL2517 24AWG×3C for PM/CAN

Color	Function	Description
Green	SDA	For PMBus model: Serial Data used in the PMBus interface. (Note.2)
	CANH	For CANBus model: Data line used in CANBus interface. (Note.2)
Blue	SCL	For PMBus model: Serial Clock used in the PMBus interface. (Note.2)
	CANL	For CANBus model: Data line used in CANBus interface. (Note.2)
White	GND-AUX	Auxiliary voltage output GND. The signal return is isolated from the output terminals (+V & -V).

※Control Wire Assigment(2) : UL2517 24AWG×3C

Color	Function	Description
Brown	DC-OK	Low (0 ~ 0.5V) : When $V_{out} \leq 77\% \pm 6\%$ at power mode. $V_{out} \leq 66\% \pm 6\%$ at charger mode.
		High (4.4 ~ 5.5V) : When $V_{out} \geq 80\% \pm 6\%$ at power mode. $V_{out} \geq 67\% \pm 6\%$ at charger mode. The maximum sourcing current is 10mA and only for output.(Note.2)
Yellow	+12V-AUX	Auxiliary voltage output, 10.8~13.2V, referenced to GND-AUX. The maximum load current is 0.5A.
Black	GND-AUX	Auxiliary voltage output GND. The signal return is isolated from the output terminals (+V & -V).

Note1: Non-isolated signal, referenced to [GND(signal)].

Note2: Isolated signal, referenced to GND-AUX (GND for CANBus and PMBus protocol).

※H-Type (Harness connector type)

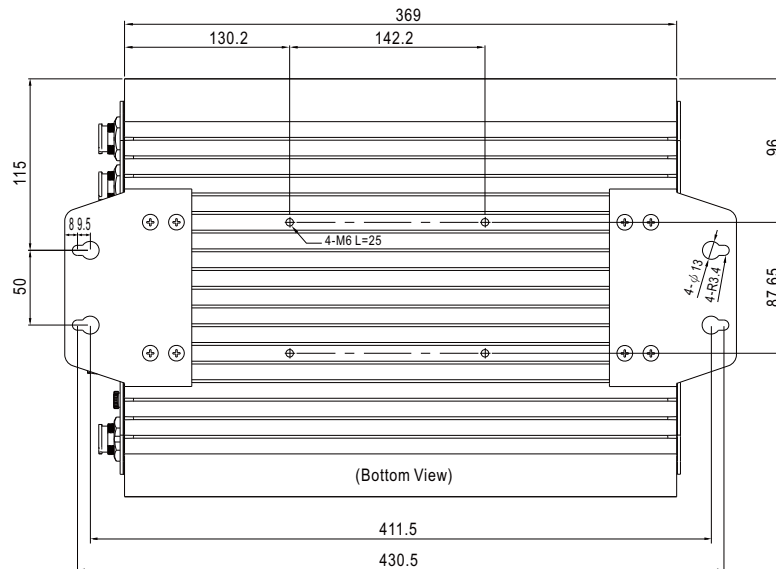
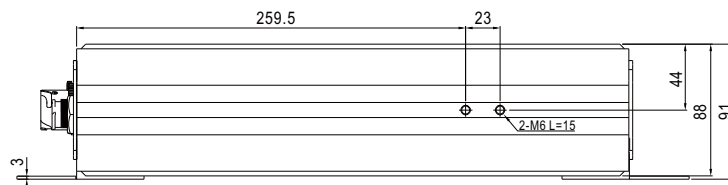
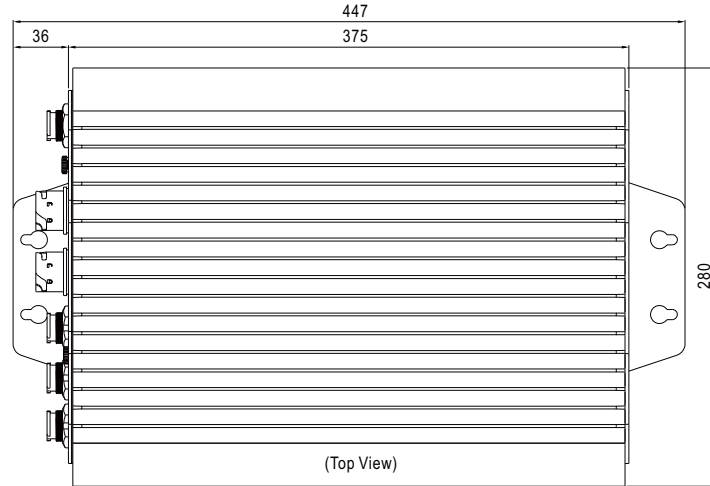
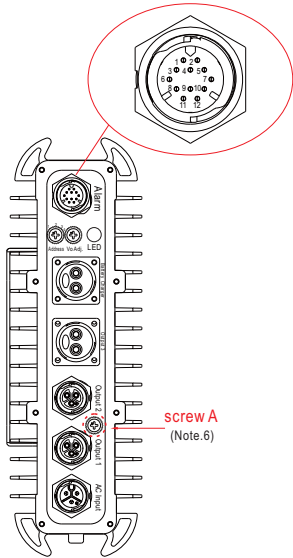

AC Input



Max. 20A

Output 1



Max. 20A

Output 2



Max. 20A

Output 3



Max. 50A

Battery Charger



Max. 50A

AC Input Pin No. Assignment :

ALTW CC-03PMMS-QC800P or equivalent

Pin No.	Assignment	Mating connector
1	AC/L	CC-03BFFA-QL8APP or equivalent
2	FG \oplus	
3	AC/N	

DC Output 1,2 Pin No. Assignment :

ALTW CC-03PMFS-QC800P or equivalent

Pin No.	Assignment	Mating connector
1,3	+V	CC-03BFMA-QL8APP or equivalent
2	-V	

DC Output 3, Battery Charger Pin No. Assignment :

ALTW PWM-02RMFS-TS7001 or equivalent

Pin No.	Assignment	Mating connector
1	+V	PWM-02BFMB-TL7001 or equivalent
2	-V	

※Control Pin No. Assignment : ALTW CD-12PMMS-QC8001 or equivalent

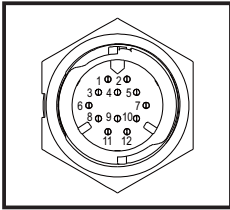

Mating connector CD-12BFFA-QL8AP0 or equivalent







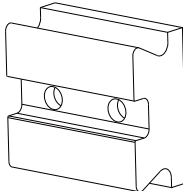

Alarm and signal

Pin No.	Function	Description
1	DC-OK-GND	Dry contact output. Open: alarm, Closed: normal.
2	Remote ON-OFF	The unit can turn the output OFF by dry contact between OFF and GND-AUX.(Note) Short (10.8 ~ 13.2V) : Power ON ; Open(0 ~ 0.5V) : Power OFF ; The maximum input voltage is 13.2V
3	DC-OK	Dry contact output. Open: alarm, Closed: normal. Relay contact rating(maximum) is 30V/1A resistive.
4	+12V-AUX	Auxiliary voltage output, 10.8~13.2V, referenced to GND-AUX (pin9 & 10). The maximum load current is 0.5A. This output is not controlled by "Remote ON-OFF".
5,7	GND-AUX	Auxiliary voltage output GND. The signal return is isolated from the output terminals (+V & -V).
6	AC Fail-GND	Dry contact output, Open: alarm; Closed: normal.
8	AC Fail	Dry contact output, Open: alarm; Closed: normal. Relay contact rating(maximum) is 30V/1A resistive.
9	T-Alarm-GND	Dry contact output, Open: normal; Closed: alarm. (OTP signal)
10	SDA	For PMBus model: Serial Data used in the PMBus interface. (Note)
	CANH	For CANBus model: Data line used in CANBus interface. (Note)
	Data +	For RS-485 model: Data +.
11	T-Alarm	Dry contact output, Open: normal; Closed: alarm. (OTP signal) Relay contact rating(maximum) is 30V/1A resistive.
12	SCL	For PMBus model: Serial Clock used in the PMBus interface. (Note)
	CANL	For CANBus model: Data line used in CANBus interface. (Note)
	Data -	For RS-485 model: Data -.

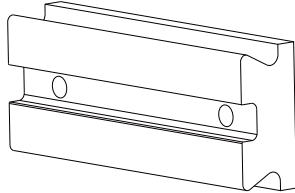
Note: Isolated signal, referenced to GND-AUX.

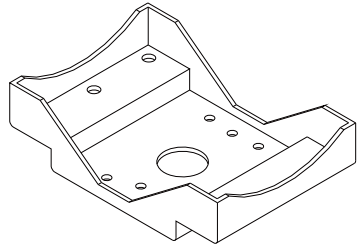
■ Accessory List

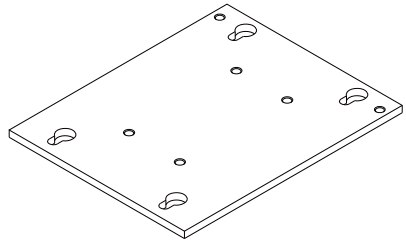
※ Optional equipment

MW's Order No.		Item	Quantity
D**1293A-FA (For housing side)	①	  M6 L=16*2	1
D**1293A-FB (For pole side)	②	  M6 L=16*2	1
D**1293A-FC	③	  M6 L=12*4	2
D**1293A-FD	④	  M6 L=25*4	1

■ Mounting Methods

1. Normal Mounted (Standard type)

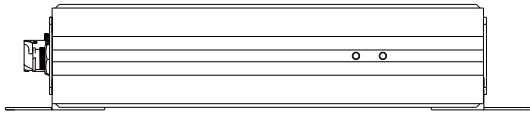

Horizontal mounted

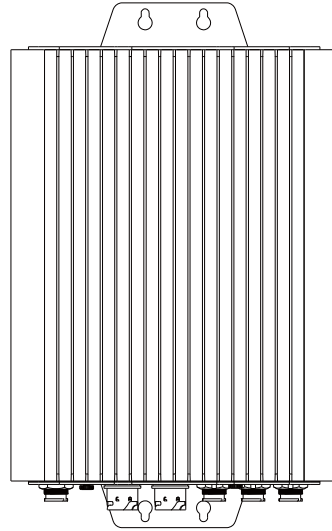

Vertical mounted

2. Pole mounted with a bracket kit (Optional type)

◎ Rear mounted (Optional Bracket Part No: D**1293A-FC、D**1293A-FD)

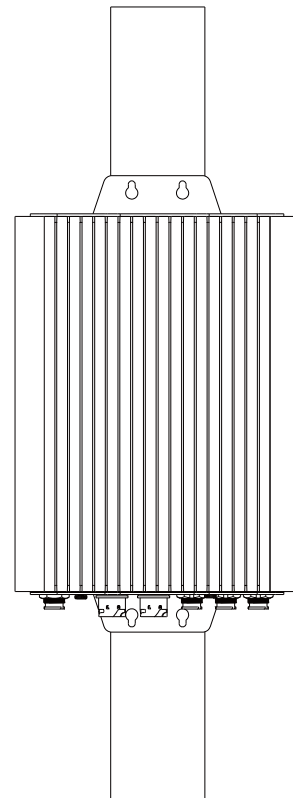
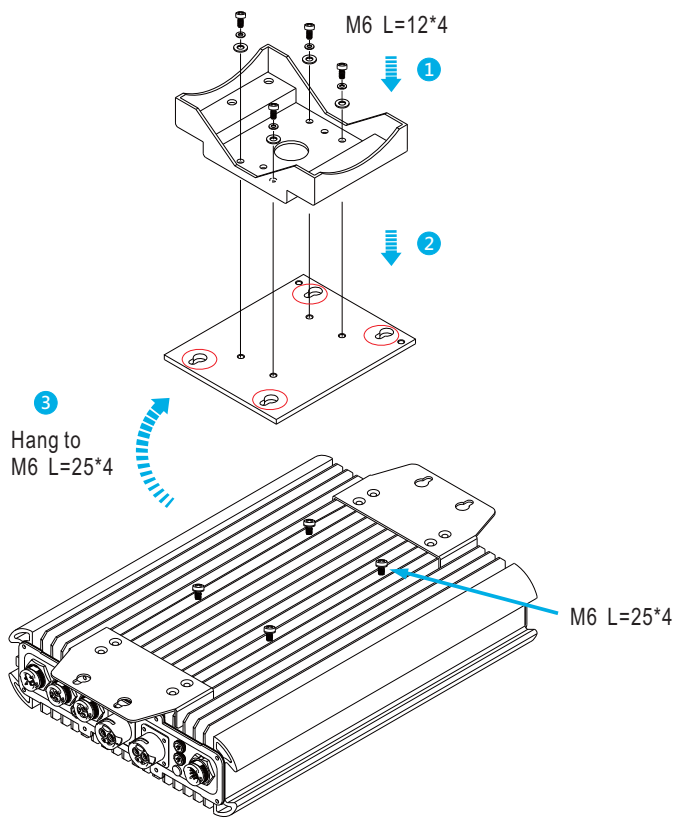

© Side mounted (Optional Bracket part No.: D**1293A-FA、D**1293A-FB、D**1293A-FC)

