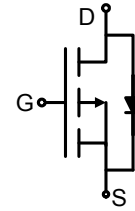


## P-Channel Enhancement Mode Power MOSFET

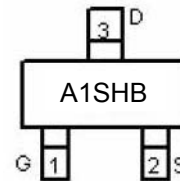
# 2301

### General Features

- $V_{DS} = -20V, I_D = -2.5A$   
 $R_{DS(ON)} < 160m\Omega @ V_{GS} = -2.5V$   
 $R_{DS(ON)} < 120m\Omega @ V_{GS} = -4.5V$
- High power and current handling capability
- Lead free product is acquired
- Surface mount package



Schematic diagram



Marking and pin assignment



SOT-23 top view

### Application

- PWM applications
- Load switch

### Package Marking and Ordering Information

Device Marking	Device	Device Package	Reel Size	Tape width	Quantity
A12SHB	HM2301B	SOT-23	Ø180mm	8 mm	3000 units

### Absolute Maximum Ratings ( $T_A = 25^\circ C$ unless otherwise noted)

Parameter	Symbol	Limit	Unit
Drain-Source Voltage	$V_{DS}$	-20	V
Gate-Source Voltage	$V_{GS}$	$\pm 12$	V
Drain Current-Continuous	$I_D$	-2.5	A
Drain Current -Pulsed <sup>(Note 1)</sup>	$I_{DM}$	-10	A
Maximum Power Dissipation	$P_D$	0.9	W
Operating Junction and Storage Temperature Range	$T_J, T_{STG}$	-55 To 150	$^\circ C$

### Thermal Characteristic

Thermal Resistance, Junction-to-Ambient <sup>(Note 2)</sup>	$R_{\theta JA}$	138	$^\circ C/W$
---	-----------------	-----	--------------

### Electrical Characteristics ( $T_A = 25^\circ C$ unless otherwise noted)

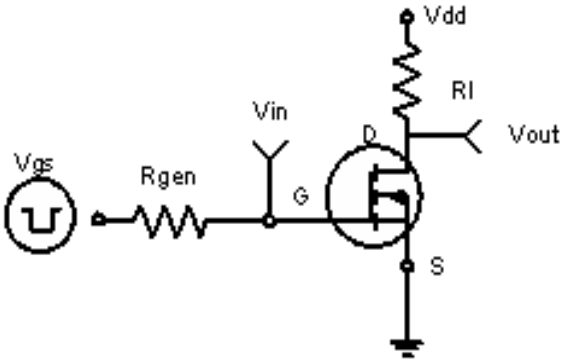
Parameter	Symbol	Condition	Min	Typ	Max	Unit
<b>Off Characteristics</b>						
Drain-Source Breakdown Voltage	$BV_{DSS}$	$V_{GS} = 0V, I_D = -250\mu A$	-20		-	V
Zero Gate Voltage Drain Current	$I_{DSS}$	$V_{DS} = -20V, V_{GS} = 0V$	-	-	-1	$\mu A$

Parameter	Symbol	Condition	Min	Typ	Max	Unit
Gate-Body Leakage Current	$I_{GSS}$	$V_{GS}=\pm 12V, V_{DS}=0V$	-	-	$\pm 100$	nA
<b>On Characteristics</b> <sup>(Note 3)</sup>						
Gate Threshold Voltage	$V_{GS(th)}$	$V_{DS}=V_{GS}, I_D=-250\mu A$	-0.4	-0.7	-1	V
Drain-Source On-State Resistance	$R_{DS(ON)}$	$V_{GS}=-4.5V, I_D=-2A$	-	78	120	m $\Omega$
		$V_{GS}=-2.5V, I_D=-1.8A$	-	102	160	m $\Omega$
Forward Transconductance	$g_{FS}$	$V_{DS}=-5V, I_D=-1A$	6	-	-	S
<b>Dynamic Characteristics</b> <sup>(Note 4)</sup>						
Input Capacitance	$C_{ISS}$	$V_{DS}=-10V, V_{GS}=0V,$ $F=1.0MHz$	-	325	-	PF
Output Capacitance	$C_{OSS}$		-	63	-	PF
Reverse Transfer Capacitance	$C_{RSS}$		-	37	-	PF
<b>Switching Characteristics</b> <sup>(Note 4)</sup>						
Turn-on Delay Time	$t_{d(on)}$	$V_{DD}=-10V, R_L=5\Omega$ $V_{GS}=-4.5V, R_{GEN}=3\Omega$	-	11	-	nS
Turn-on Rise Time	$t_r$		-	5.5	-	nS
Turn-Off Delay Time	$t_{d(off)}$		-	22	-	nS
Turn-Off Fall Time	$t_f$		-	8	-	nS
Total Gate Charge	$Q_g$	$V_{DS}=-10V, I_D=-2A,$ $V_{GS}=-4.5V$	-	3.2	-	nC
Gate-Source Charge	$Q_{gs}$		-	0.6	-	nC
Gate-Drain Charge	$Q_{gd}$		-	0.9	-	nC
<b>Drain-Source Diode Characteristics</b>						
Diode Forward Voltage <sup>(Note 3)</sup>	$V_{SD}$	$V_{GS}=0V, I_S=2A$	-	-	-1.2	V
Diode Forward Current <sup>(Note 2)</sup>	$I_S$		-	-	-2.5	A

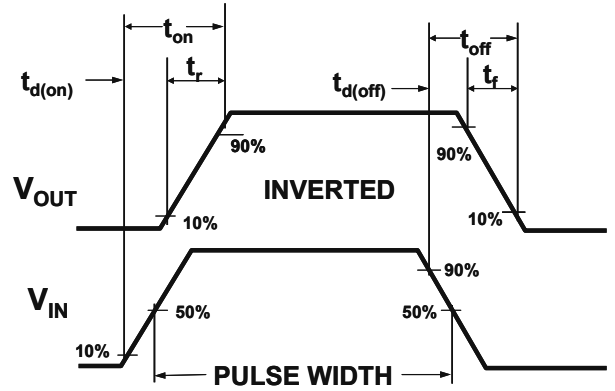
### Notes:

1. Repetitive Rating: Pulse width limited by maximum junction temperature.
2. Surface Mounted on FR4 Board,  $t \leq 10$  sec.
3. Pulse Test: Pulse Width  $\leq 300\mu s$ , Duty Cycle  $\leq 2\%$ .
4. Guaranteed by design, not subject to production

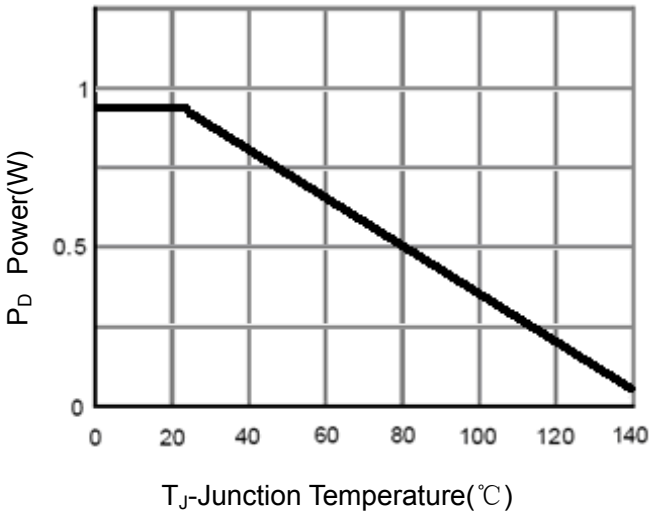
## Typical Electrical and Thermal Characteristics



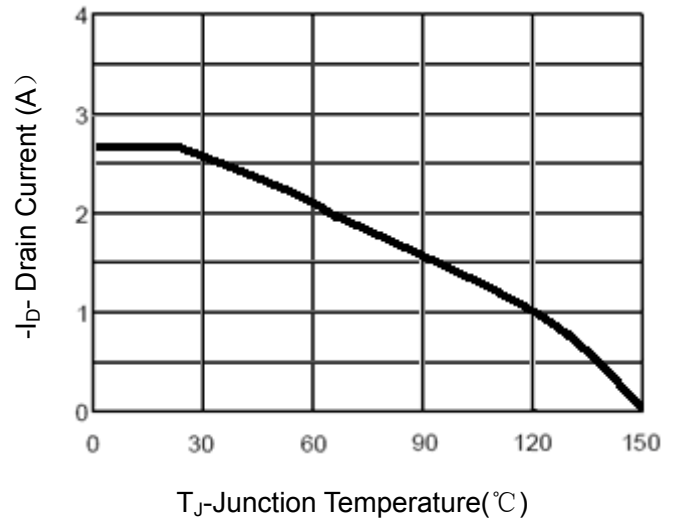
**Figure 1: Switching Test Circuit**



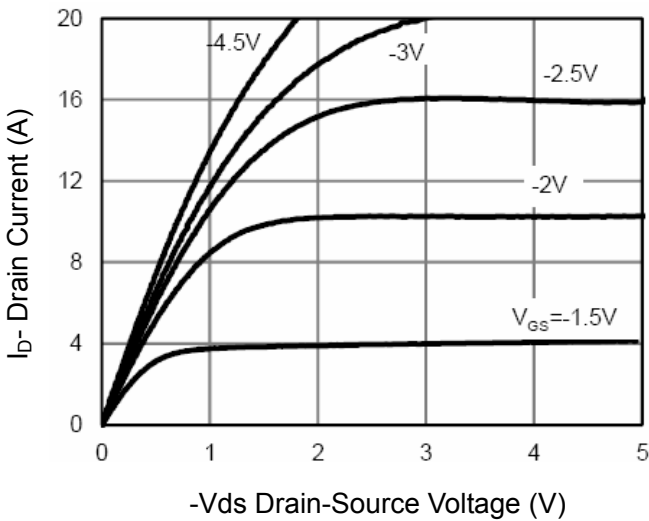
**Figure 2: Switching Waveforms**



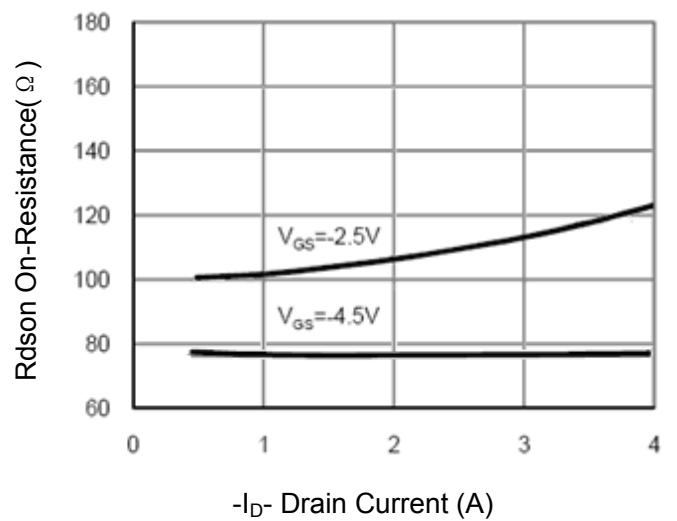
**Figure 3 Power Dissipation**



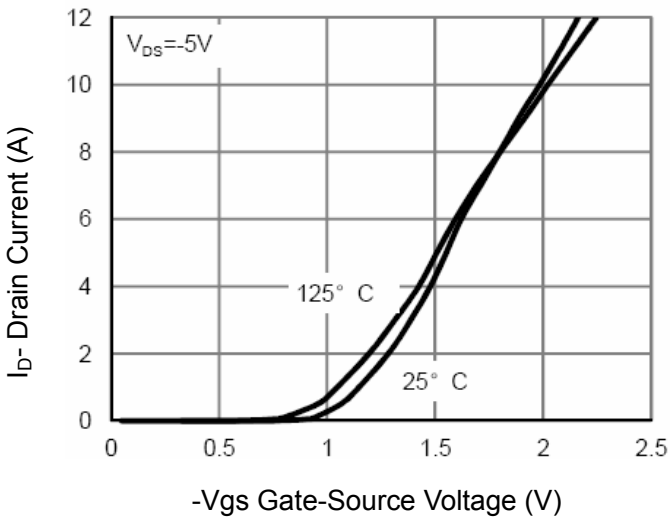
**Figure 4 Drain Current**



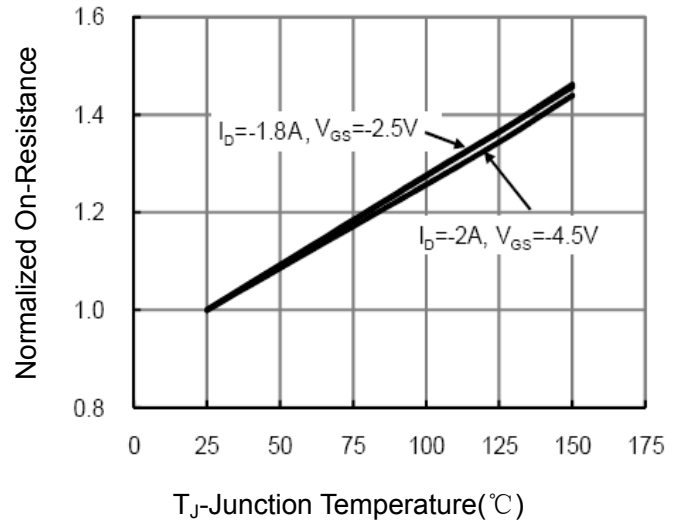
**Figure 5 Output Characteristics**



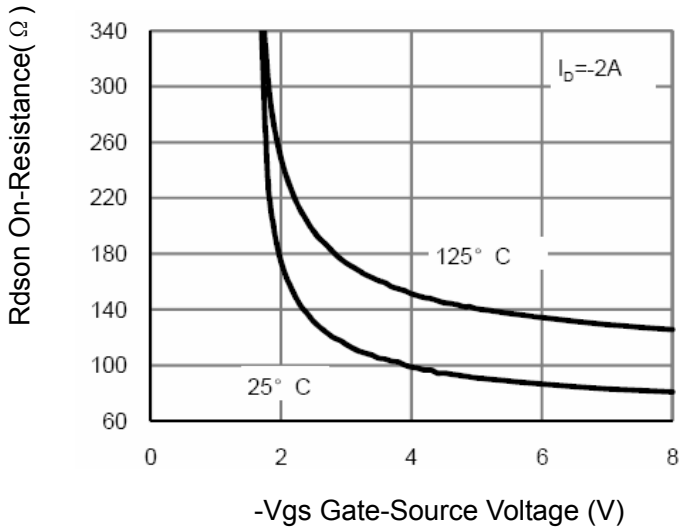
**Figure 6 Drain-Source On-Resistance**



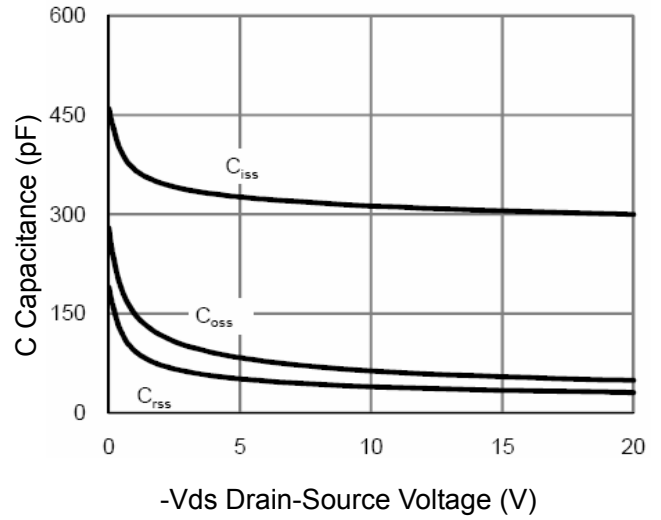
**Figure 7 Transfer Characteristics**



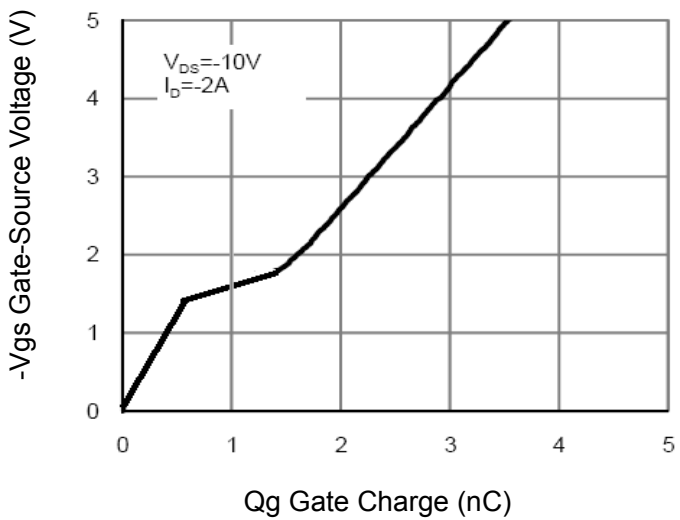
**Figure 8 Drain-Source On-Resistance**



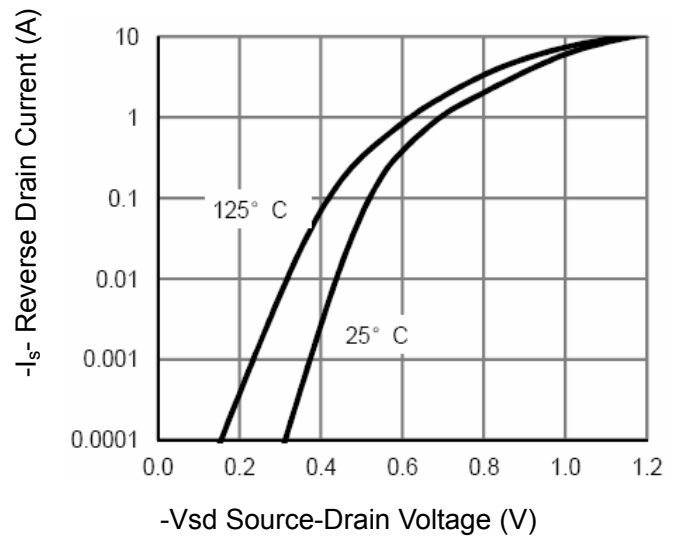
**Figure 9 Rdson vs Vgs**



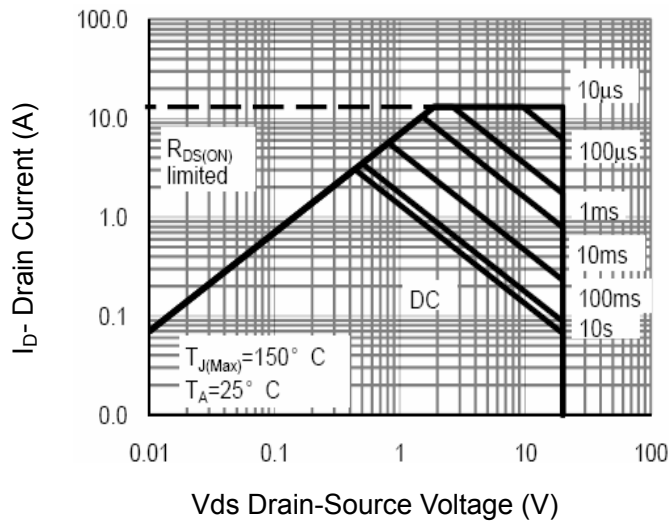
**Figure 10 Capacitance vs Vds**



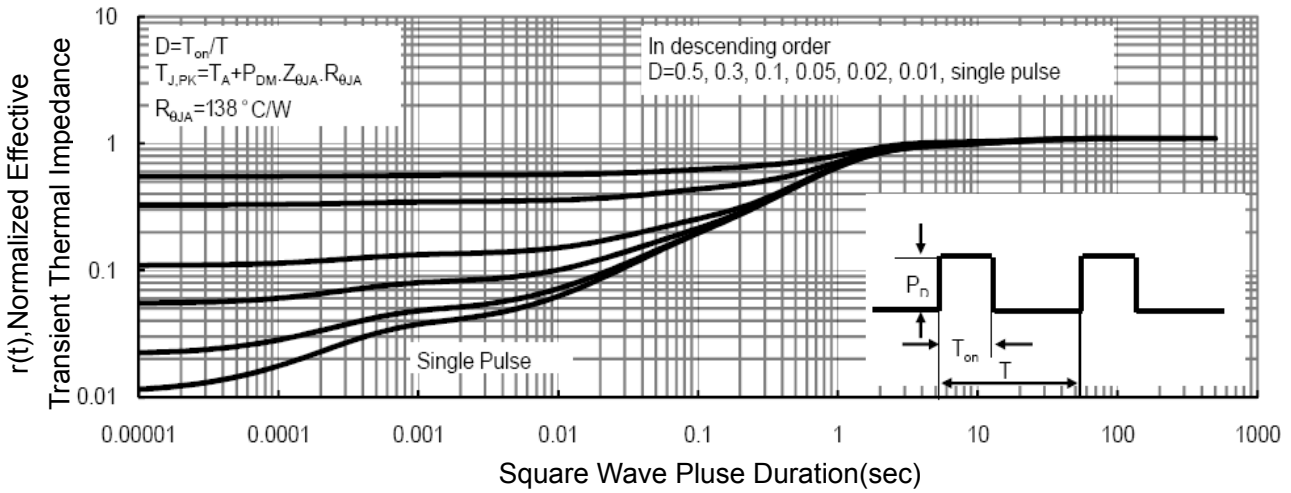
**Figure 11 Gate Charge**



**Figure 12 Source- Drain Diode Forward**

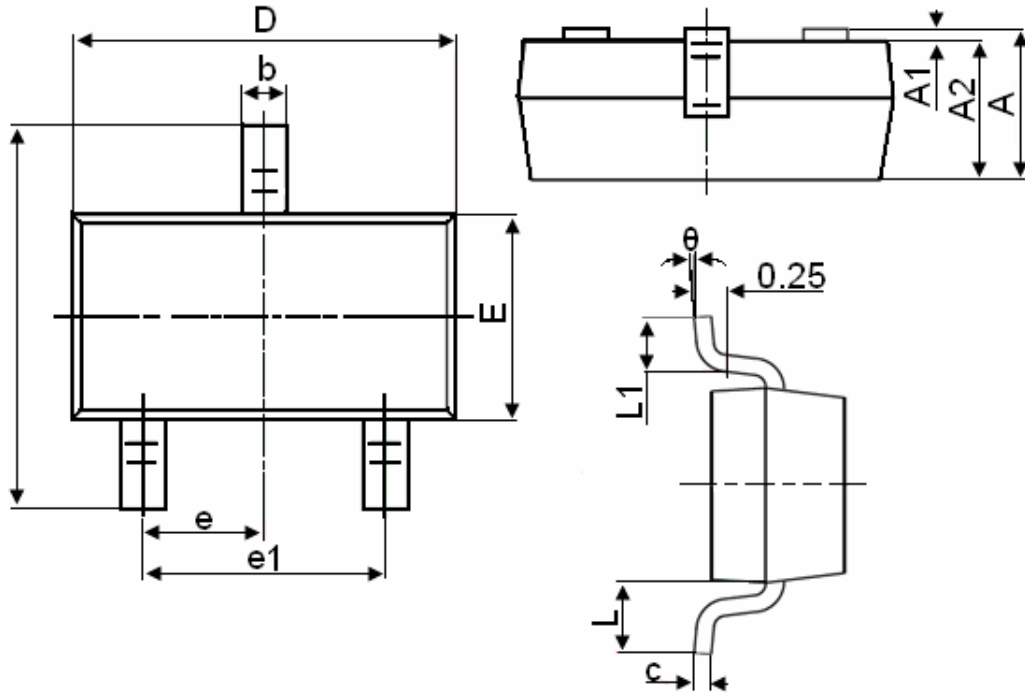


**Figure 13 Safe Operation Area**



**Figure 14 Normalized Maximum Transient Thermal Impedance**

### SOT-23 Package Information



Symbol	Dimensions in Millimeters	
	MIN.	MAX.
A	0.900	1.150
A1	0.000	0.100
A2	0.900	1.050
b	0.300	0.500
c	0.080	0.150
D	2.800	3.000
E	1.200	1.400
E1	2.250	2.550
e	0.950TYP	
e1	1.800	2.000
L	0.550REF	
L1	0.300	0.500
$\theta$	0°	8°

### Notes

1. All dimensions are in millimeters.
2. Tolerance  $\pm 0.10$ mm (4 mil) unless otherwise specified
3. Package body sizes exclude mold flash and gate burrs. Mold flash at the non-lead sides should be less than 5 mils.
4. Dimension L is measured in gauge plane.
5. Controlling dimension is millimeter, converted inch dimensions are not necessarily exact.