

2321 P-Channel 20-V(D-S) MOSFET

$V_{(BR)DSS}$	$R_{DS(on)MAX}$	I_D
-20V	57mΩ@-4.5V	-2.9A
	76mΩ@-2.5V	
	110mΩ@-1.8V	

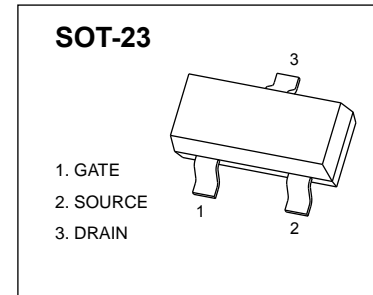

FEATURE

- TrenchFET Power MOSFET

APPLICATION

- PA Switch
- Load Switch

MARKING

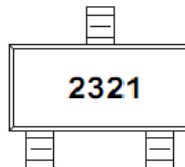
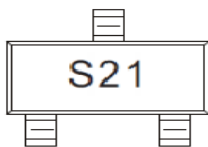

Equivalent Circuit

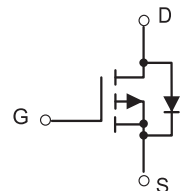

Maximum ratings ($T_a=25^{\circ}C$ unless otherwise noted)

Parameter	Symbol	Value	Unit
Drain-Source Voltage	V_{DS}	-20	V
Gate-Source Voltage	V_{GS}	±12	
Continuous Drain Current	I_D	-2.9	A
Pulsed Drain Current	I_{DM}	-12	
Continuous Source-Drain Diode Current	I_S	-0.59	
Maximum Power Dissipation	P_D	0.35	W
Thermal Resistance from Junction to Ambient	$R_{\theta JA}$	357	$^{\circ}C/W$
Operation Junction and Storage Temperature Range	T_J, T_{stg}	-50 ~ +150	$^{\circ}C$

$T_a=25\text{ }^\circ\text{C}$ unless otherwise specified

Parameter	Symbol	Test Condition	Min	Typ	Max	Unit
Static						
Drain-source breakdown voltage	$V_{(BR)DSS}$	$V_{GS} = 0V, I_D = -10\mu A$	-20			V
Gate-source leakage	I_{GSS}	$V_{DS} = 0V, V_{GS} = \pm 12V$			± 100	nA
Zero Gate voltage drain current	I_{DSS}	$V_{DS} = -16V, V_{GS} = 0V$			-1.0	μA
Gate-source threshold voltage	$V_{GS(th)}$	$V_{DS} = V_{GS}, I_D = -250\mu A$	-0.4		-0.9	V
Drain-source on-state resistance	$R_{DS(on)}$	$V_{GS} = -4.5V, I_D = -3.3A$		0.035	0.057	Ω
		$V_{GS} = -2.5V, I_D = -2.8A$		0.048	0.076	
		$V_{GS} = -1.8V, I_D = -2.3A$		0.065	0.110	
Forward transconductance	g_{fs}	$V_{DS} = -5V, I_D = -3.3A$	3			S
Forward diode voltage	V_{SD}	$V_{GS} = 0V, I_S = -1.6A$			-1.2	V
Dynamic						
Input capacitance ^{a,b}	C_{iss}	$V_{DS} = -6V, V_{GS} = 0V, f = 1MHz$		715		μF
Output capacitance ^{a,b}	C_{oss}			170		
Reverse transfer capacitance ^{a,b}	C_{rss}			120		
Total Gate charge ^a	Q_g	$V_{DS} = -6V, V_{GS} = -4.5V, I_D = -3.3A$			13	nc
Gate-Source charge ^a	Q_{gs}			1.2		nc
Gate-Drain charge ^a	Q_{gd}			2.2		nc
Switching^{a,b}						
Turn-on delay Time	$t_{d(on)}$	$V_{GEN} = -4.5V, V_{DD} = -6V,$ $I_D = -1.0A, R_G = 6\Omega, R_L = 6\Omega$			25	ns
Rise time	t_r				55	
Turn-off delay time	$t_{d(off)}$				90	
Fall time	t_f				60	

Notes :

a. Pulse Test : pulse width $\leq 300\mu s$, duty cycle $\leq 2\%$.

b. These parameters have no way to verify.

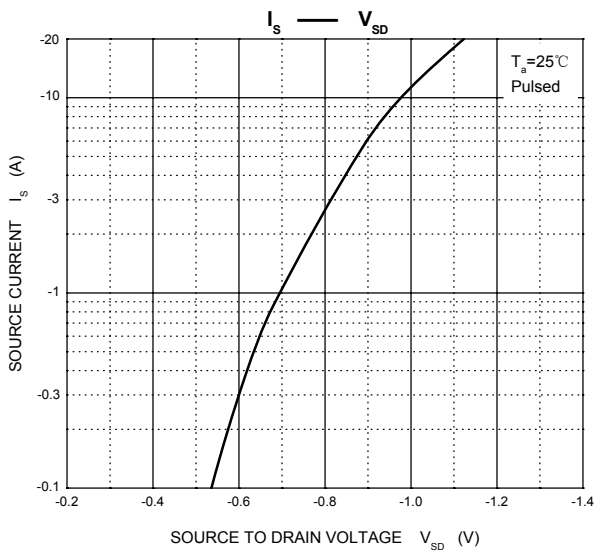
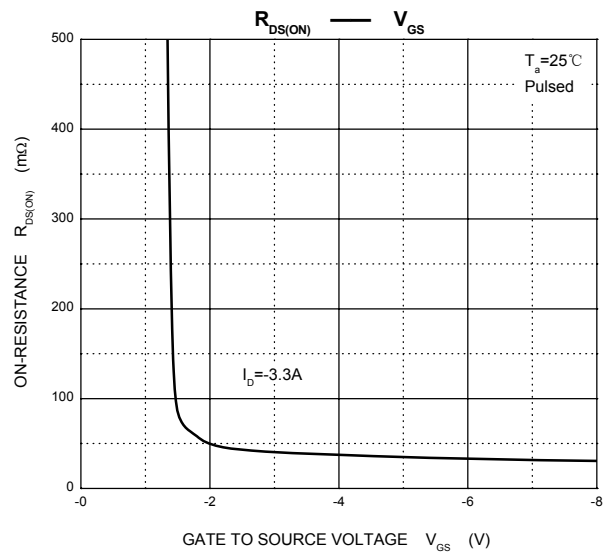
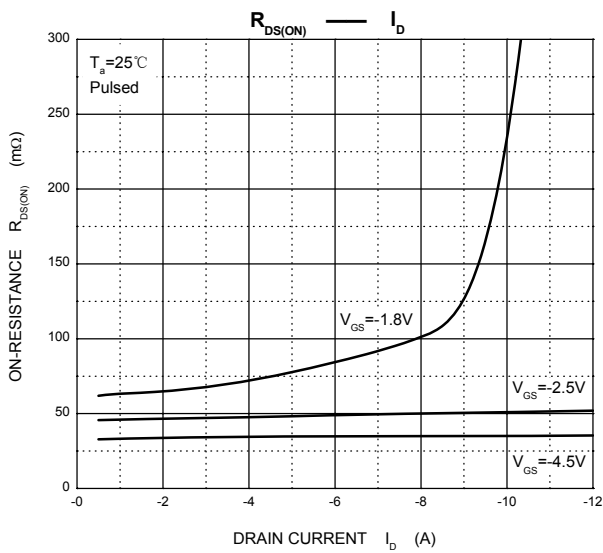
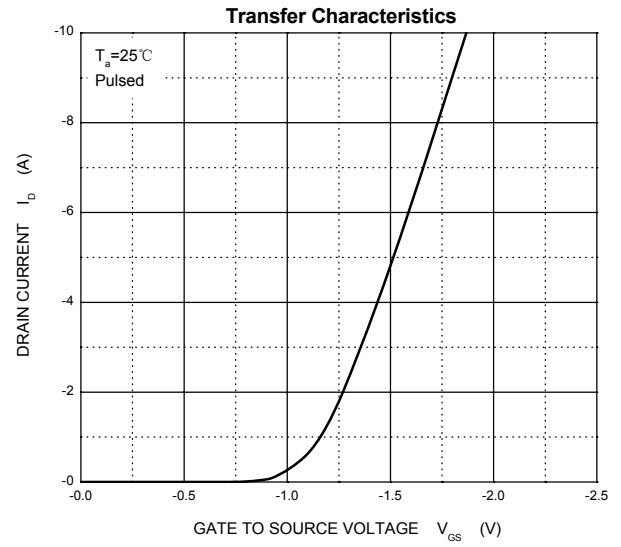
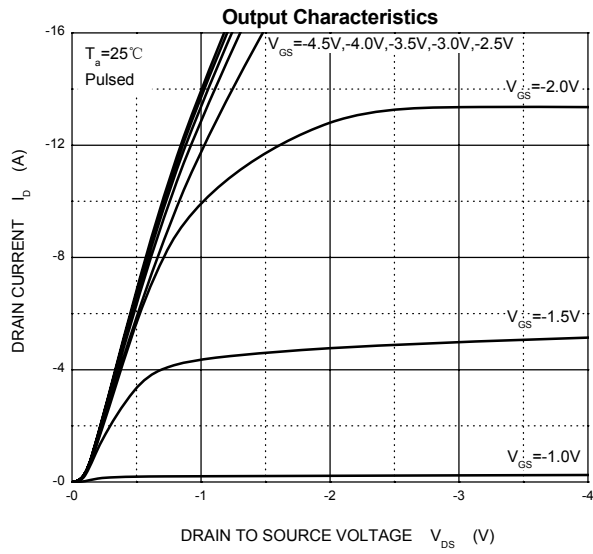



Symbol	Dimensions In Millimeters		Dimensions In Inches	
	Min	Max	Min	Max
A	0.900	1.150	0.035	0.045
A1	0.000	0.100	0.000	0.004
A2	0.900	1.050	0.035	0.041
b	0.300	0.500	0.012	0.020
c	0.080	0.150	0.003	0.006
D	2.800	3.000	0.110	0.118
E	1.200	1.400	0.047	0.055
E1	2.250	2.550	0.089	0.100
e	0.950 TYP		0.037 TYP	
e1	1.800	2.000	0.071	0.079
L	0.550 REF		0.022 REF	
L1	0.300	0.500	0.012	0.020
θ	0°	8°	0°	8°

SOT-23 Suggested Pad Layout

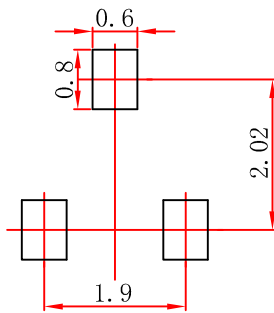

- Note:
1. Controlling dimension: in millimeters.
 2. General tolerance: $\pm 0.05\text{mm}$.
 3. The pad layout is for reference purposes only.

SOT-23 Embossed Carrier Tape

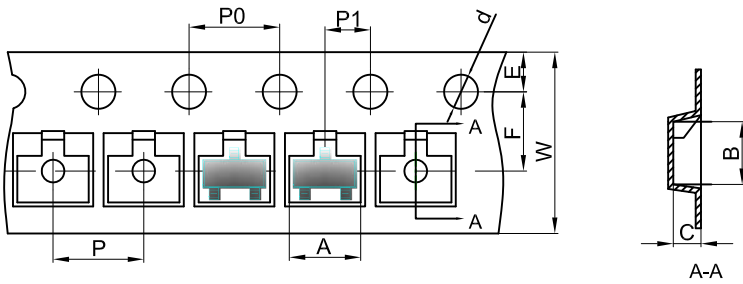

Dimensions are in millimeter										
Pkg type	A	B	C	d	E	F	P0	P	P1	W
SOT-23	3.15	2.77	1.22	Ø1.50	1.75	3.50	4.00	4.00	2.00	8.00

SOT-23 Tape Leader and Trailer

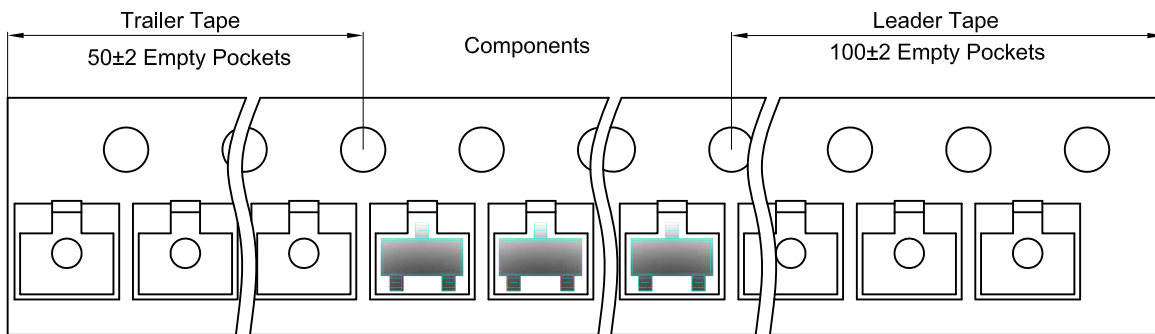

SOT-23 Reel

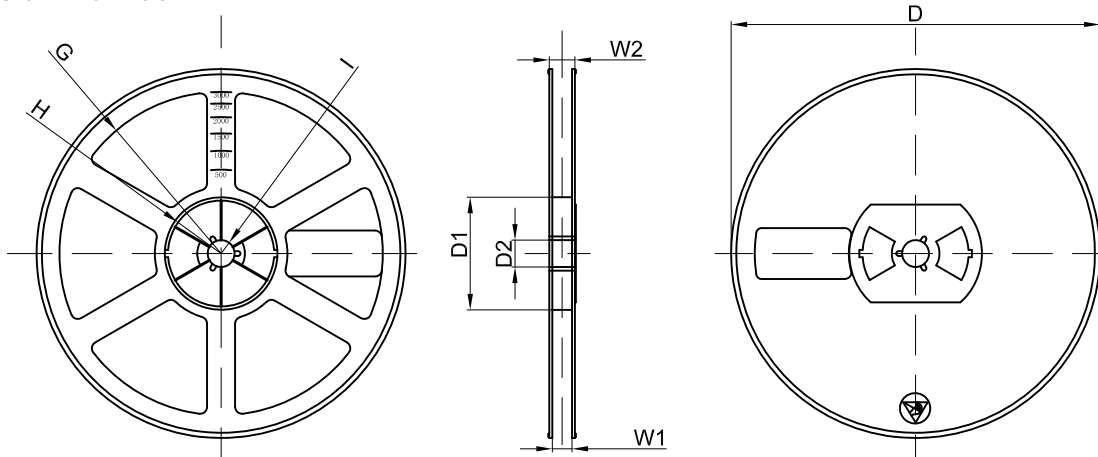

Dimensions are in millimeter								
Reel Option	D	D1	D2	G	H	I	W1	W2
7" Dia	Ø178.00	54.40	13.00	R78.00	R25.60	R6.50	9.50	12.30

REEL	Reel Size	Box
3000 pcs	7 inch	3000 pcs