

2306 N-Channel MOSFET

$V_{(BR)DSS}$	$R_{DS(on)MAX}$	I_D
30V	47mΩ@10V	3.16A
	65mΩ@4.5V	

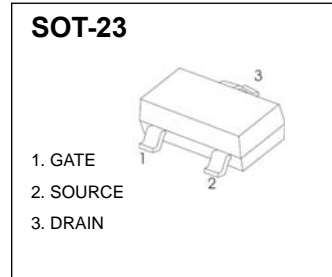

FEATURE

- TrenchFET Power MOSFET

APPLICATION

- Load Switch for Portable Devices
- DC/DC Converter

MARKING



Equivalent Circuit

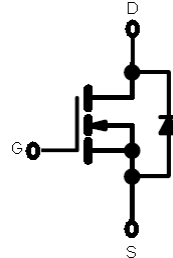

Maximum ratings (at $T_A=25^\circ\text{C}$ unless otherwise noted)

Parameter	Symbol	Value	Unit
Drain-Source voltage	V_{DS}	30	V
Gate-Source Voltage	V_{GS}	±20	
Continuous Drain Current ($T_J=150^\circ\text{C}$) ^{a,b}	I_D	3.16	A
Pulsed Drain Current	I_{DM}	20	
Continuous Source Current(Diode Conduction) ^{a,b}	I_S	0.62	W
Maximum Power Dissipation ^{a,b}	P_D	0.75	
Thermal Resistance from Junction to Ambient ($t \leq 5s$)	$R_{\theta JA}$	100	$^\circ\text{C/W}$
Operating Junction and Storage Temperature Range	T_J, T_{stg}	-55 to 150	$^\circ\text{C}$

Notes :

- Surface Mounted on 1" × 1" FR4 board, $t \leq 5s$.
- Pulse width limited by maximum junction temperature.

$T_a=25\text{ }^\circ\text{C}$ unless otherwise specified

Parameter	Symbol	Test Condition	Min	Typ	Max	Unit
Static						
Drain-Source Breakdown Voltage	$V_{(BR)DS}$	$V_{GS} = 0V, I_D = 250\mu A$	30			V
Gate-Threshold Voltage	$V_{GS(th)}$	$V_{DS} = V_{GS}, I_D = 250\mu A$	1.0		3.0	
Gate-Body Leakage	I_{GSS}	$V_{DS} = 0V, V_{GS} = \pm 20V$			± 100	nA
Zero Gate Voltage Drain Current	I_{DSS}	$V_{DS} = 30V, V_{GS} = 0V$			0.5	μA
Drain-Source On-Resistance ^a	$R_{DS(on)}$	$V_{GS} = 10V, I_D = 3.5A$		0.038	0.047	Ω
		$V_{GS} = 4.5V, I_D = 2.8A$		0.052	0.065	
Forward Transconductance ^a	g_{fs}	$V_{DS} = 4.5V, I_D = 2.5A$		7.0		S
Diode Forward Voltage	V_{SD}	$I_S = 1.25A, V_{GS} = 0V$		0.8	1.2	V
Dynamic						
Gate Charge	Q_g	$V_{DS} = 15V, V_{GS} = 5V, I_D = 2.5A$		3.0	4.5	nC
Total Gate Charge	Q_{gt}	$V_{DS} = 15V, V_{GS} = 10V, I_D = 2.5A$		6	9	
Gate-Source Charge	Q_{gs}			1.6		
Gate-Drain Charge	Q_{gd}			0.6		
Gate Resistance	R_g	$f = 1.0MHz$	2.5	5	7.5	Ω
Input Capacitance	C_{iss}	$V_{DS} = 15V, V_{GS} = 0V, f = 1MHz$		305		pF
Output Capacitance	C_{oss}			65		
Reverse Transfer Capacitance	C_{rss}			29		
Switching						
Turn-On Delay Time	$t_{d(on)}$	$V_{DD} = 15V,$ $R_L = 15\Omega, I_D \approx 1A,$ $V_{GEN} = 10V, R_g = 6\Omega$		7	11	ns
Rise Time	t_r			12	18	
Turn-Off Delay Time	$t_{d(off)}$			14	25	
Fall Time	t_f			6	10	

Notes :

a.Pulse Test : Pulse Width $\leq 300\mu s$, duty cycle $\leq 2\%$.

Output Characteristics

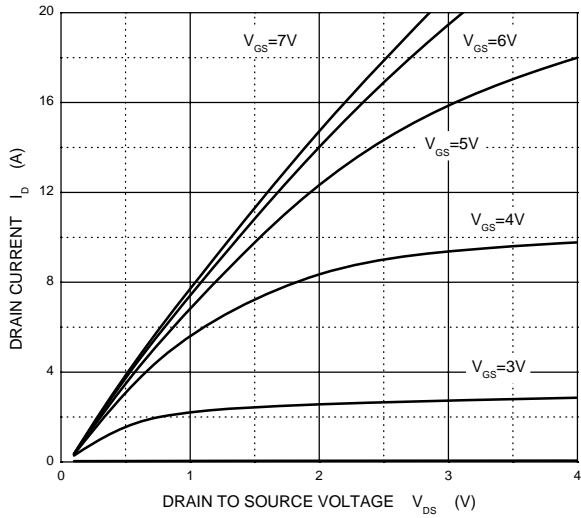

Transfer Characteristics

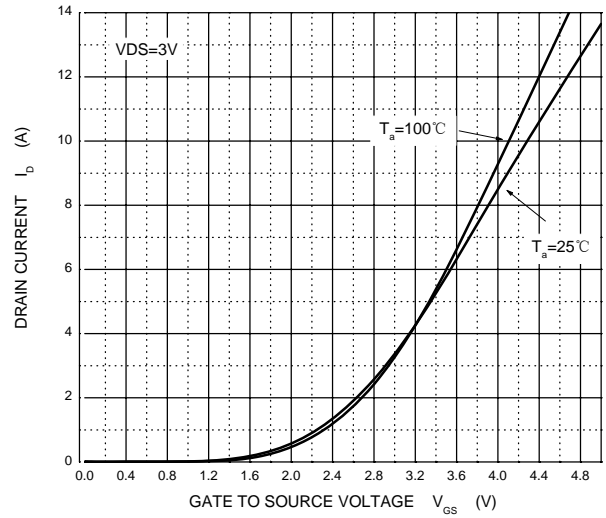

$R_{DS(ON)}$ — I_D

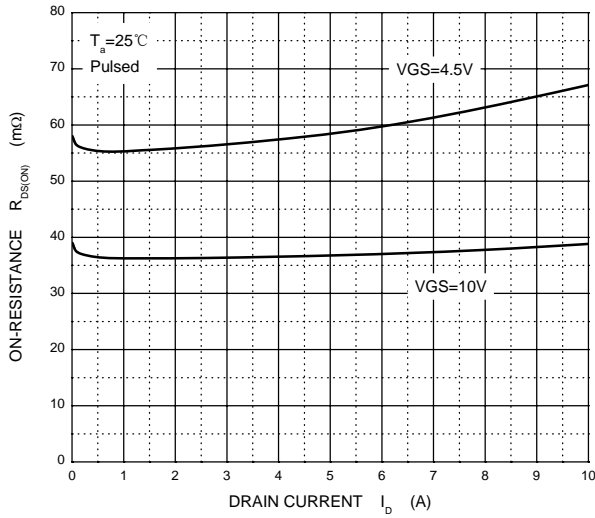

$R_{DS(ON)}$ — V_{GS}

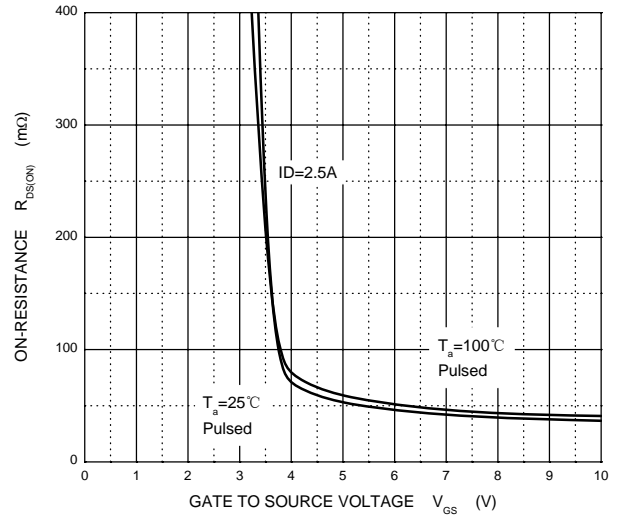

I_S — V_{SD}

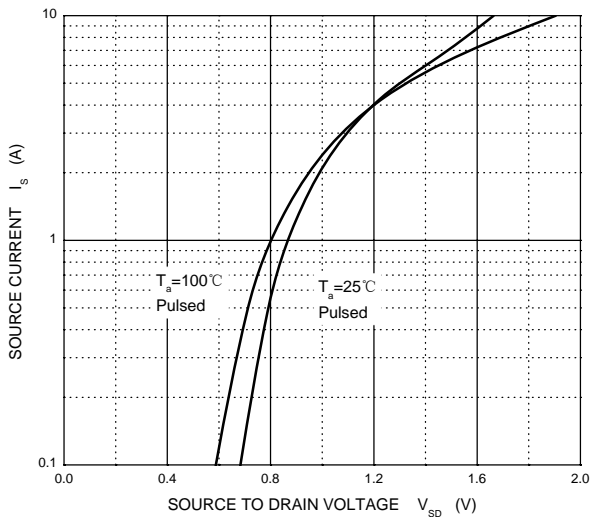

Threshold Voltage

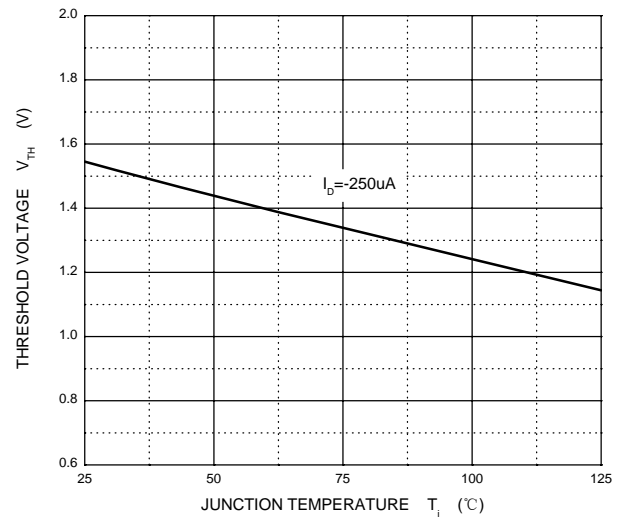



Symbol	Dimensions In Millimeters		Dimensions In Inches	
	Min	Max	Min	Max
A	0.900	1.150	0.035	0.045
A1	0.000	0.100	0.000	0.004
A2	0.900	1.050	0.035	0.041
b	0.300	0.500	0.012	0.020
c	0.080	0.150	0.003	0.006
D	2.800	3.000	0.110	0.118
E	1.200	1.400	0.047	0.055
E1	2.250	2.550	0.089	0.100
e	0.950 TYP		0.037 TYP	
e1	1.800	2.000	0.071	0.079
L	0.550 REF		0.022 REF	
L1	0.300	0.500	0.012	0.020
θ	0°	8°	0°	8°

SOT-23 Suggested Pad Layout

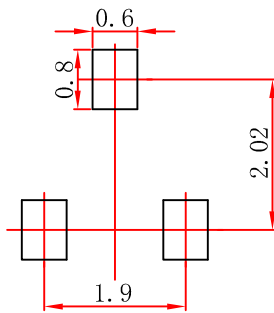

- Note:
1. Controlling dimension: in millimeters.
 2. General tolerance: $\pm 0.05\text{mm}$.
 3. The pad layout is for reference purposes only.

SOT-23 Embossed Carrier Tape

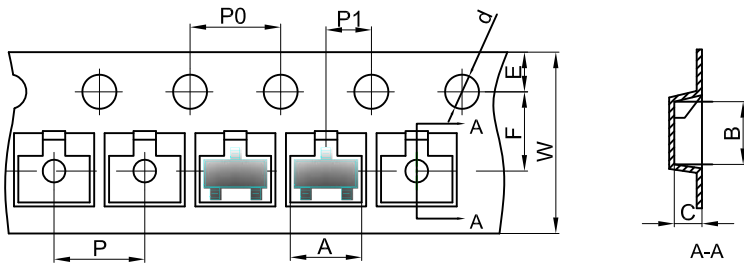

Dimensions are in millimeter										
Pkg type	A	B	C	d	E	F	P0	P	P1	W
SOT-23	3.15	2.77	1.22	Ø1.50	1.75	3.50	4.00	4.00	2.00	8.00

SOT-23 Tape Leader and Trailer

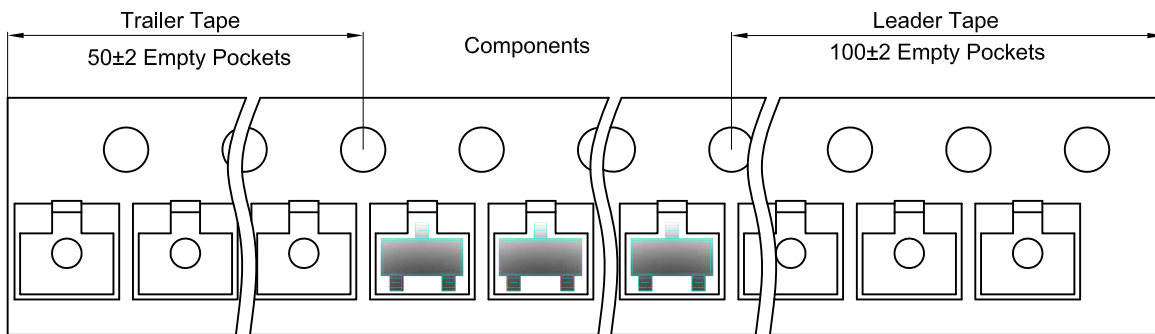

SOT-23 Reel

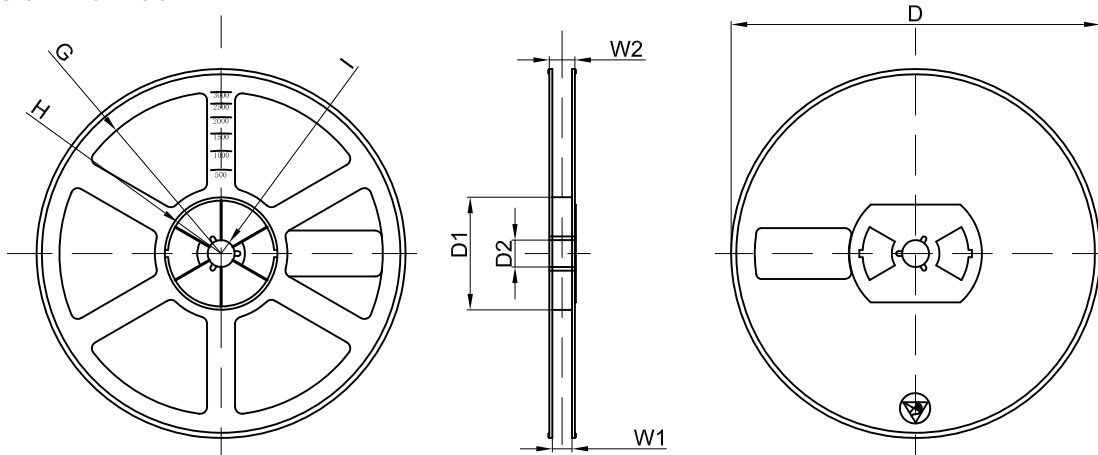

Dimensions are in millimeter								
Reel Option	D	D1	D2	G	H	I	W1	W2
7" Dia	Ø178.00	54.40	13.00	R78.00	R25.60	R6.50	9.50	12.30

REEL	Reel Size	Box
3000 pcs	7 inch	3000 pcs