

2312 N-Channel 20-V(D-S) MOSFET

$V_{(BR)DSS}$	$R_{DS(on)MAX}$	I_D
20V	31.8mΩ@4.5V	5A
	35.6mΩ@2.5V	
	41.4mΩ@1.8V	

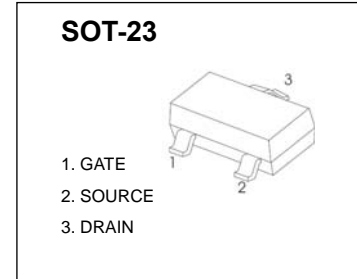

FEATURE

- TrenchFET Power MOSFET

APPLICATION

- DC/DC Converters
- Load Switching for Portable Applications

MARKING

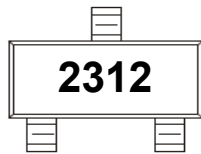
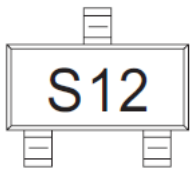

Equivalent Circuit

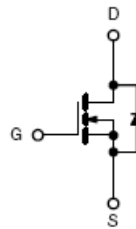

Maximum ratings ($T_a=25^\circ\text{C}$ unless otherwise noted)

Parameter	Symbol	Value	Unit
Drain-Source Voltage	V_{DS}	20	V
Gate-Source Voltage	V_{GS}	± 8.0	
Continuous Drain Current	I_D	5	A
Pulsed Drain Current	I_{DM}	20	
Continuous Source-Drain Diode Current	I_S	1.04	
Maximum Power Dissipation	P_D	0.35	W
Thermal Resistance from Junction to Ambient	$R_{\theta JA}$	357	$^\circ\text{C}/\text{W}$
Operation Junction and Storage Temperature Range	T_J, T_{stg}	-50 ~ +150	$^\circ\text{C}$

$T_a=25\text{ }^\circ\text{C}$ unless otherwise specified

Parameter	Symbol	Test Condition	Min	Typ	Max	Unit
Static						
Drain-source breakdown voltage	$V_{(BR)DSS}$	$V_{GS} = 0V, I_D = 250\mu A$	20			V
Gate-source leakage	I_{GSS}	$V_{DS} = 0V, V_{GS} = \pm 8V$			± 100	nA
Zero gate voltage drain current	I_{DSS}	$V_{DS} = 20V, V_{GS} = 0V$			1.0	μA
Gate-source threshold voltage	$V_{GS(th)}$	$V_{DS} = V_{GS}, I_D = 250\mu A$	0.45	0.7	1.0	V
Drain-source on-state resistance ^a	$R_{DS(on)}$	$V_{GS} = 4.5V, I_D = 5.0A$		0.018	0.0318	Ω
		$V_{GS} = 2.5V, I_D = 4.7A$		0.023	0.0356	
		$V_{GS} = 1.8V, I_D = 4.3A$		0.030	0.0414	
Forward transconductance ^a	g_{fs}	$V_{DS} = 10V, I_D = 5.0A$		6		S
Dynamic^b						
Input capacitance	C_{iss}	$V_{DS} = 10V, V_{GS} = 0V, f = 1MHz$		865		μF
Output capacitance	C_{oss}			105		
Reverse transfer capacitance	C_{rss}			55		
Gate resistance	R_g	$f = 1MHz$	0.5		4.8	Ω
Turn-on delay Time	$t_{d(on)}$	$V_{GEN} = 5V, V_{DD} = 10V,$ $I_D = 4A, R_G = 1\Omega, R_L = 2.2\Omega$			10	ns
Rise time	t_r				20	
Turn-off Delay time	$t_{d(off)}$				32	
Fall time	t_f				12	
Drain-source body diode characteristics						
Forward diode voltage	V_{SD}	$V_{GS} = 0V, I_S = 4A$		0.75	1.2	V

Notes :

- Pulse Test : pulse width $\leq 300\mu s$, duty cycle $\leq 2\%$.
- These parameters have no way to verify.

Output Characteristics

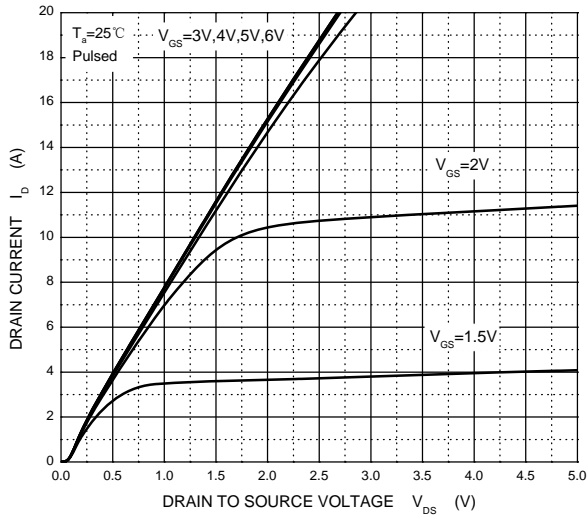

Transfer Characteristics

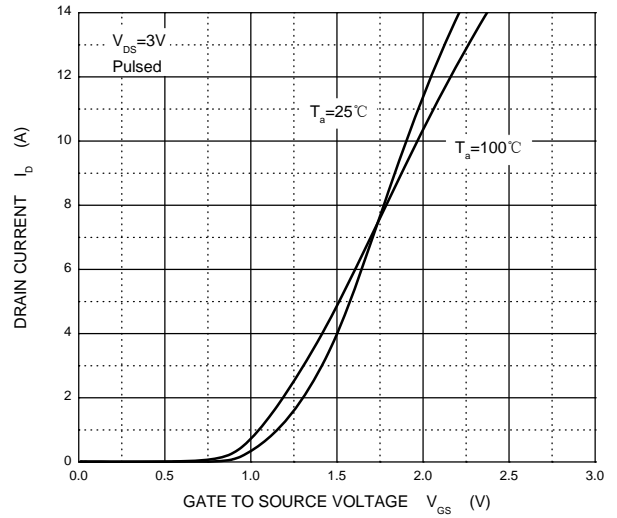

$R_{DS(ON)}$ — I_D

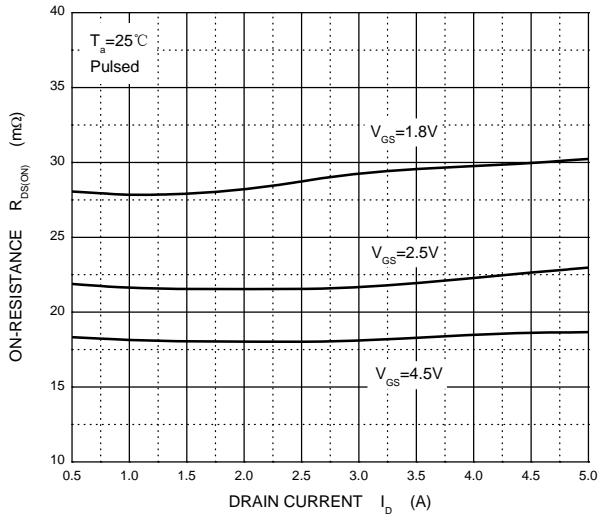

$R_{DS(ON)}$ — V_{GS}

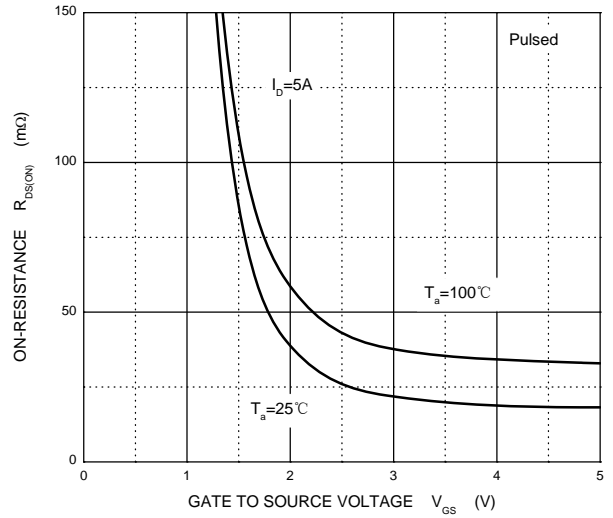

I_S — V_{SD}

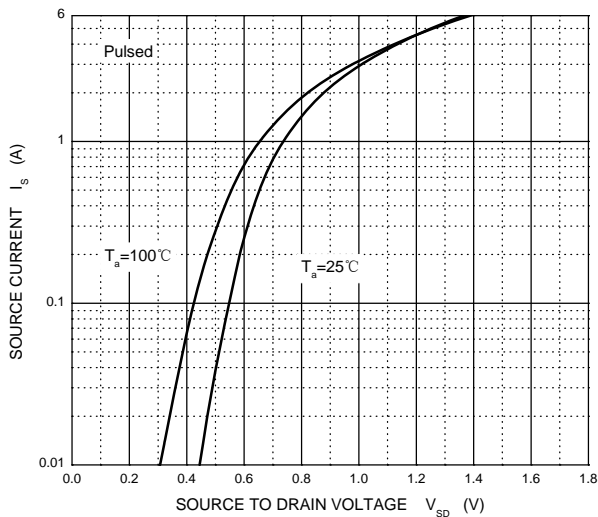

Threshold Voltage

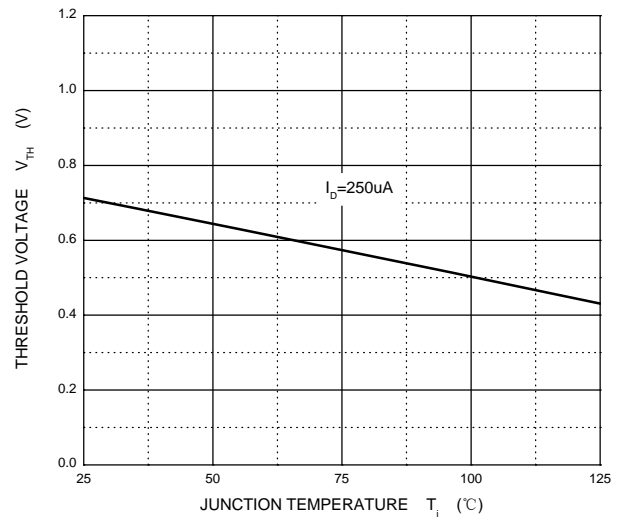



Symbol	Dimensions In Millimeters		Dimensions In Inches	
	Min	Max	Min	Max
A	0.900	1.150	0.035	0.045
A1	0.000	0.100	0.000	0.004
A2	0.900	1.050	0.035	0.041
b	0.300	0.500	0.012	0.020
c	0.080	0.150	0.003	0.006
D	2.800	3.000	0.110	0.118
E	1.200	1.400	0.047	0.055
E1	2.250	2.550	0.089	0.100
e	0.950 TYP		0.037 TYP	
e1	1.800	2.000	0.071	0.079
L	0.550 REF		0.022 REF	
L1	0.300	0.500	0.012	0.020
θ	0°	8°	0°	8°

SOT-23 Suggested Pad Layout



- Note:
1. Controlling dimension: in millimeters.
 2. General tolerance: $\pm 0.05\text{mm}$.
 3. The pad layout is for reference purposes only.

SOT-23 Embossed Carrier Tape

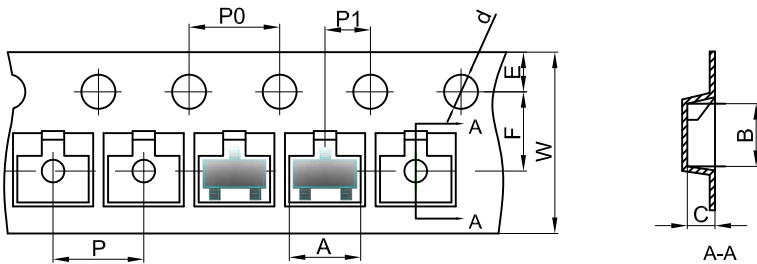

Dimensions are in millimeter										
Pkg type	A	B	C	d	E	F	P0	P	P1	W
SOT-23	3.15	2.77	1.22	Ø1.50	1.75	3.50	4.00	4.00	2.00	8.00

SOT-23 Tape Leader and Trailer

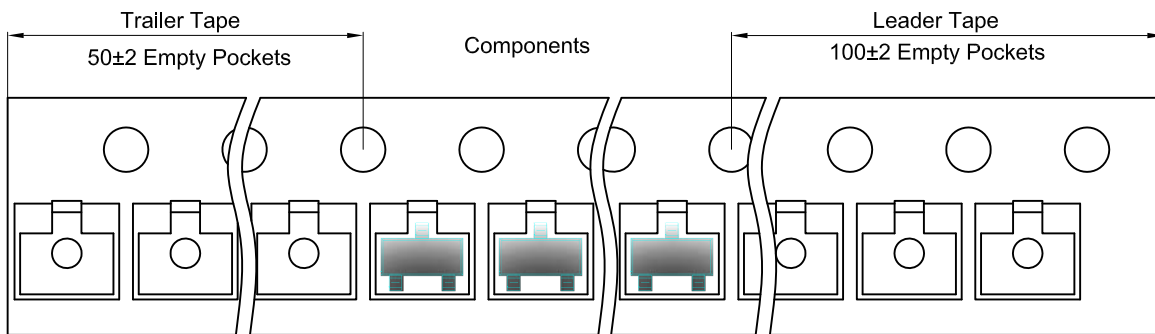

SOT-23 Reel

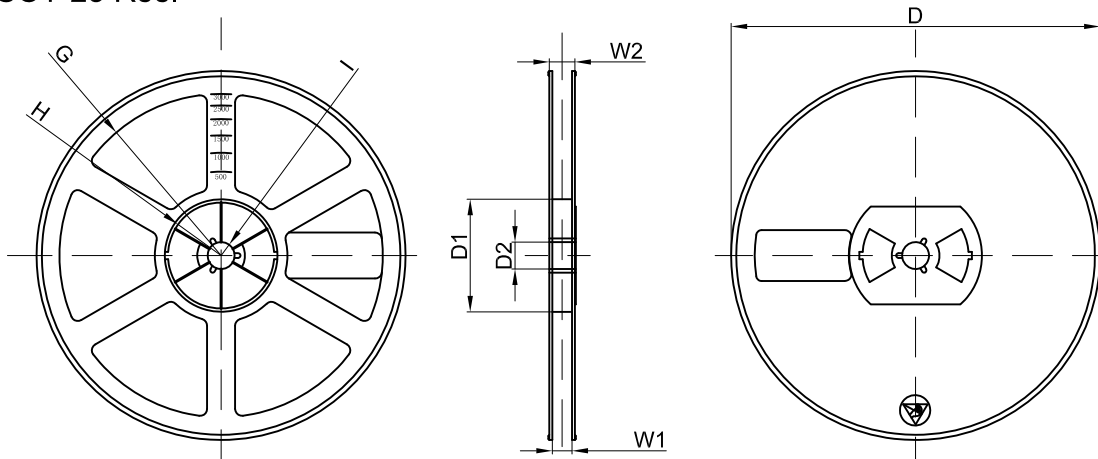

Dimensions are in millimeter								
Reel Option	D	D1	D2	G	H	I	W1	W2
7" Dia	Ø178.00	54.40	13.00	R78.00	R25.60	R6.50	9.50	12.30

REEL	Reel Size	Box
3000 pcs	7 inch	3000 pcs