

**YGMOS Technology Crop.**

20V P-Channel Enhancement-Mode MOSFET    20V P 沟道增强型 MOS 管

**VDS= -20V**
**RDS(ON), Vgs@- 4.5V, Ids@- 4.7A = 45mΩ**
**RDS(ON), Vgs@-2.5V, Ids@-1.0A = 65mΩ**
**Features    特性**

Advanced trench process technology    高级的加工技术

High Density Cell Design For Ultra Low On-Resistance    极低的导通电阻高密度的单元设计

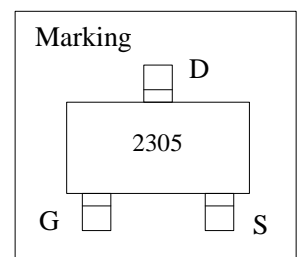
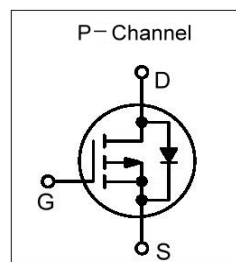
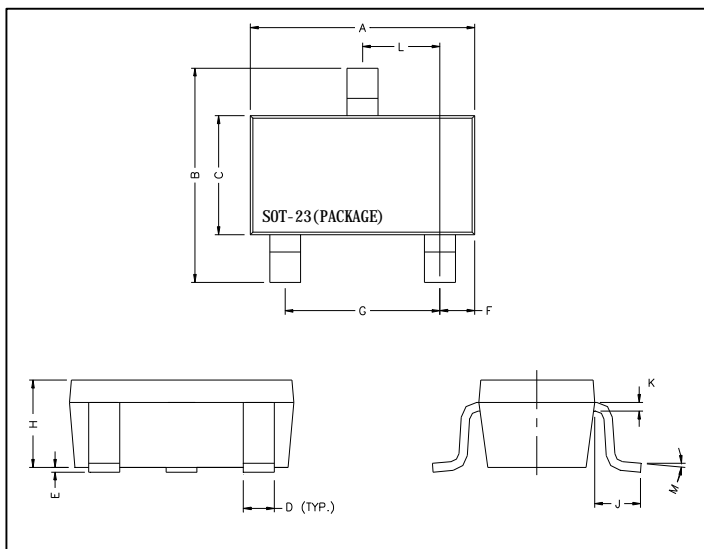
**Package Dimensions    封装尺寸及外形图**

REF.	Millimeter		REF.	Millimeter	
	Min.	Max.		Min.	Max.
A	2.70	3.10	G	1.90	REF.
B	2.40	2.80	H	1.00	1.30
C	1.40	1.60	K	0.10	0.20
D	0.35	0.50	J	0.40	-
E	0	0.10	L	0.85	1.15
F	0.45	0.55	M	0°	10°

**Maximum Ratings and Thermal Characteristics (TA = 25°C unless otherwise noted) 25°C 极限参数和热特性**

Parameter 极限参数	Symbol 符号	Limit 范围	Unit 单位	
Drain-Source Voltage 漏源电压	V <sub>DS</sub>	-20	V	
Gate-Source Voltage 栅源电压	V <sub>GS</sub>	± 12		
Continuous Drain Current 连续漏极电流	I <sub>D</sub>	-5.2	A	
Pulsed Drain Current 脉冲漏极电流	I <sub>DM</sub>	-20		
Maximum Power Dissipation 最大耗散功率	P <sub>D</sub>	TA = 25°C	1.1	W
		TA = 75°C	0.7	
Operating Junction and Storage Temperature Range 使用及储存温度	T <sub>J</sub> , T <sub>stg</sub>	-55 to 150	°C	
Junction-to-Ambient Thermal Resistance (PCB mounted) 结环热阻	R <sub>θJA</sub>	110	°C/W	

**YGMOS Technology Crop.**
**ELECTRICAL CHARACTERISTICS** 一般电气特性

Parameter 参数	符号	Test Condition 测试条件	最小值	典型值	最大值	单位
<b>Static 静态参数</b>						
Drain-Source Breakdown Voltage 漏源击穿电压	$BV_{DSS}$	$V_{GS} = 0V, I_D = 250\mu A$	-20			V
Drain-Source On-State Resistance 漏源导通电阻	$R_{DS(on)}$	$V_{GS} = -4.5V, I_D = -4.7A$		38.0	45.0	mΩ
Drain-Source On-State Resistance 漏源导通电阻	$R_{DS(on)}$	$V_{GS} = -2.7V, I_D = -3.8A$		45.0	60.0	
Drain-Source On-State Resistance 漏源导通电阻	$R_{DS(on)}$	$V_{GS} = -2.5V, I_D = -2.0A$		48.0	65.0	
Gate Threshold Voltage 开启电压	$V_{GS(th)}$	$V_{DS} = V_{GS}, I_D = -250\mu A$	-0.6	-0.85	-1.4	V
Zero Gate Voltage Drain Current 零栅压漏极电流	$I_{DSS}$	$V_{DS} = -20V, V_{GS} = 0V$			-1	μA
Gate Body Leakage 漏极短路时截止栅电流	$I_{GSS}$	$V_{GS} = \pm 12V, V_{DS} = 0V$			±100	nA
Forward Transconductance 正向跨导	$g_{fs}$	$V_{DS} = -10V, I_D = -4.7A$		8.0	—	S
<b>Dynamic 动态参数</b>						
Total Gate Charge 栅极总电荷	$Q_g$	$V_{DS} = -10V, I_D = -4.7A$ $V_{GS} = -4.5V$		24	36	nC
Gate-Source Charge 栅-源极电荷	$Q_{gs}$			18		
Gate-Drain Charge 栅-漏极电荷	$Q_{gd}$			2.7		
Turn-On Delay Time 导通延迟时间	$t_{d(on)}$	$V_{DD} = -10V, R_L = 10\Omega$ $I_D = -1A, V_{GEN} = -4.5V$ $R_G = 6\Omega$		22		ns
Turn-On Rise Time 导通上升时间	$t_r$			35		
Turn-Off Delay Time 关断延迟时间	$t_{d(off)}$			55		
Turn-Off Fall Time 关断下降时间	$t_f$			25		
Input Capacitance 输入电容	$C_{iss}$	$V_{DS} = -6V, V_{GS} = 0V$ $f = 1.0\text{ MHz}$		1024		pF
Output Capacitance 输出电容	$C_{oss}$			220		
Reverse Transfer Capacitance 反向传输电容	$C_{rss}$			87		
<b>Source-Drain Diode 源漏二极管参数</b>						
Max. Diode Forward Current 最大正向电流	$I_S$				-1.7	A
Diode Forward Voltage 正向电压	$V_{SD}$	$I_S = -1.7A, V_{GS} = 0V$			-1.2	V

Note: Pulse test: pulse width ≤ 300us, duty cycle ≤ 2% 注意: 脉冲测试: 脉冲宽度 ≤ 300us 死区 ≤ 2%

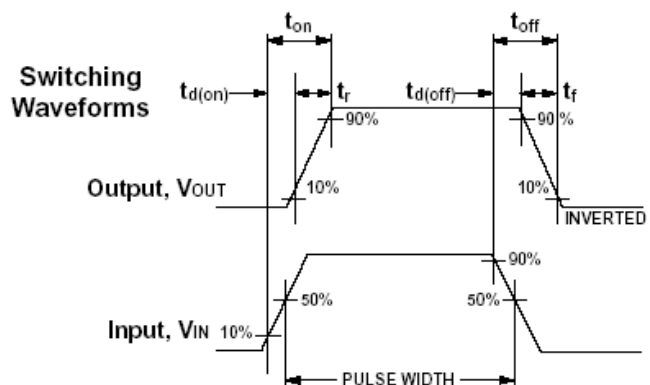
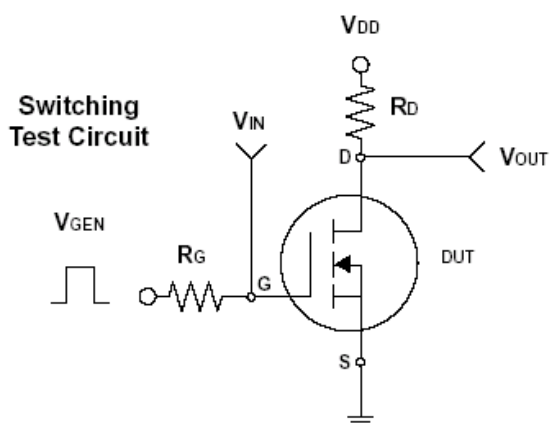

**YGMOS Technology Crop.**
**TYPICAL CHARACTERISTICS** 25 °C, unless otherwise noted

电气性能特征曲线

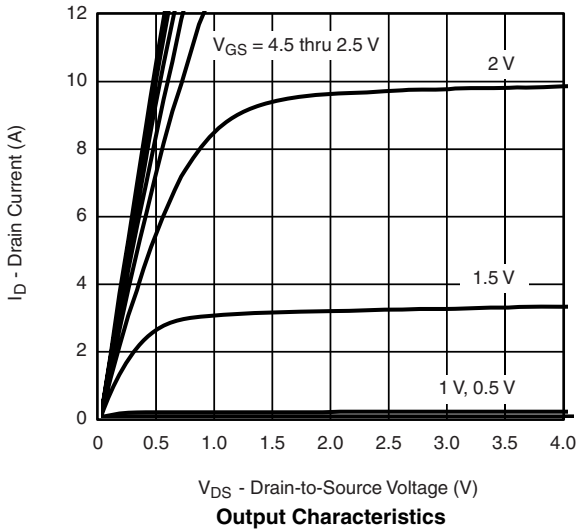
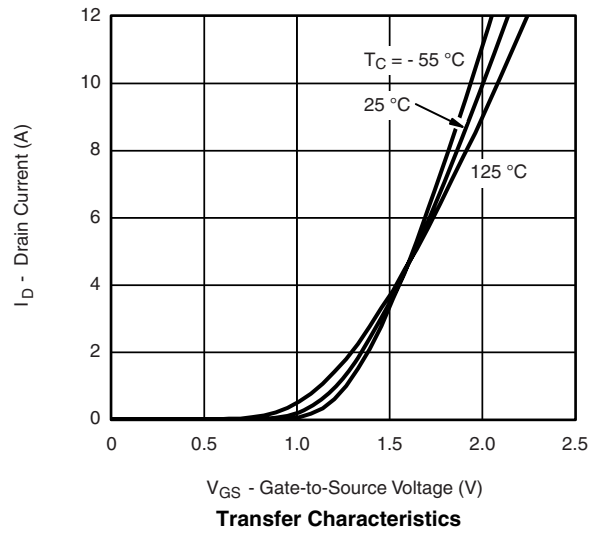
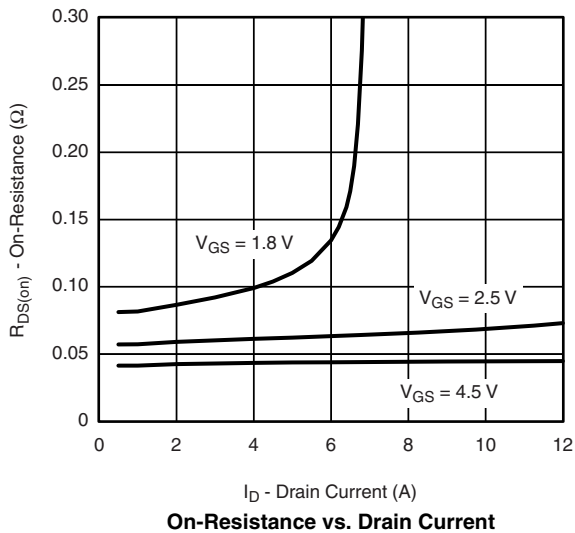
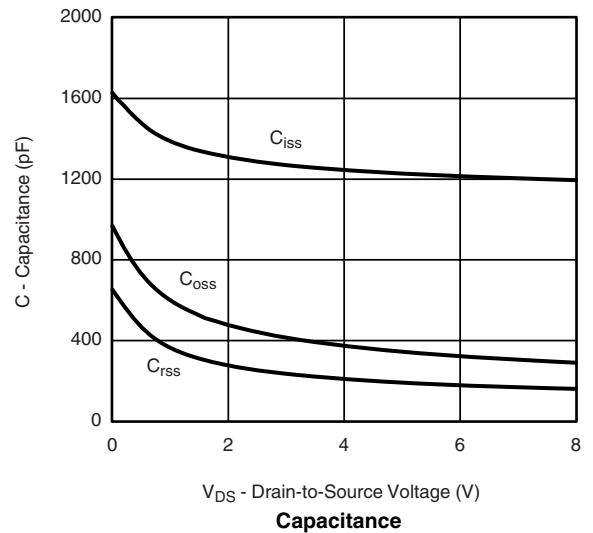
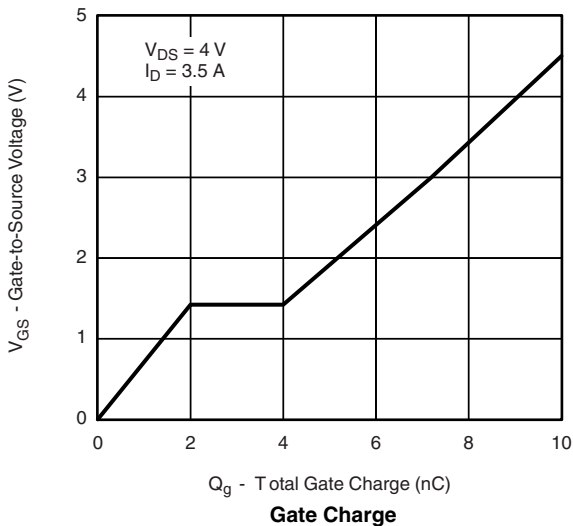
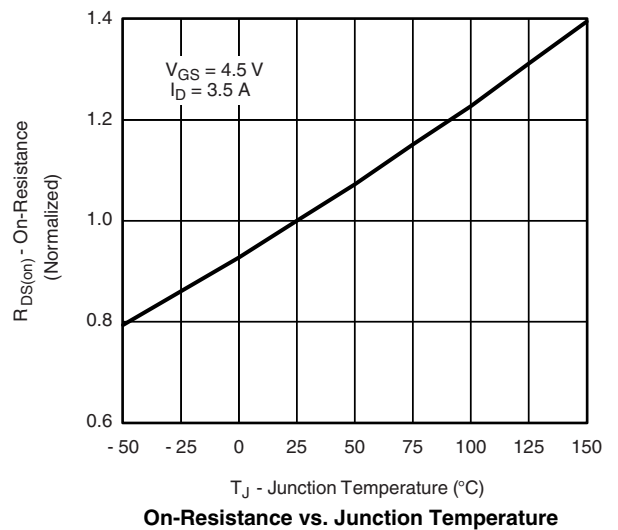
**Output Characteristics**

**Transfer Characteristics**

**On-Resistance vs. Drain Current**

**Capacitance**

**Gate Charge**

**On-Resistance vs. Junction Temperature**