

LL-LLL-CR160

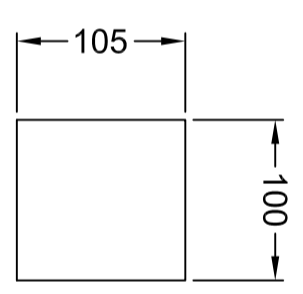

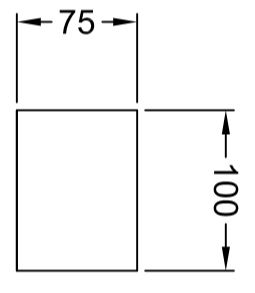

LL-LLL-CR160S  
LL-LLLCR160m

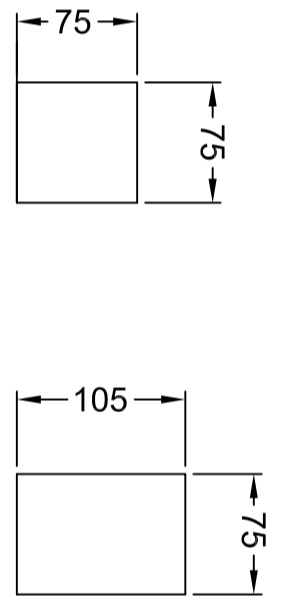

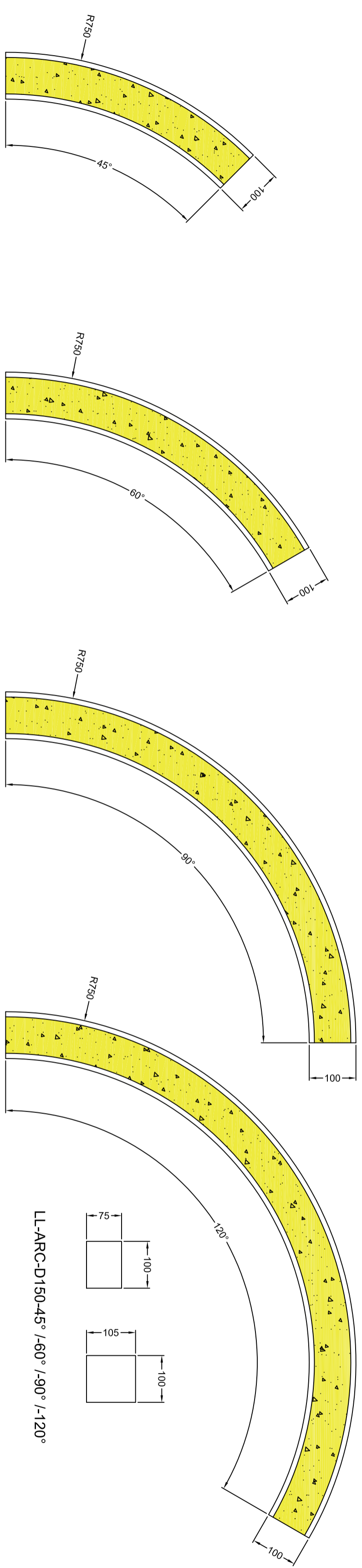

LL-ARC-D150-45° /60° /90° /120°

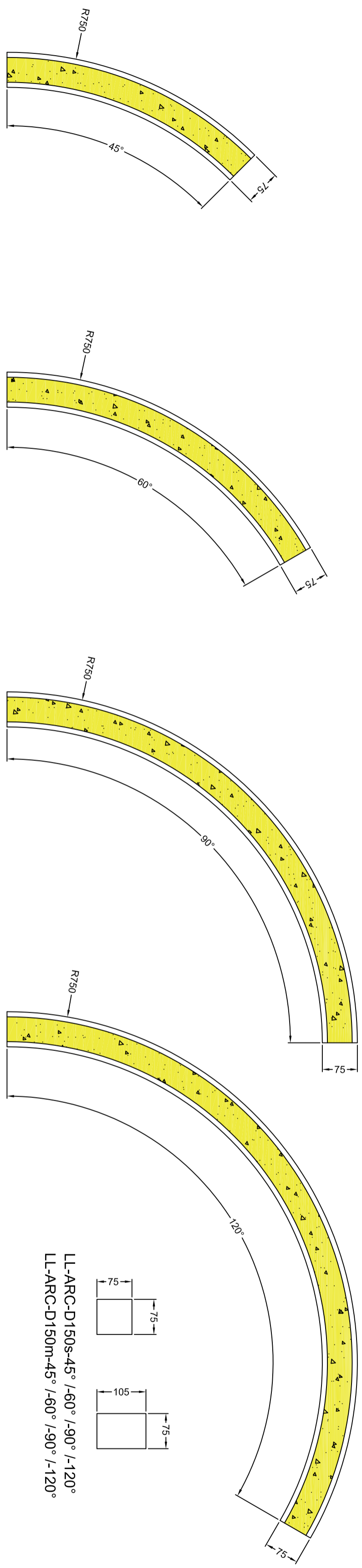

LL-ARC-D150s-45° /60° /90° /120°  
 LL-ARC-D150m-45° /60° /90° /120°

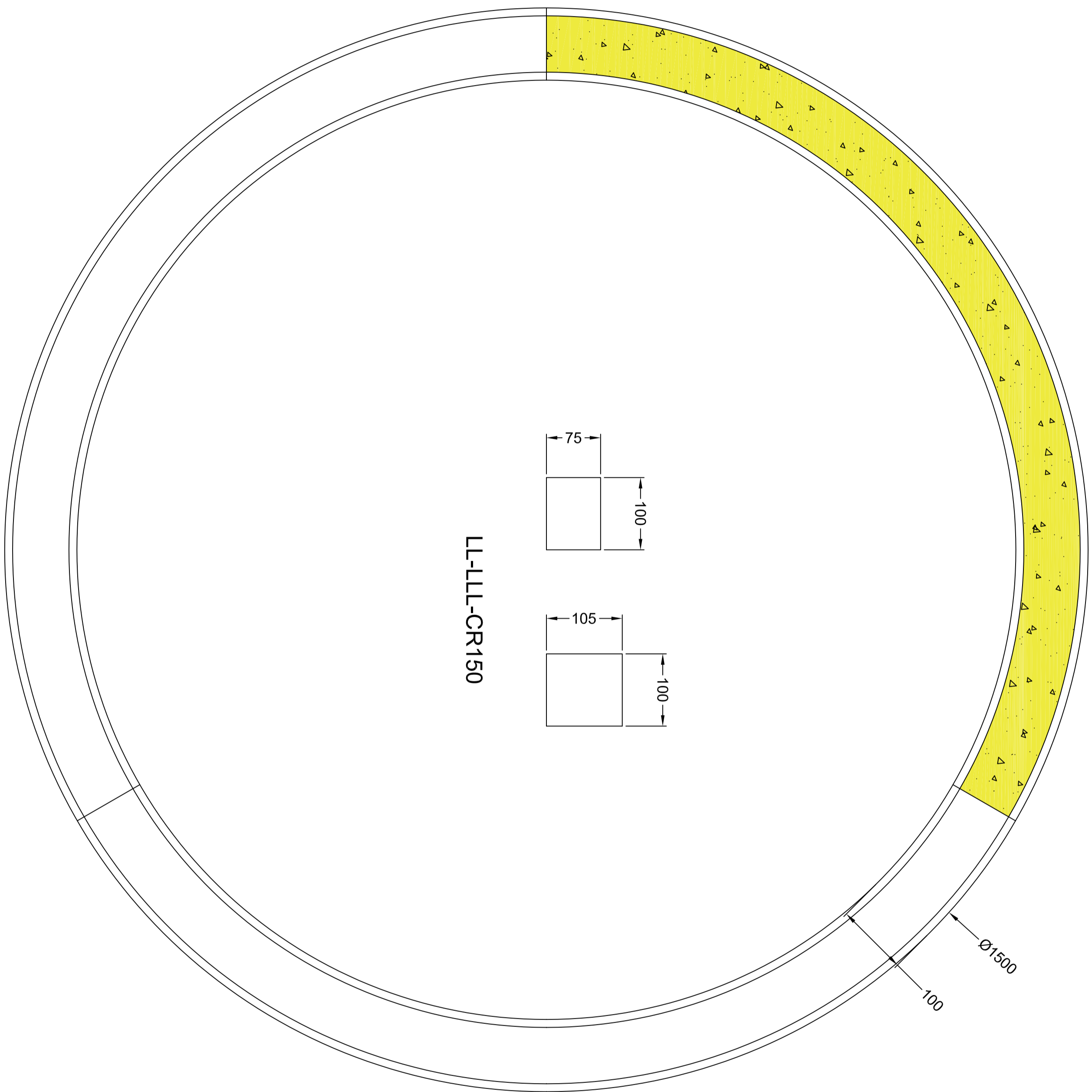

LL-LLL-CR150

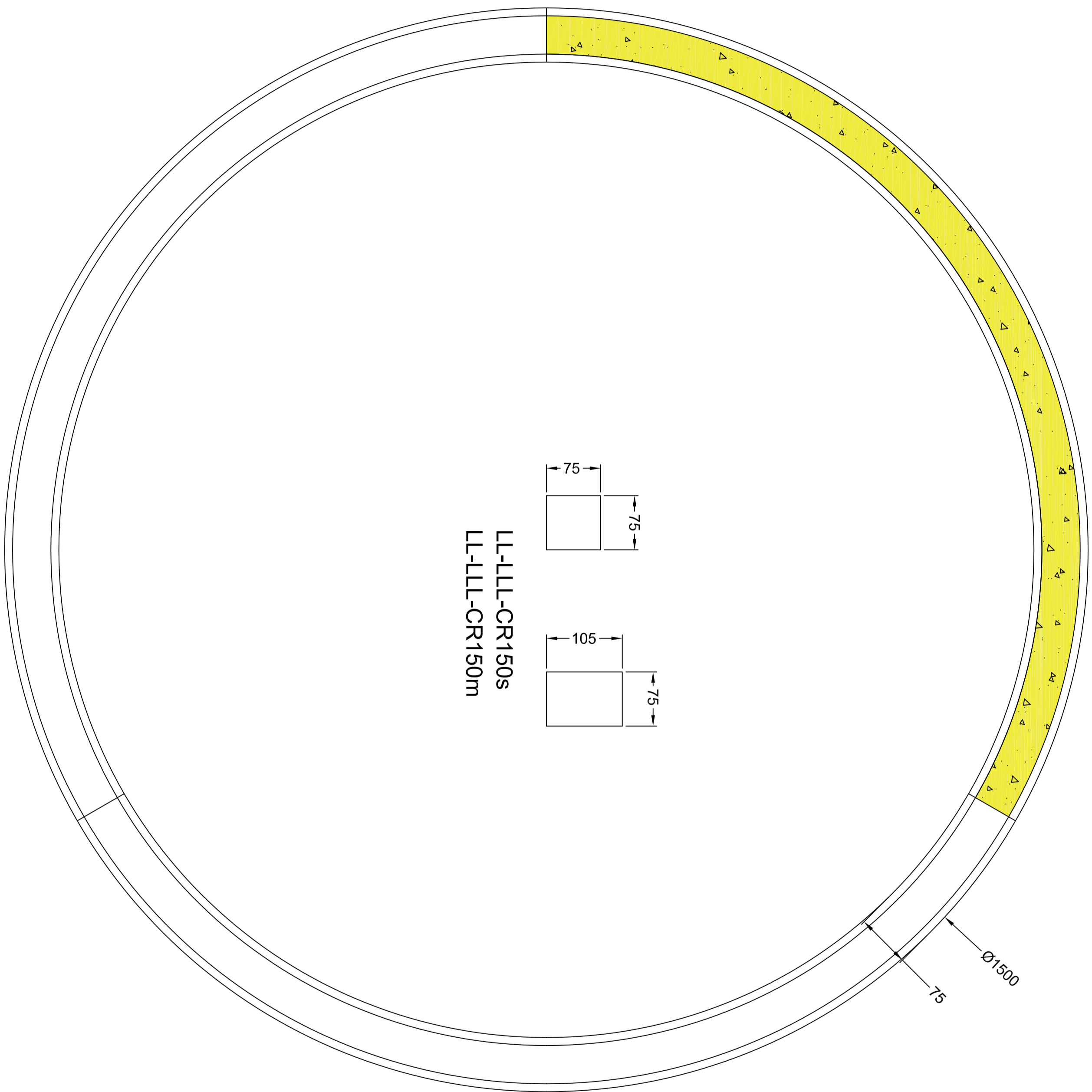

LL-LLL-CR150s  
LL-LLL-CR150m

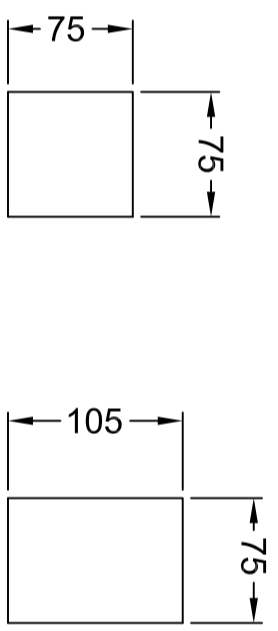

75  
Ø1500

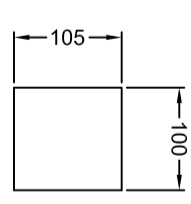
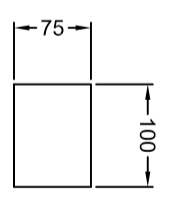
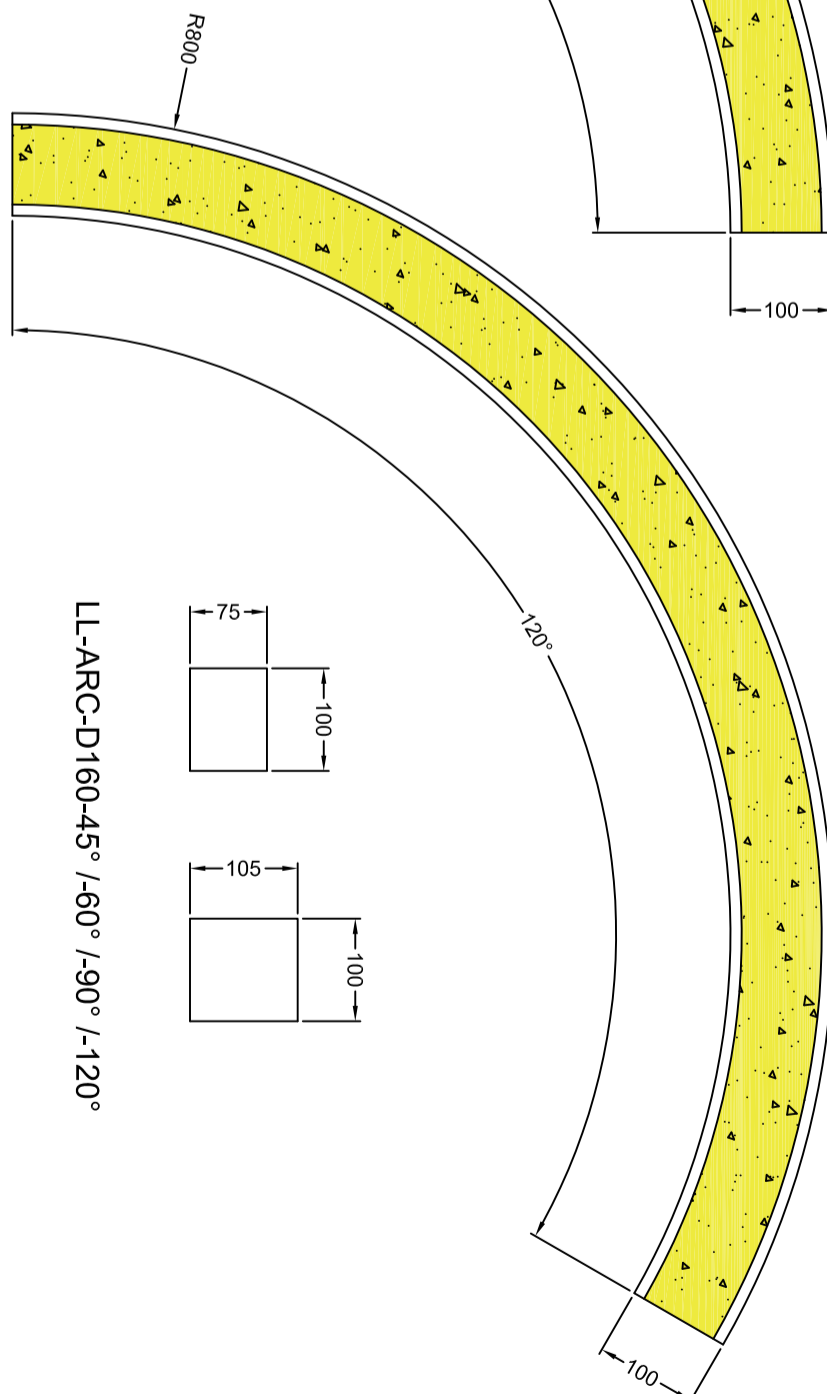
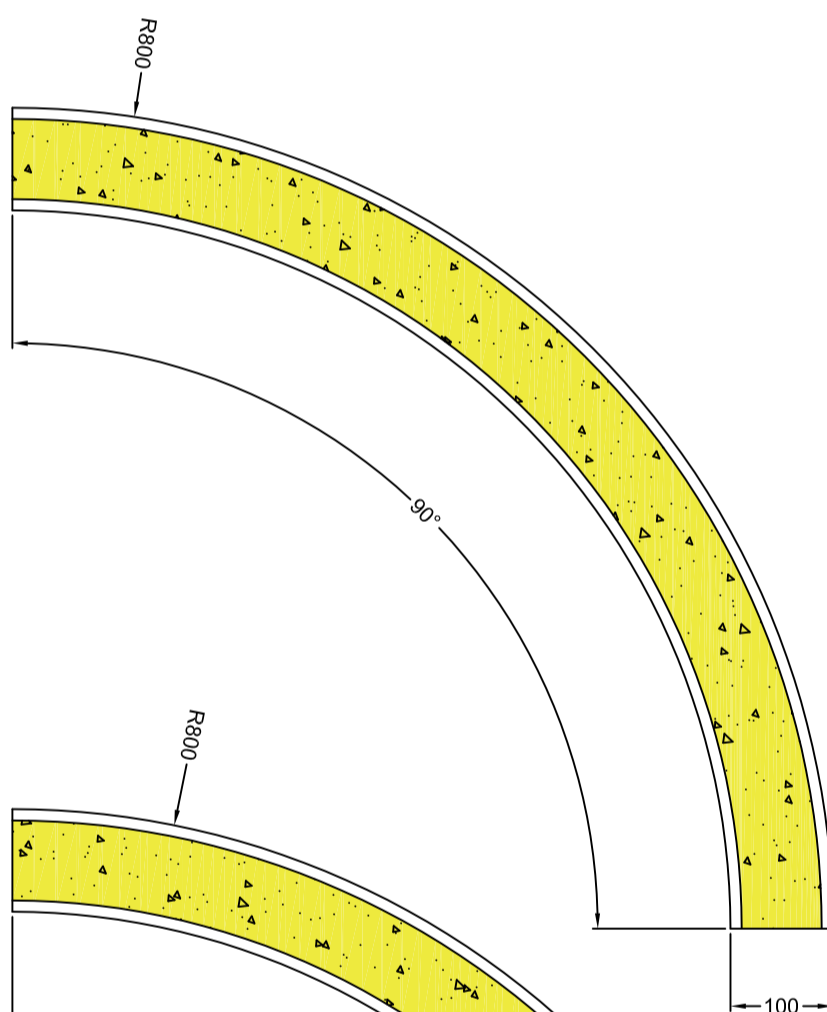
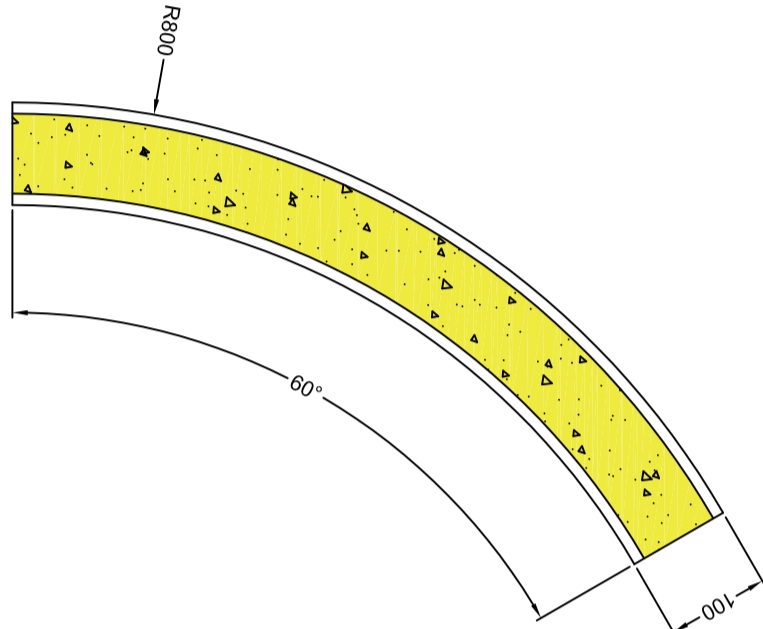
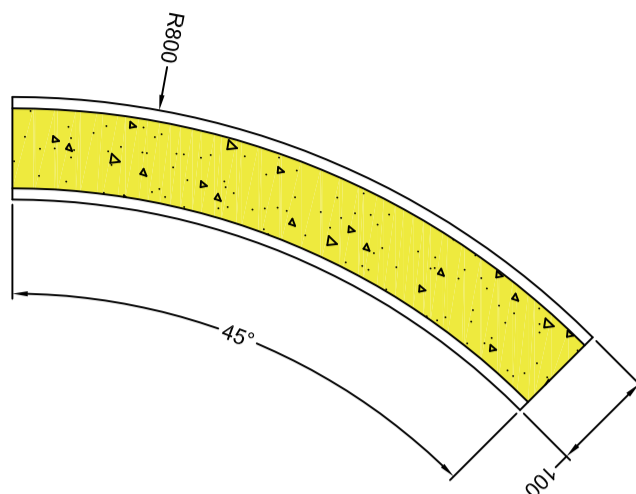

LL-ARC-D160-45° /-60° /-90° /-120°

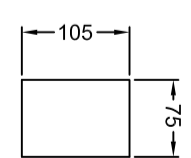
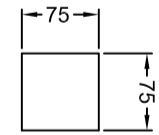
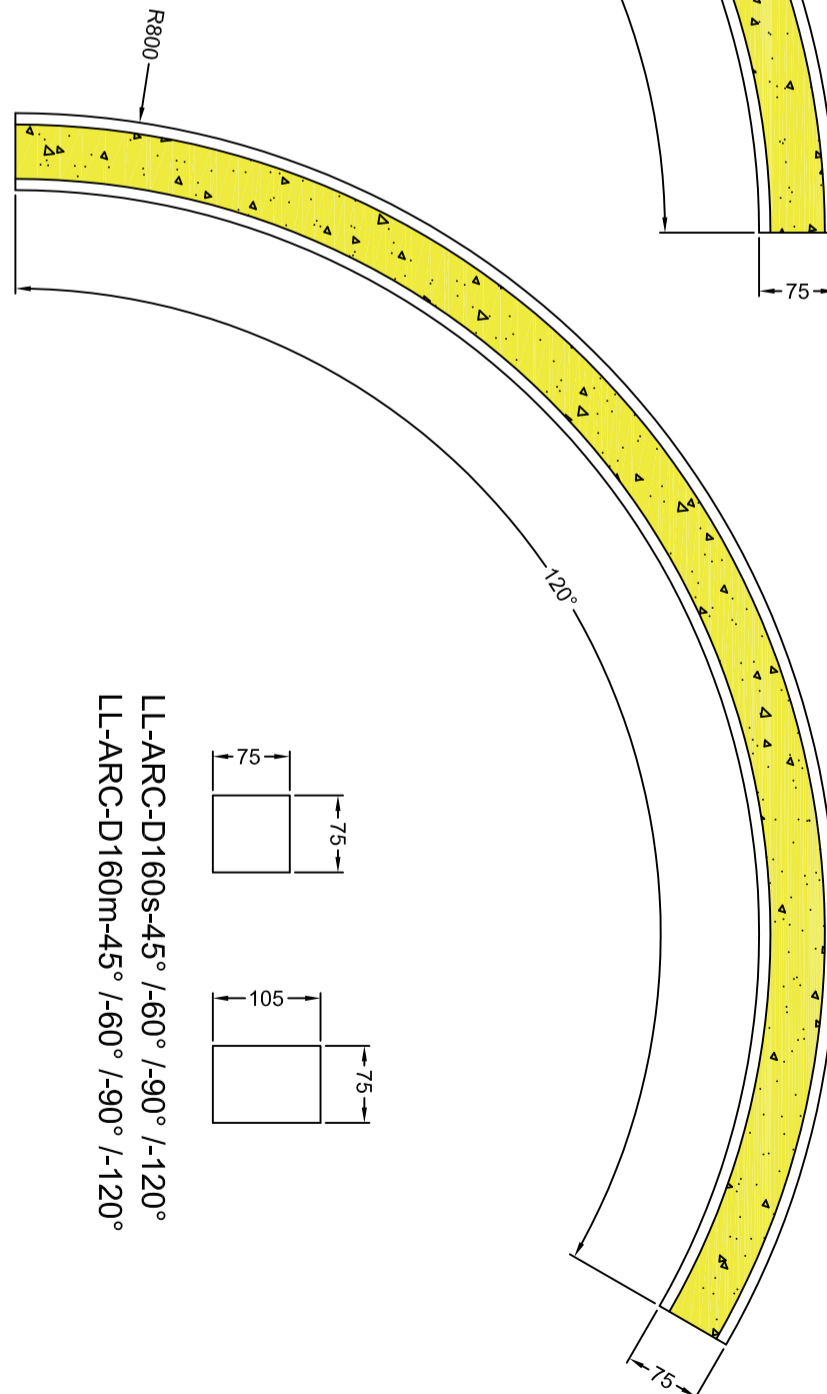
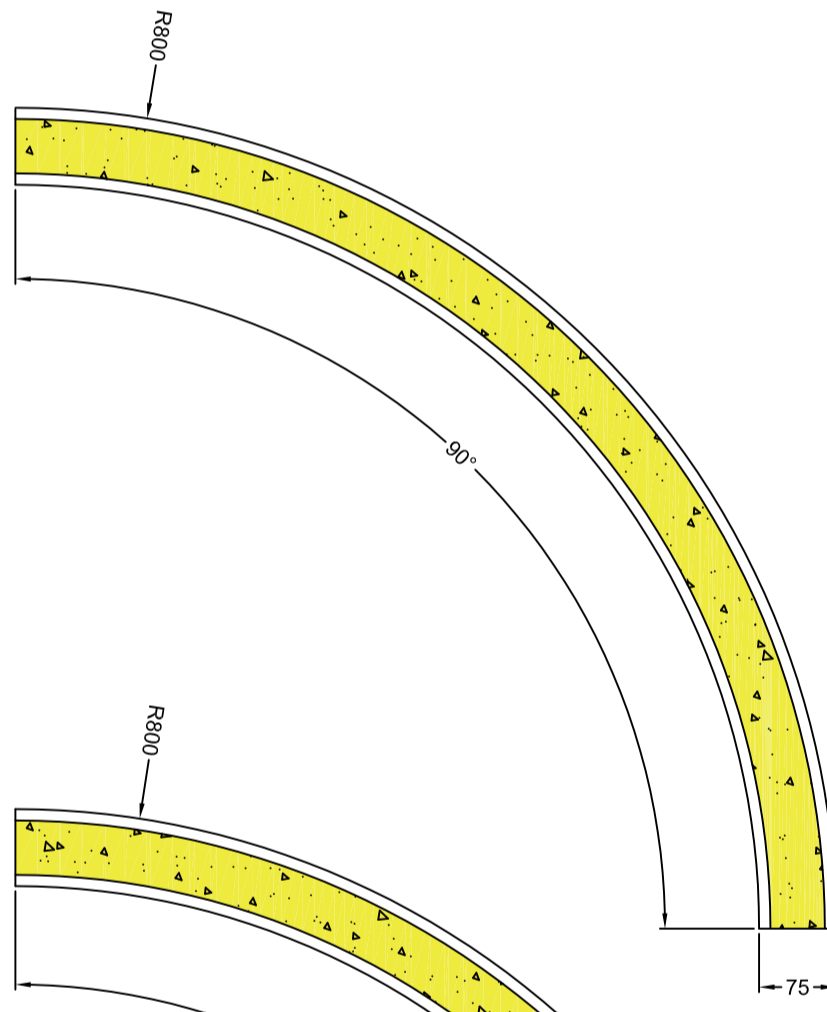
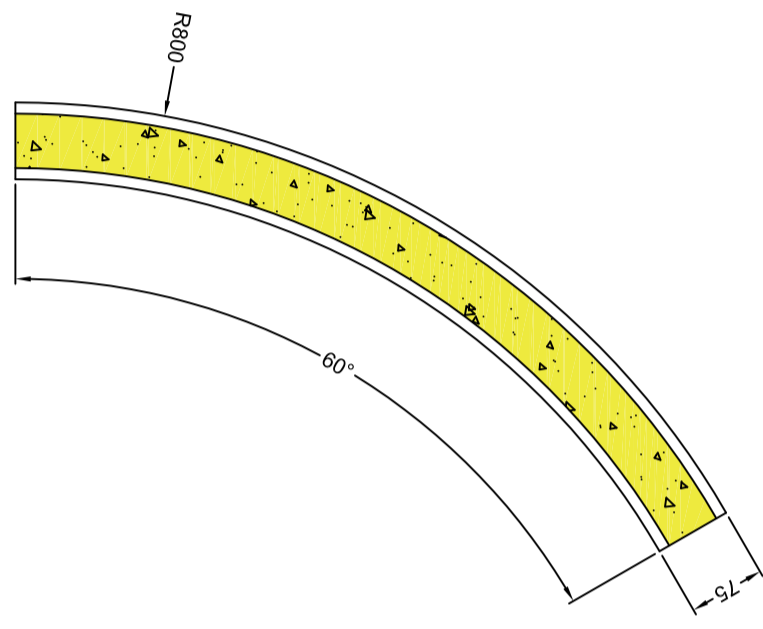
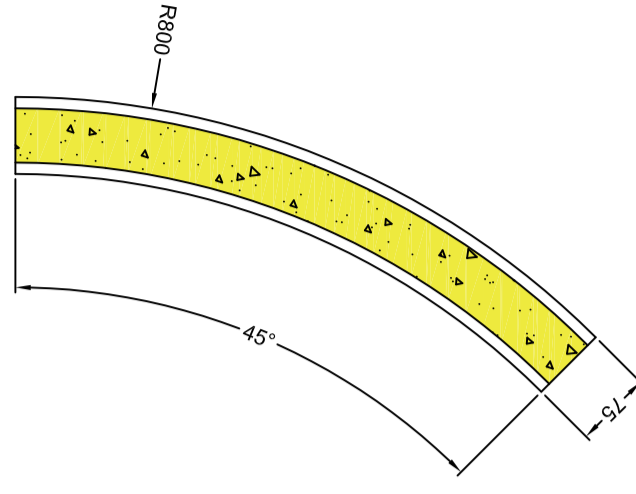

LL-ARC-D160s-45° /-60° /-90° /-120°  
 LL-ARC-D160m-45° /-60° /-90° /-120°



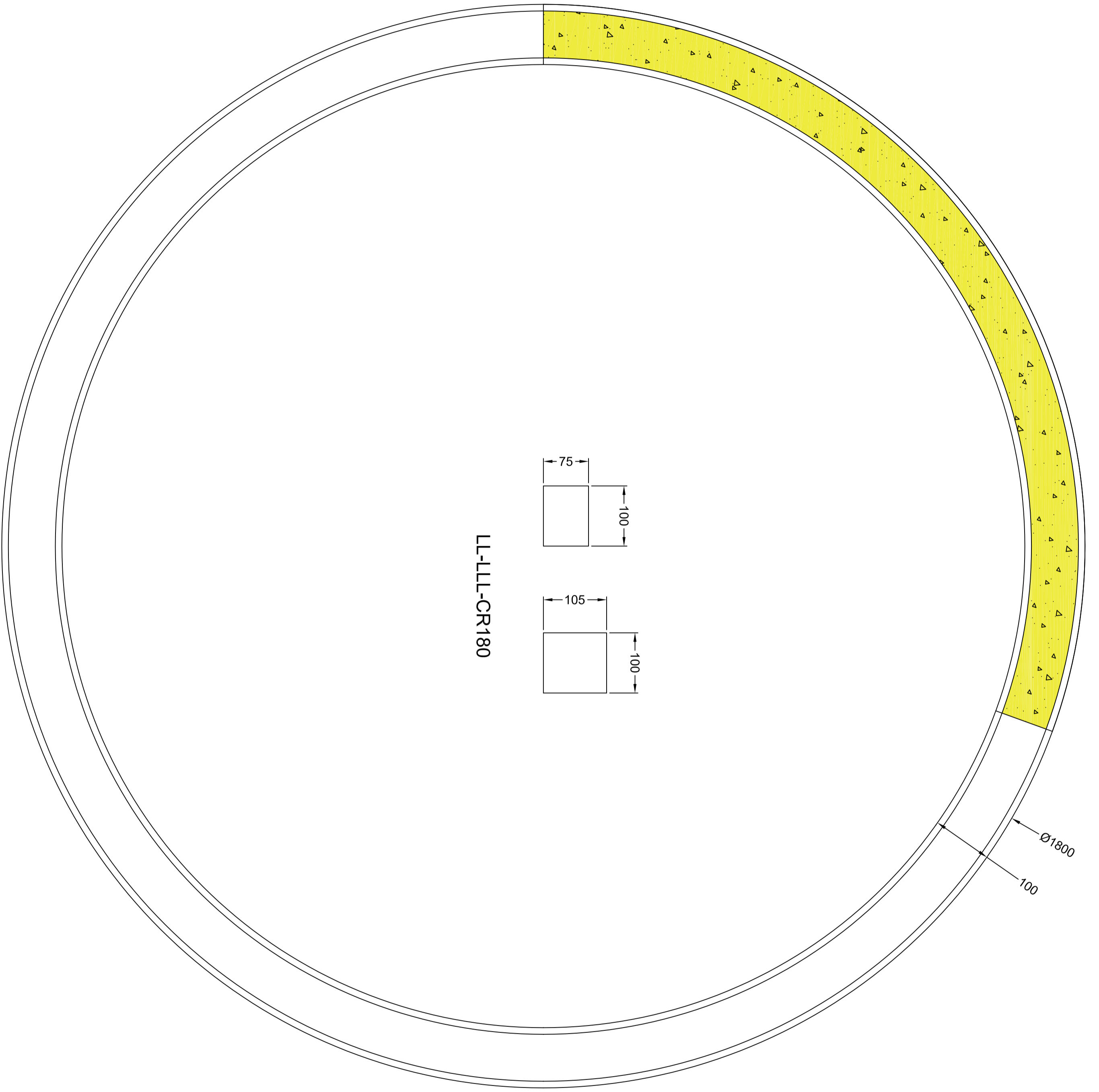

LL-LLL-CR180

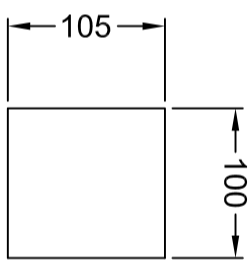
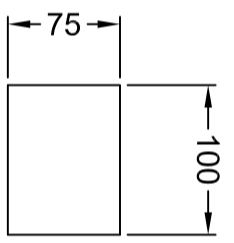

Ø1800  
100

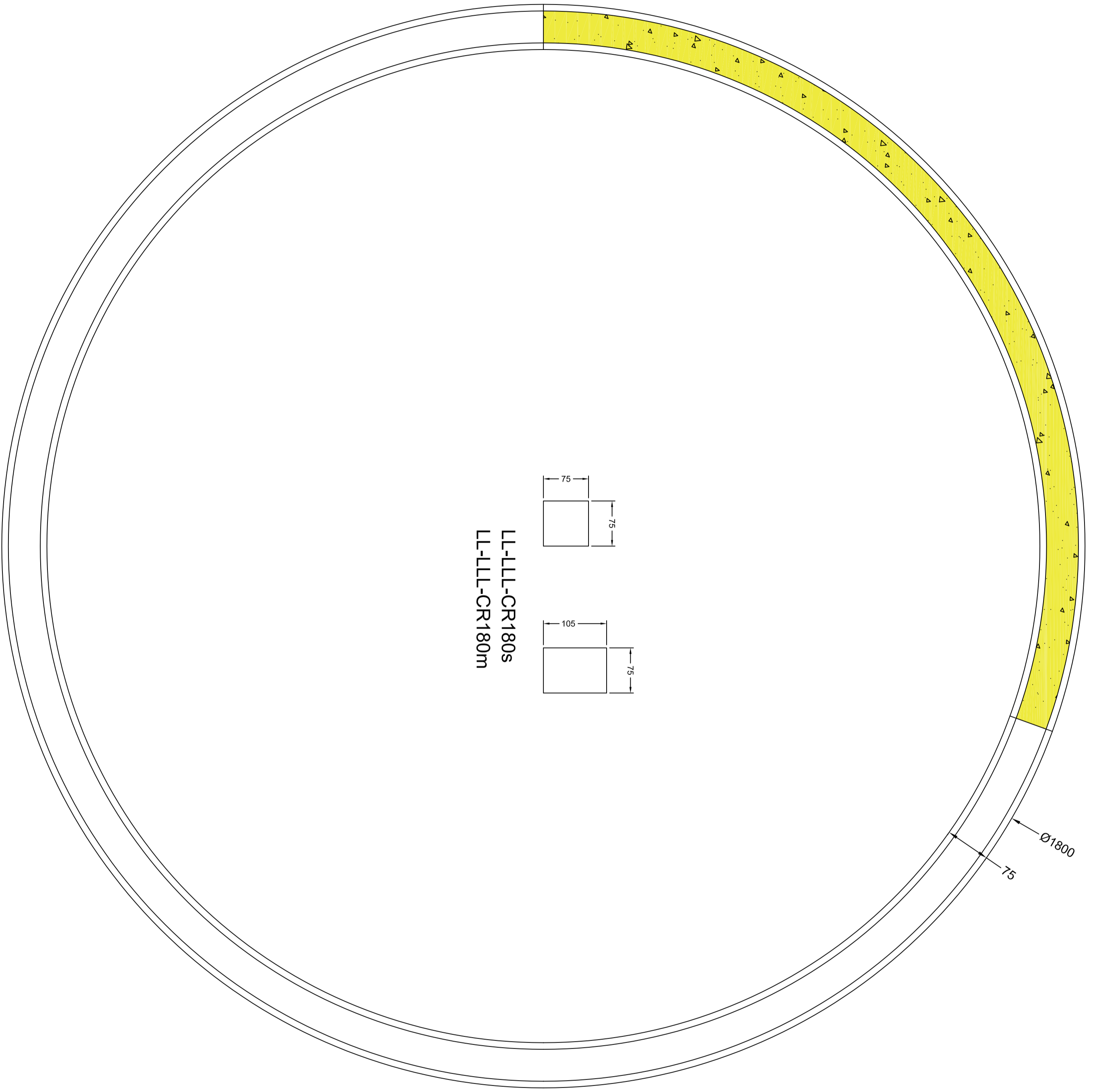

LL-LLL-CR180S  
LL-LLL-CR180m

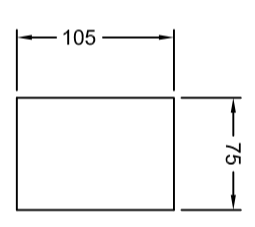
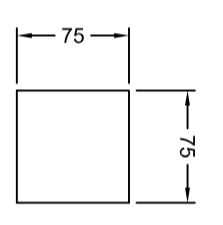

Ø1800  
75



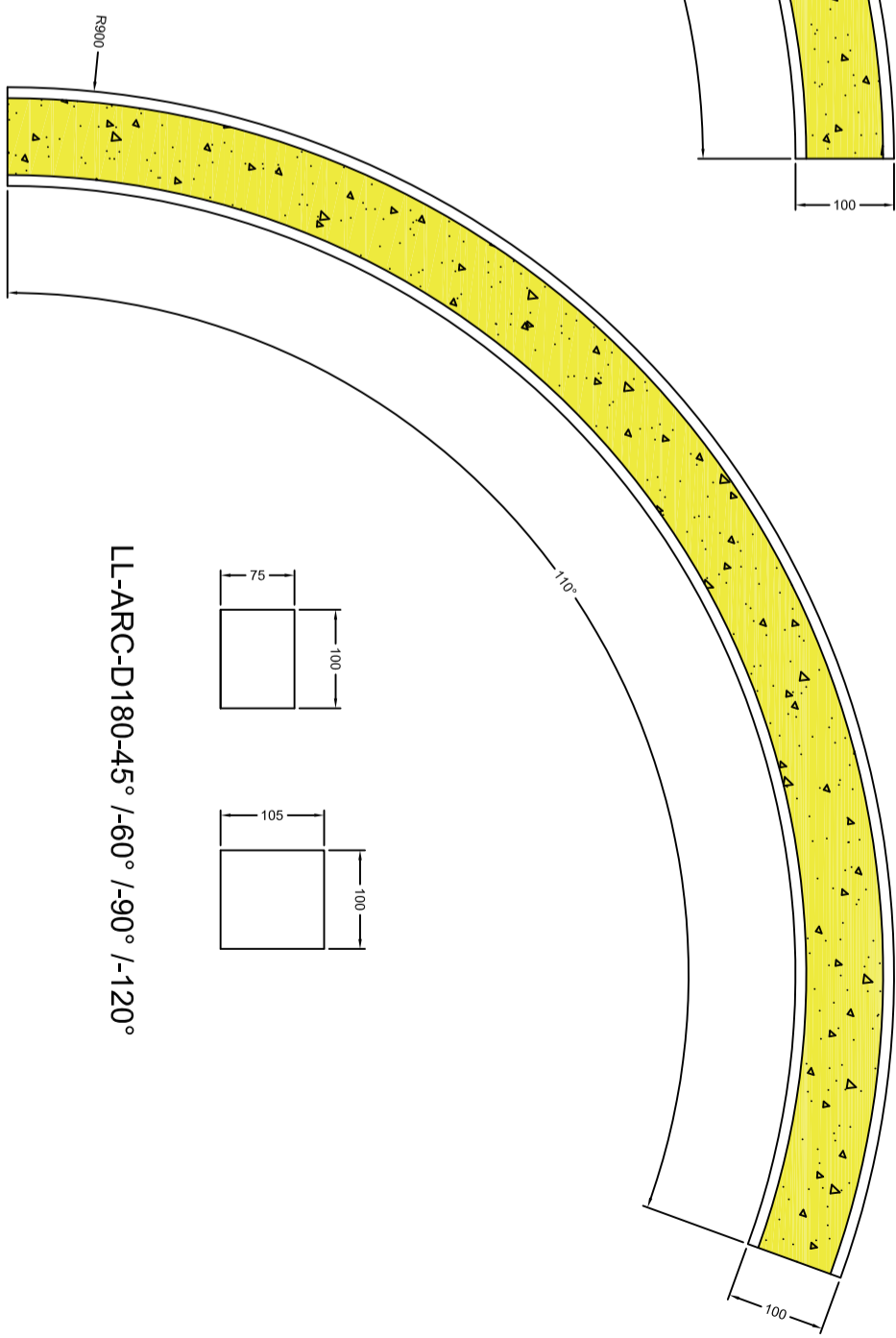
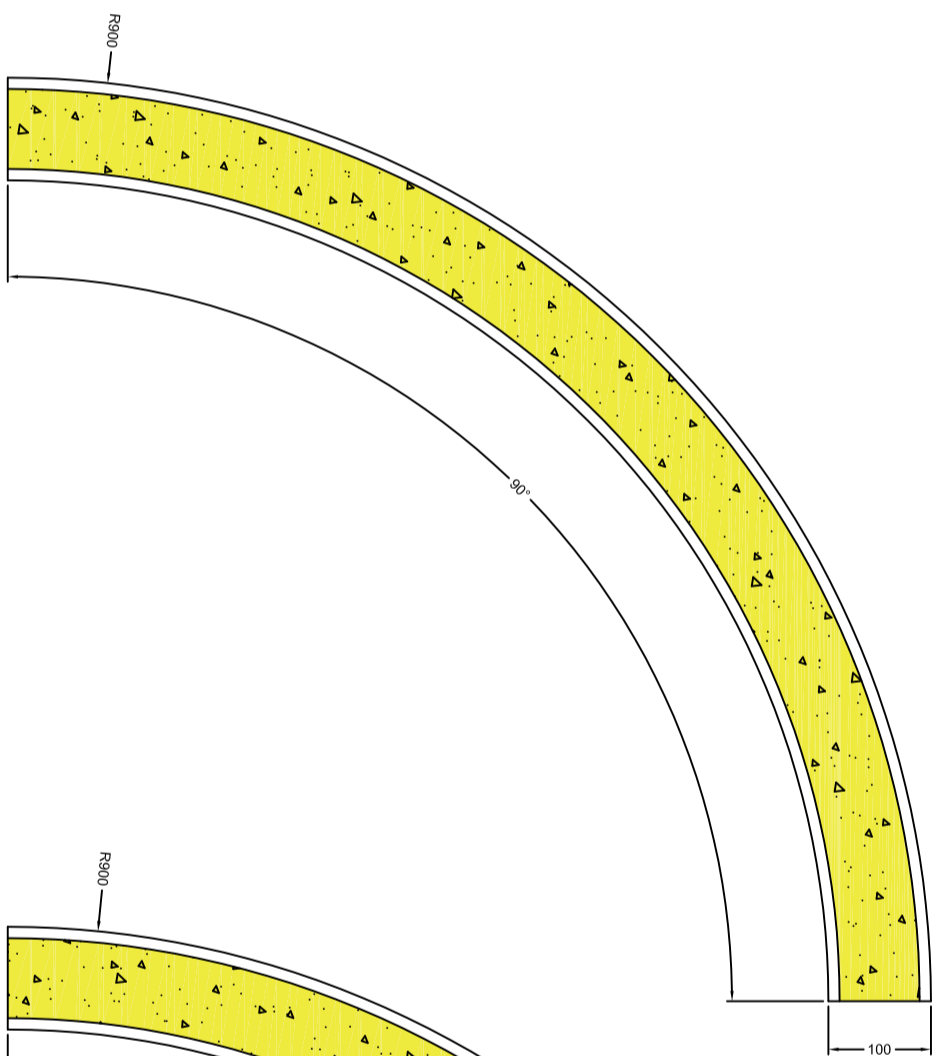
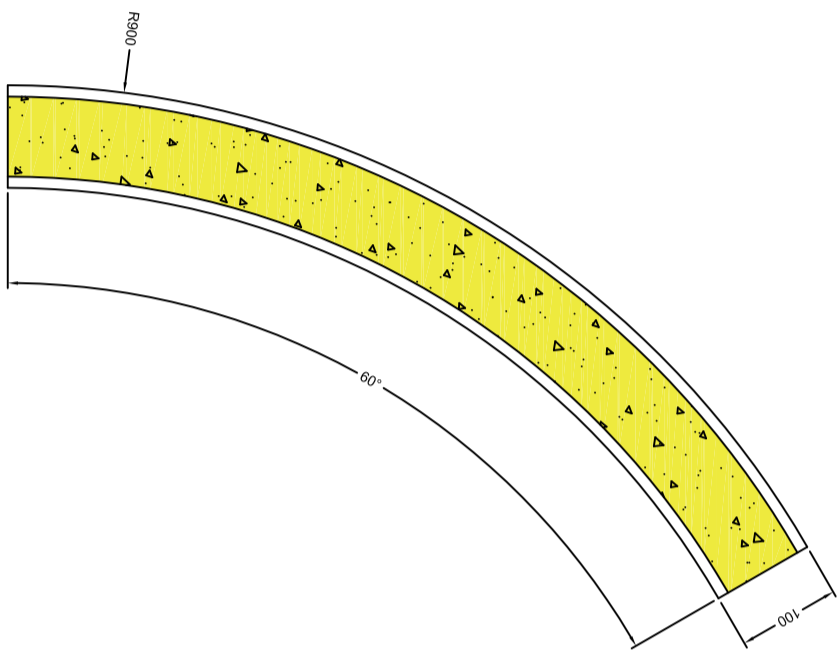
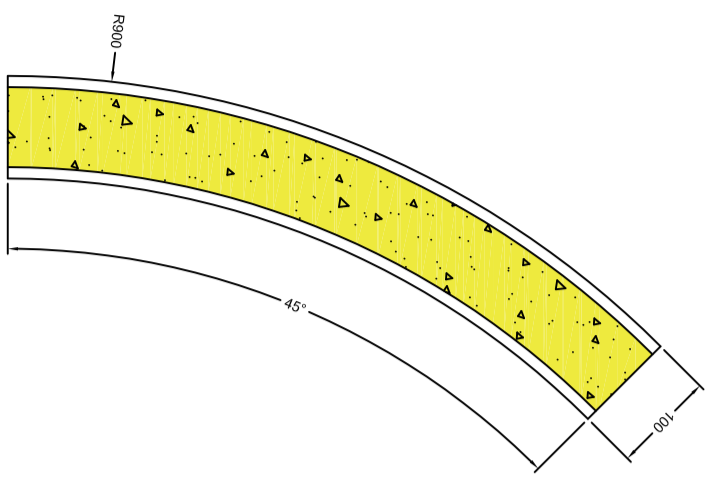

LL-ARC-D180-45° /-60° /-90° /-120°

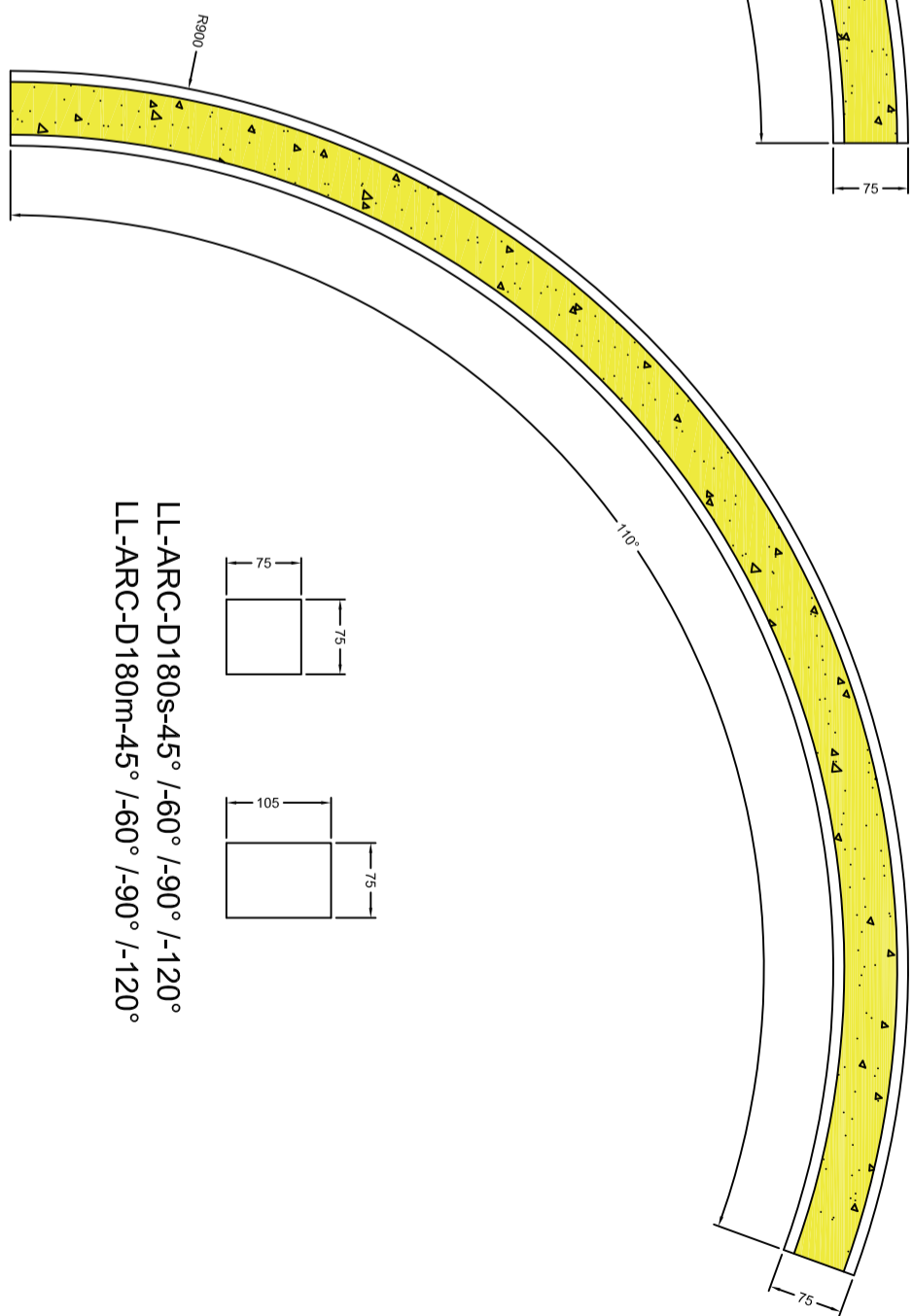
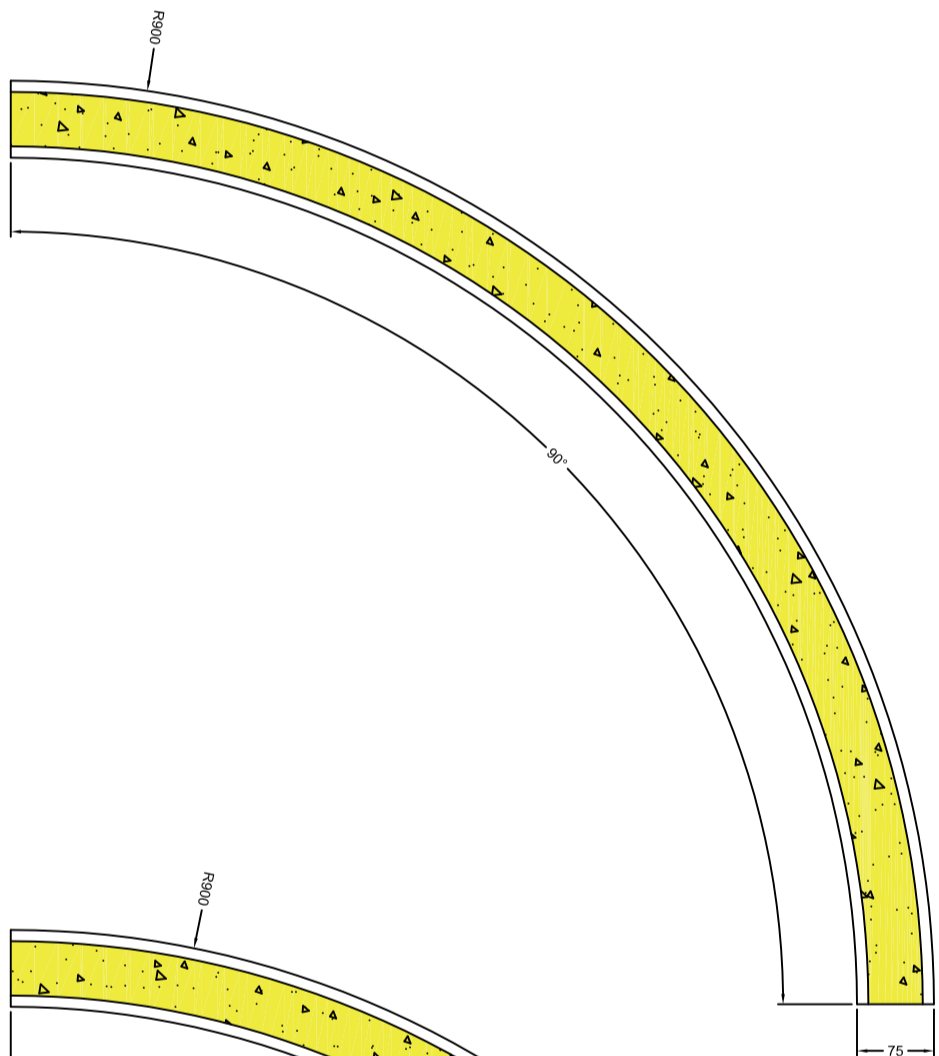
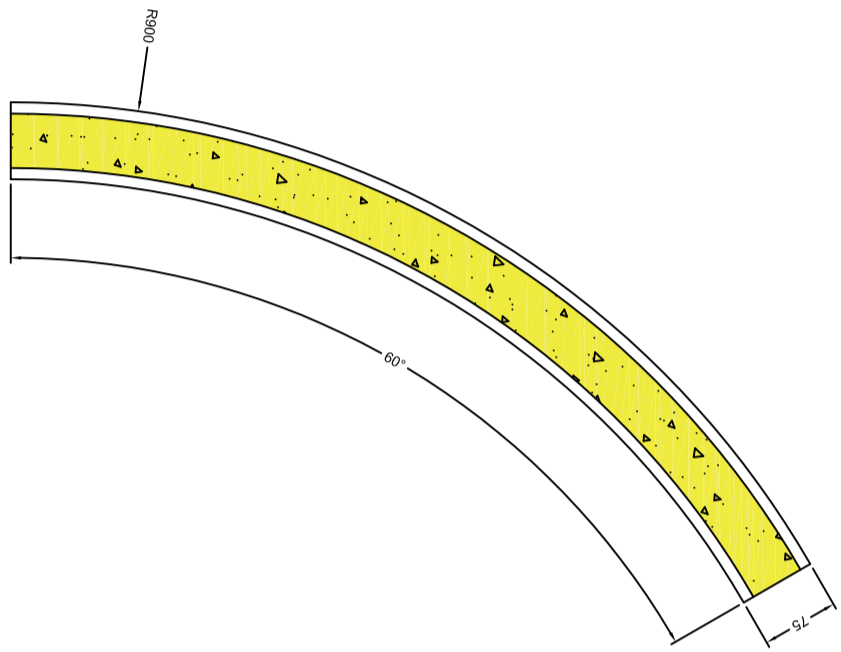
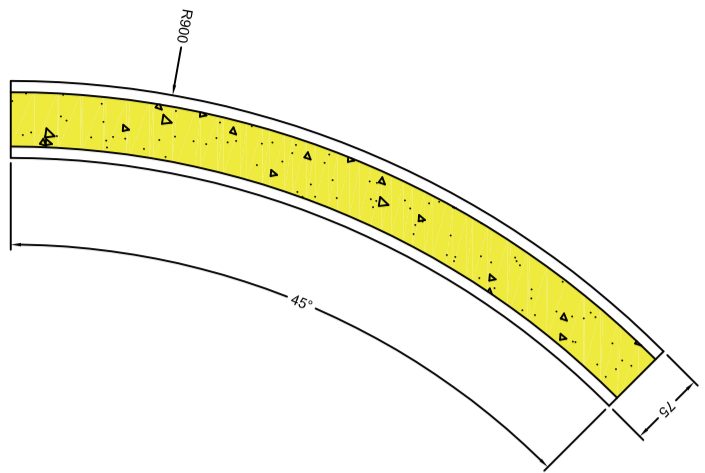
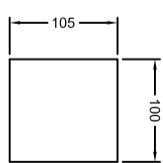
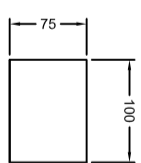

LL-ARC-D180s-45° /-60° /-90° /-120°  
 LL-ARC-D180m-45° /-60° /-90° /-120°

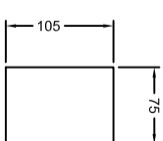
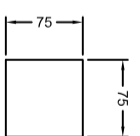

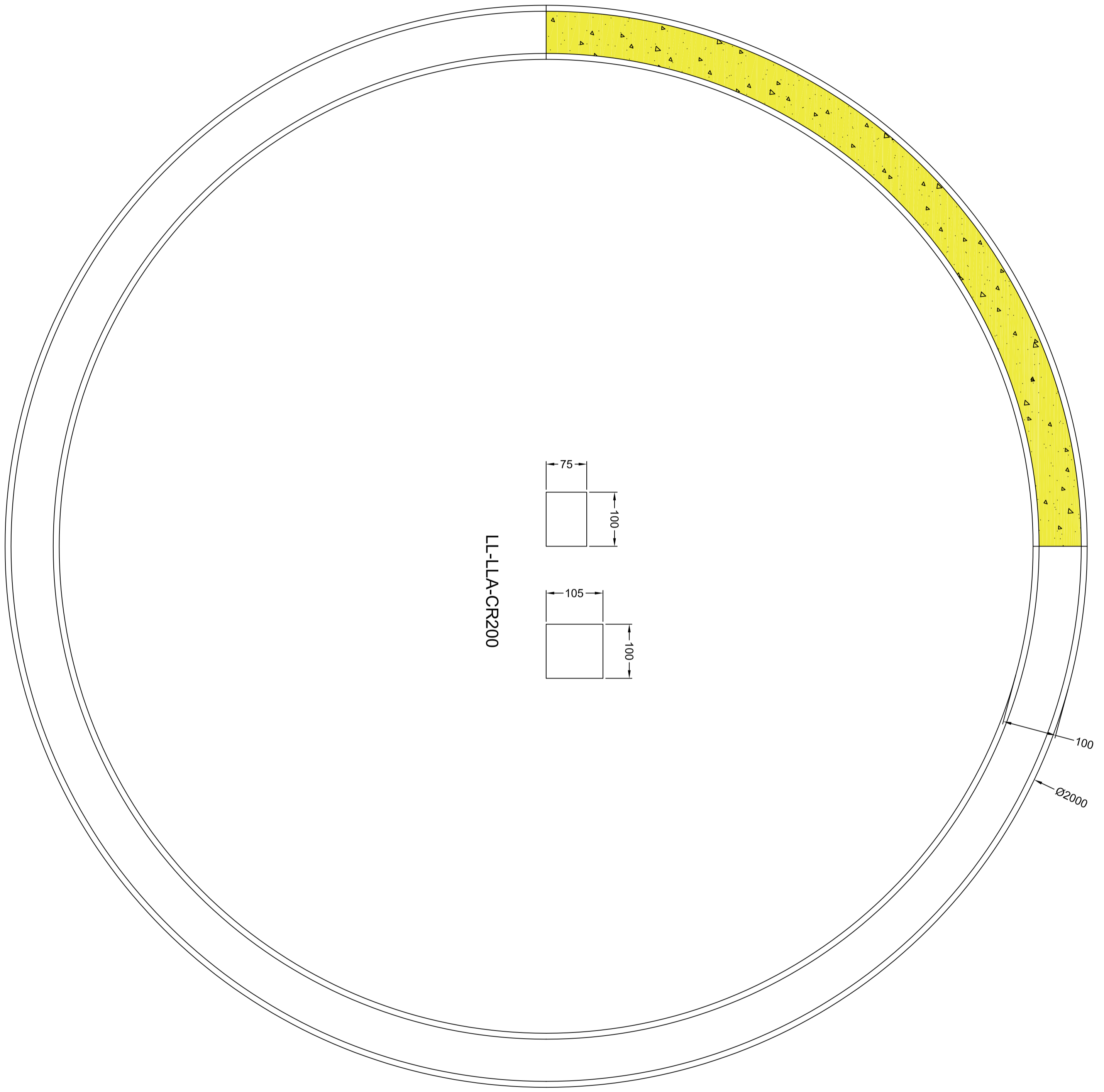

LL-LLA-CR200

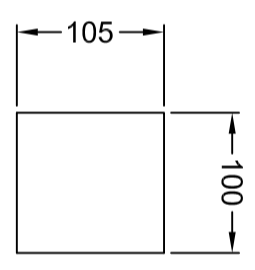
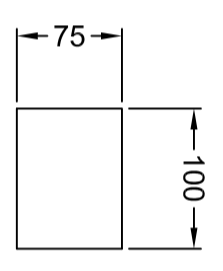

100

Ø2000

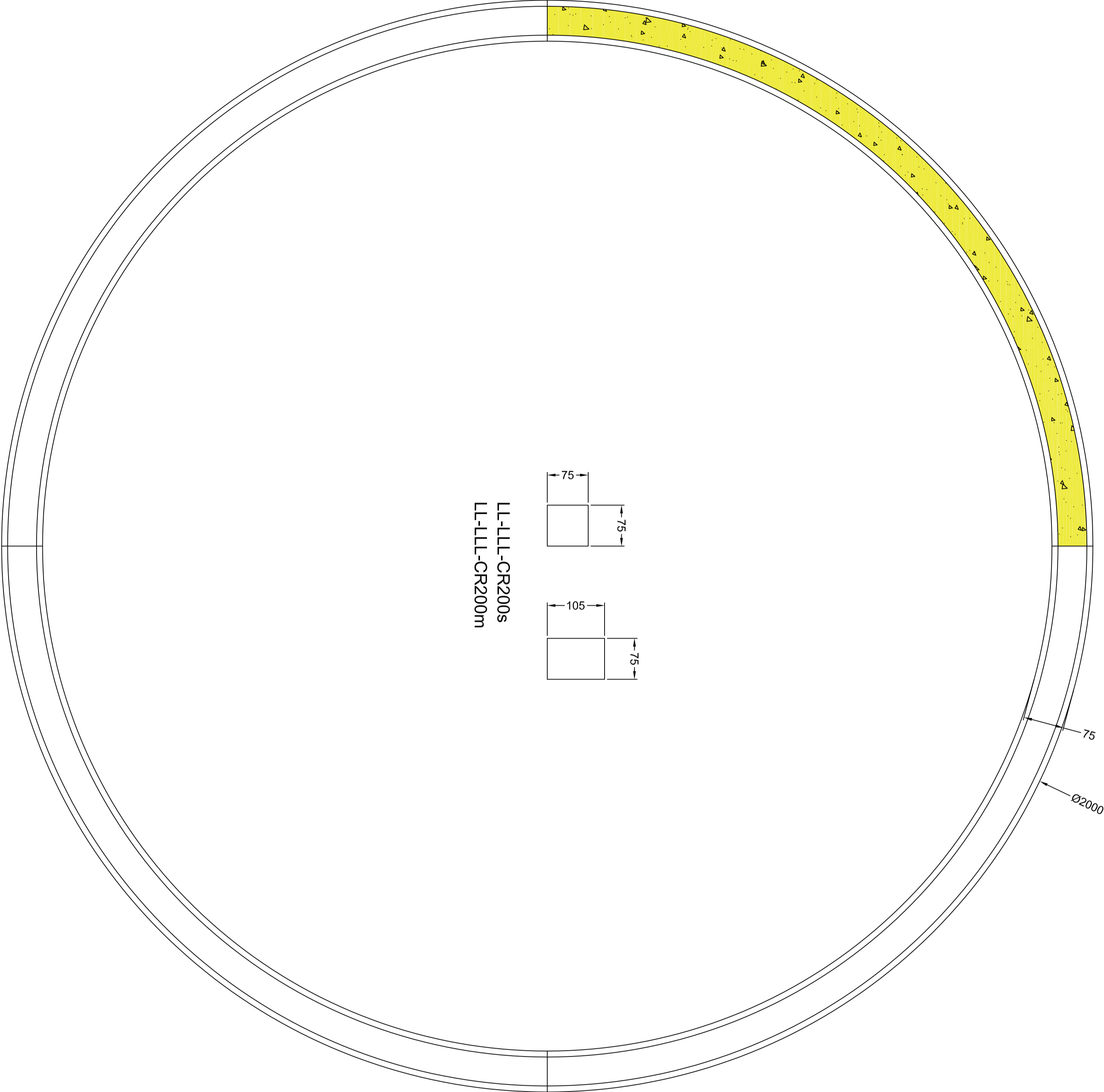

LL-LLL-CR200s  
LL-LLL-CR200m

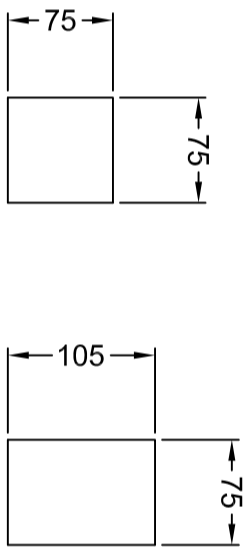

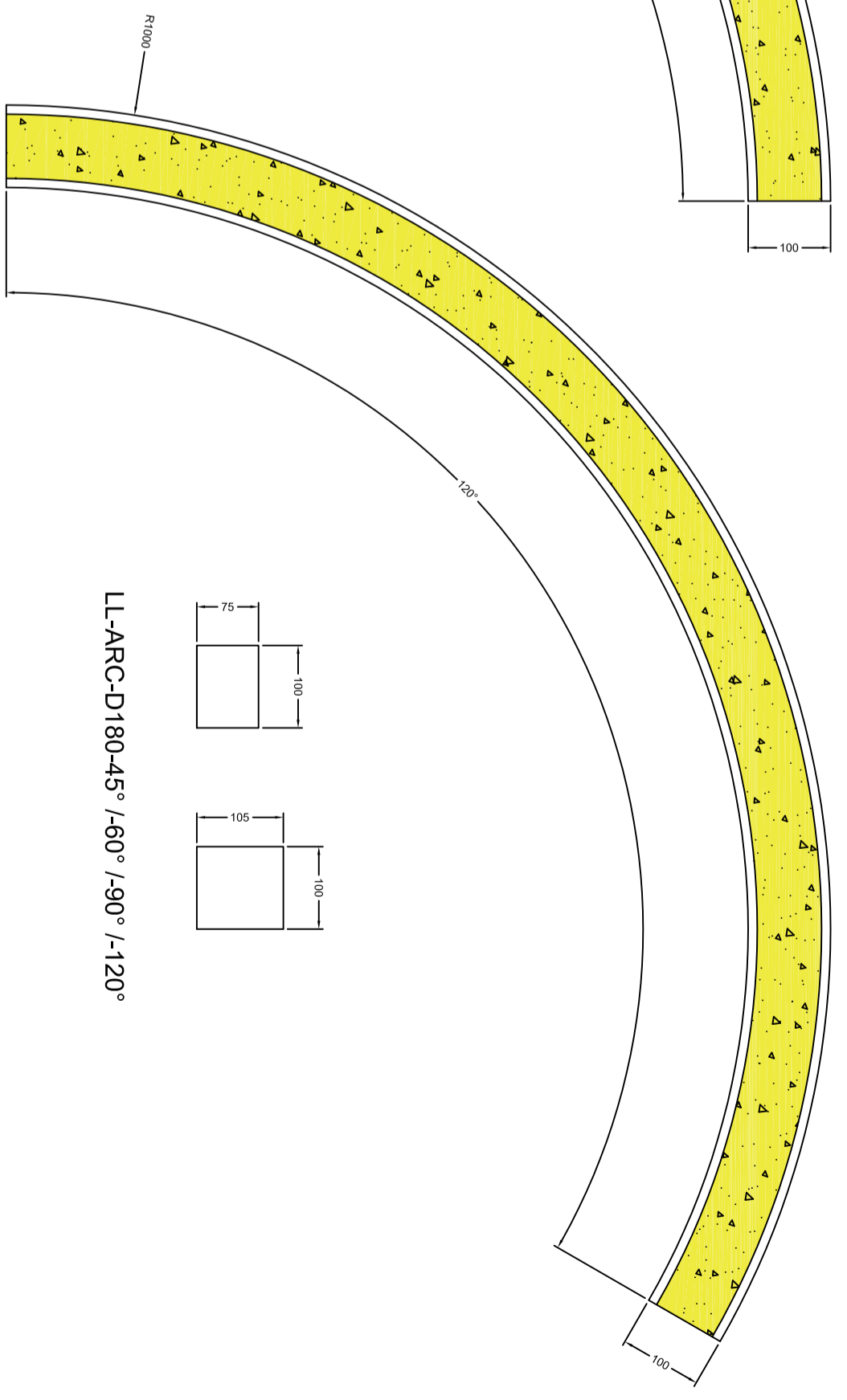
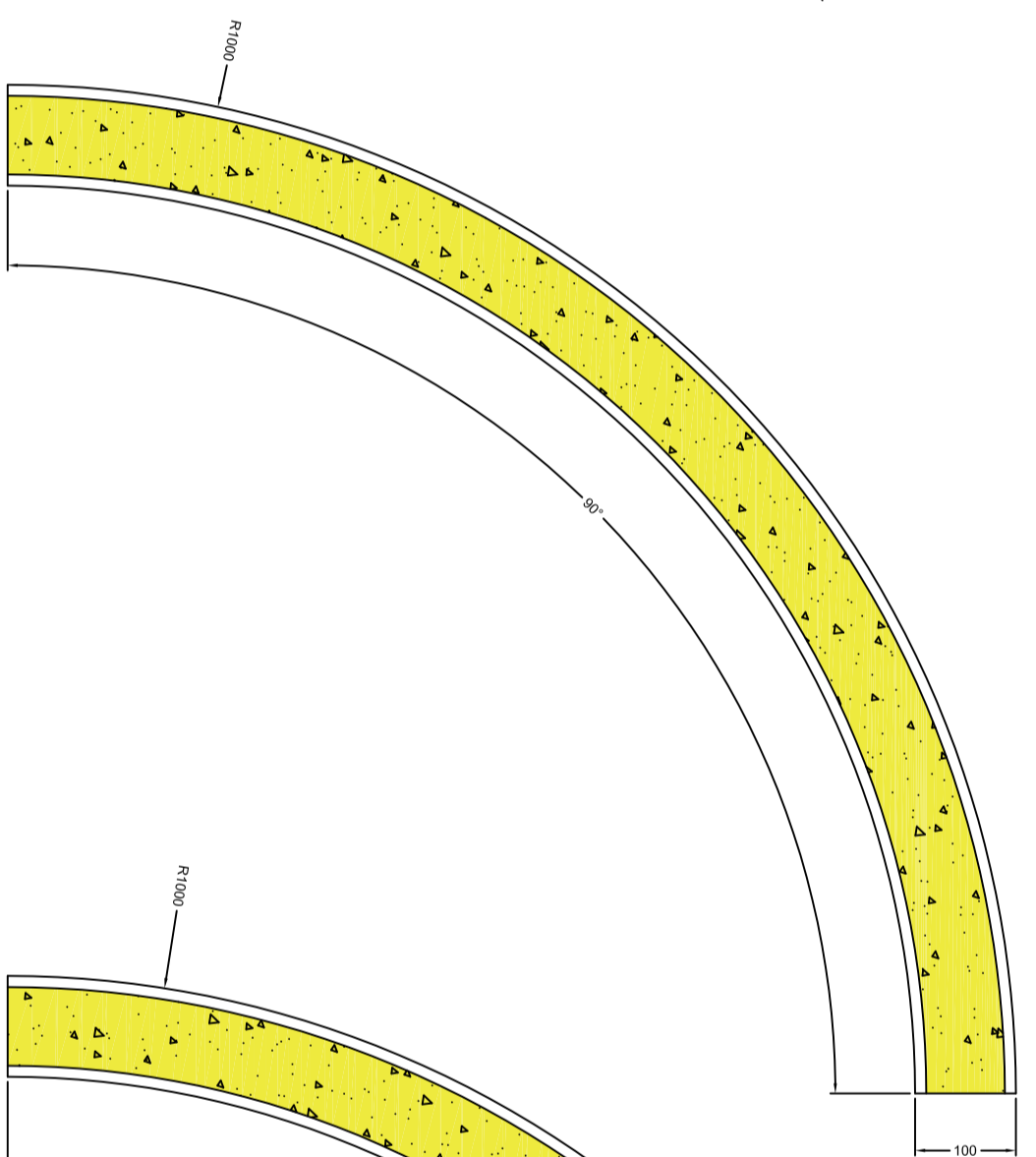
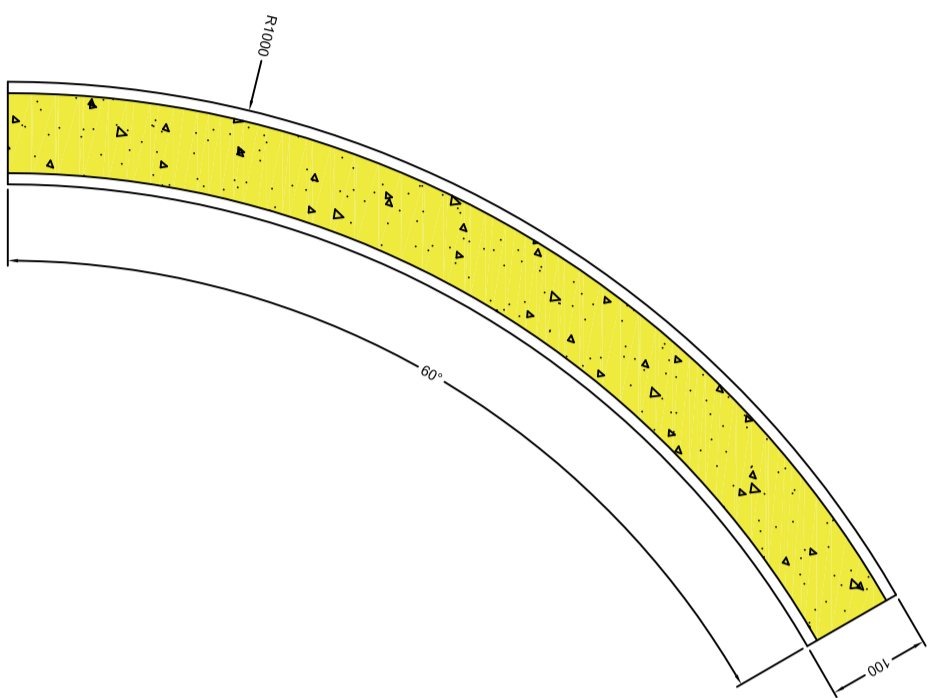
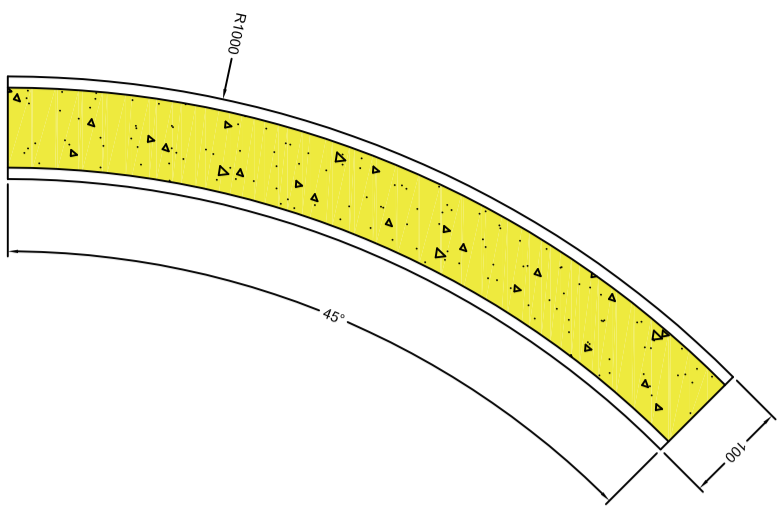

LL-ARC-D180-45° /60° /90° /120°

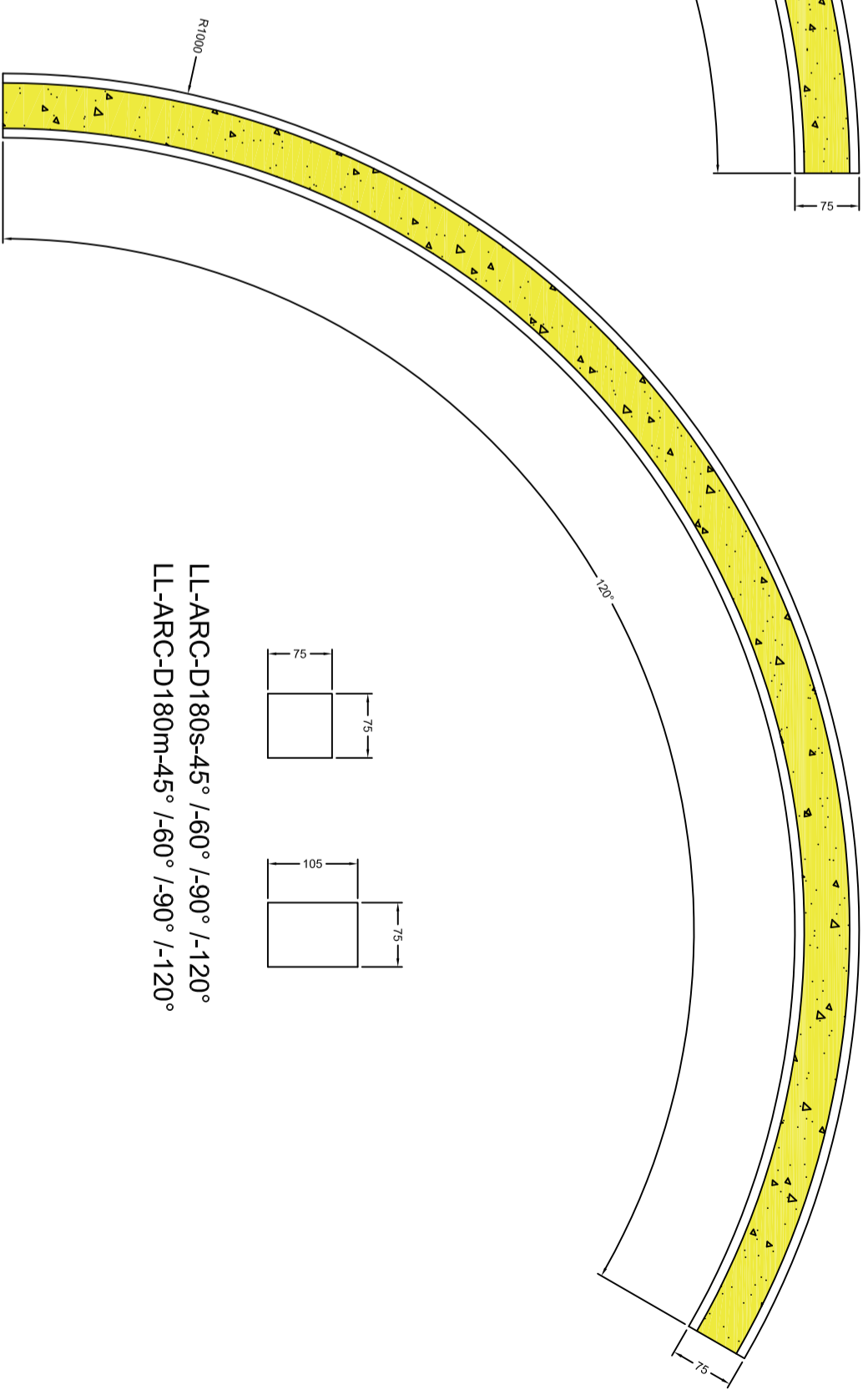
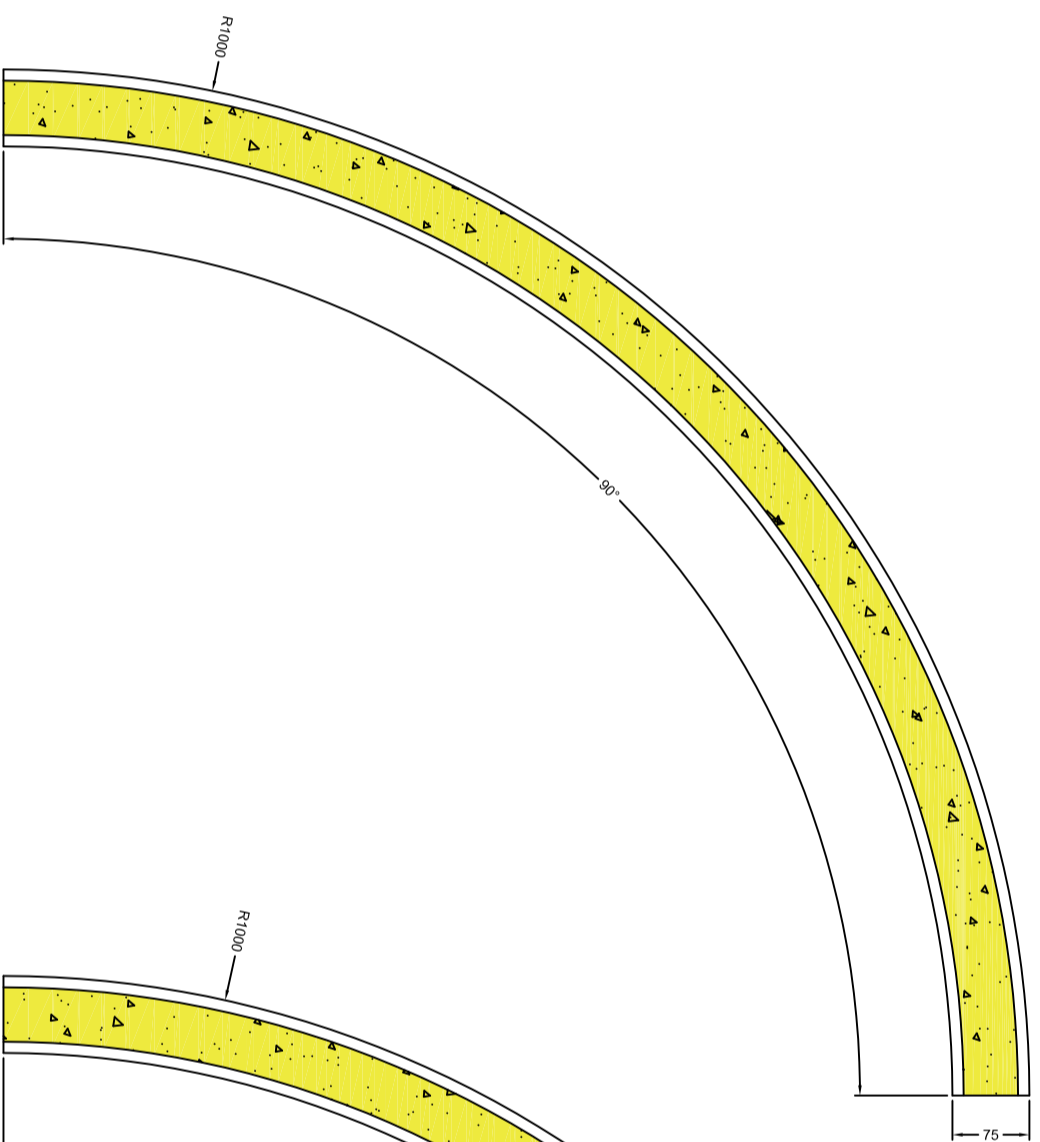
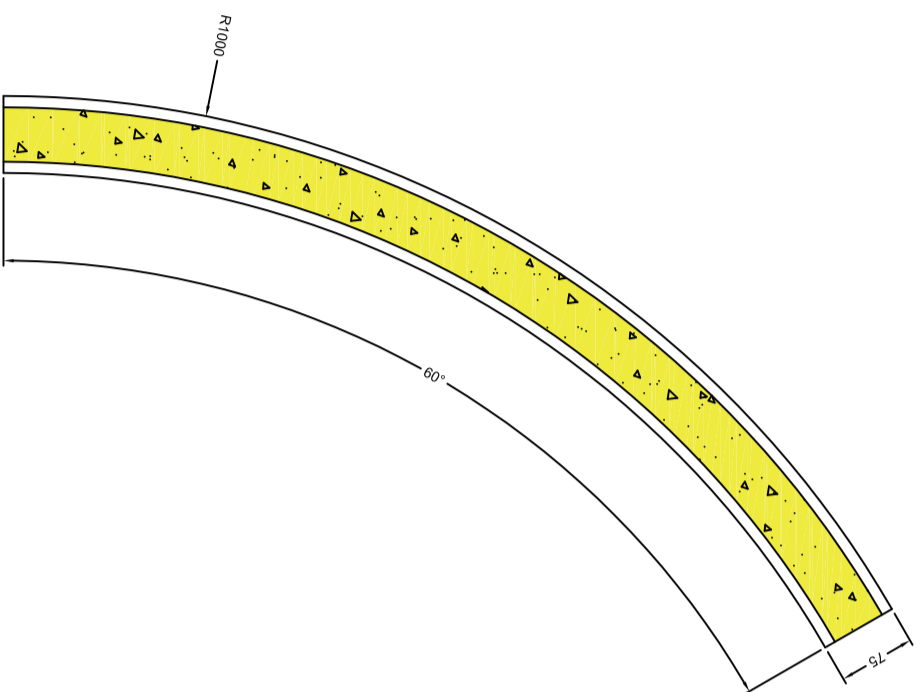
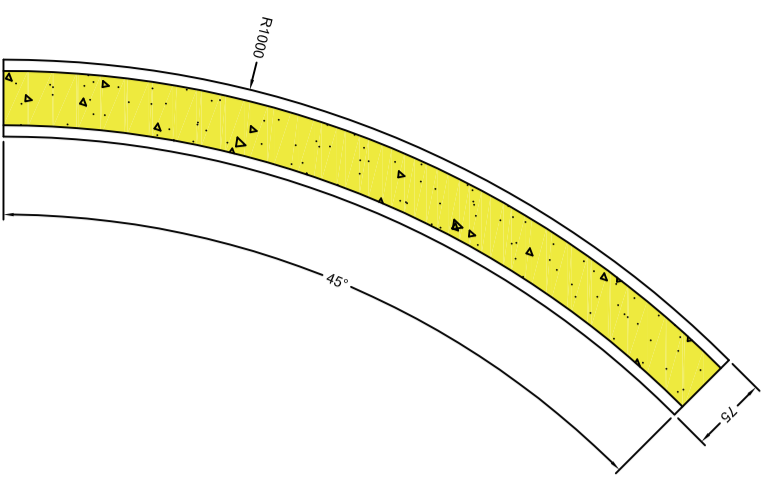
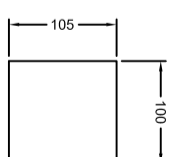
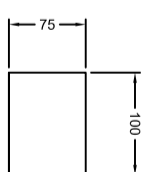

LL-ARC-D180s-45° /60° /90° /120°  
 LL-ARC-D180m-45° /60° /90° /120°

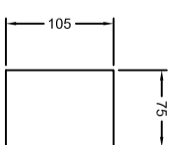
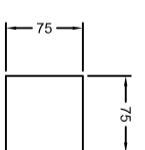

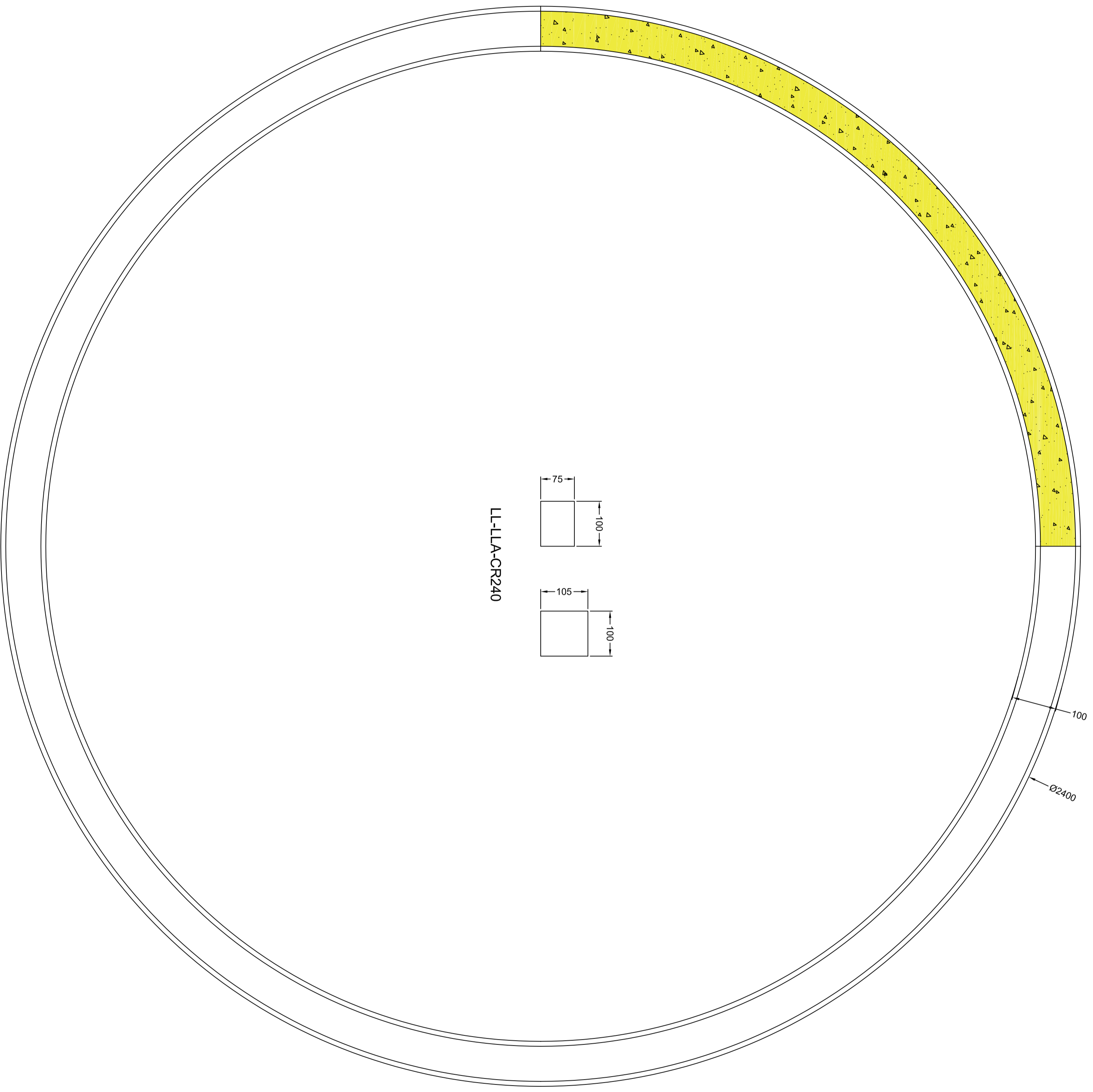

LL-LLA-CR240

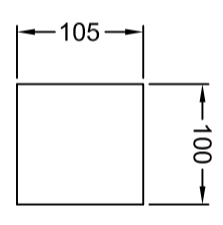
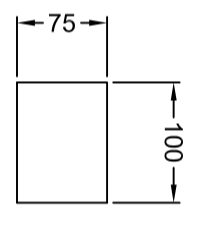

100

Ø2400



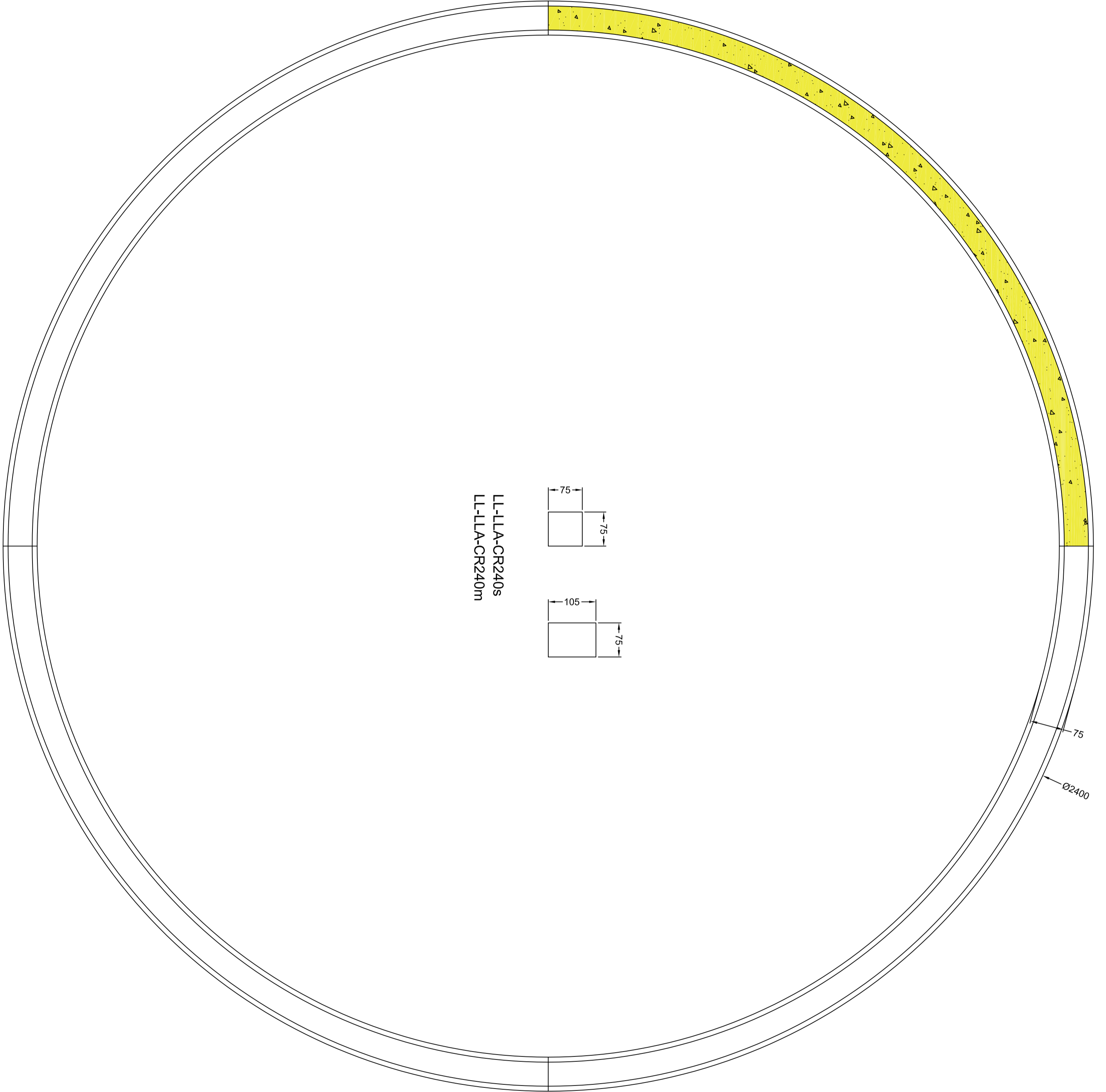

LL-LLA-CR240s  
LL-LLA-CR240m

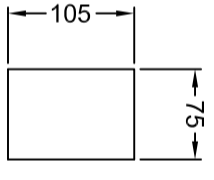
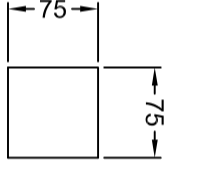

75  
Ø2400



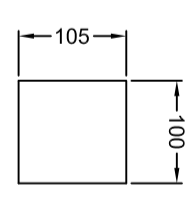
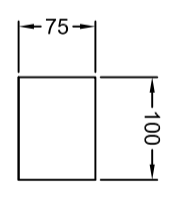
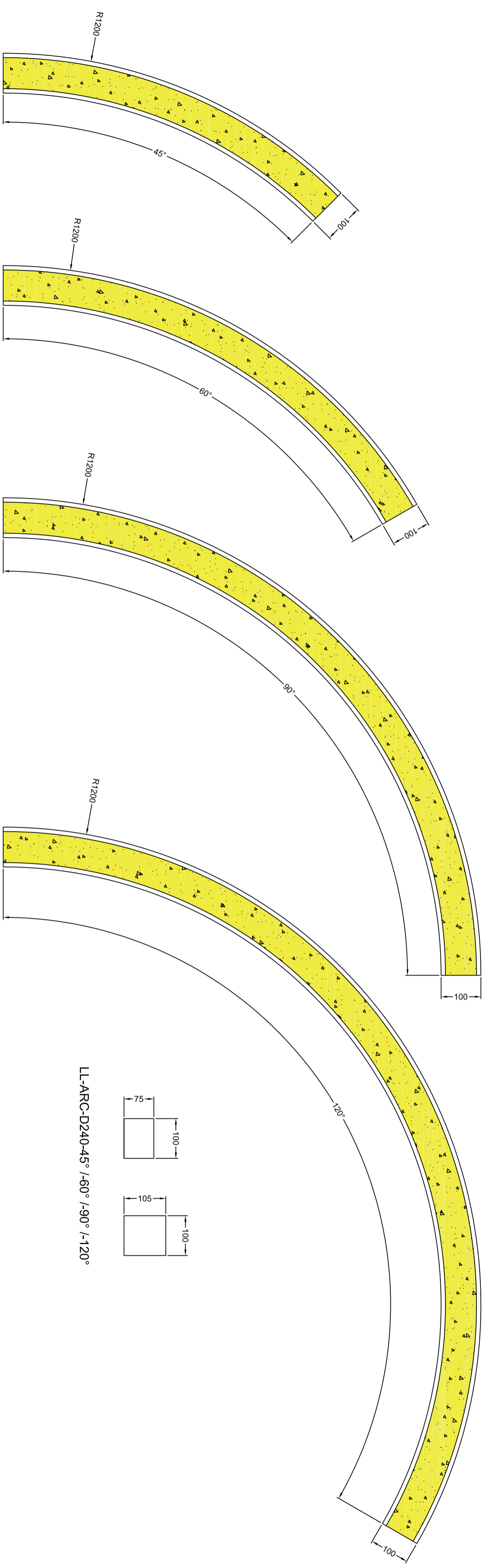

LL-ARC-D240-45° / 60° / 90° / 120°

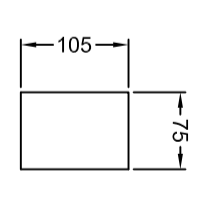
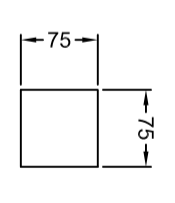
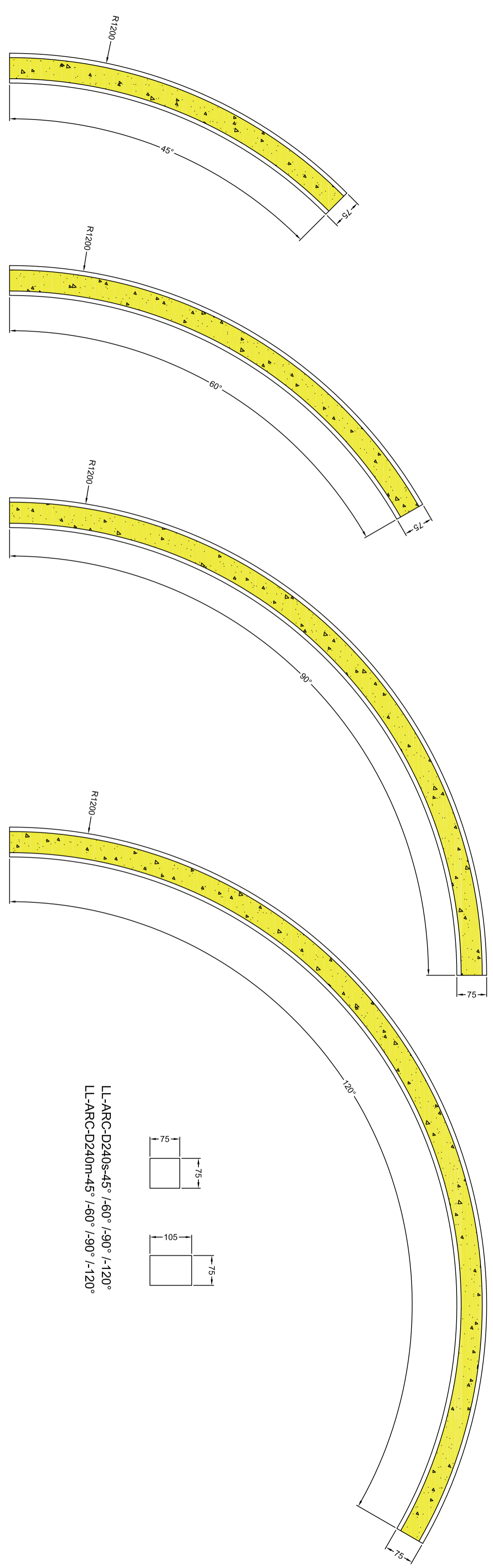

LL-ARC-D240S-45° / 60° / 90° / 120°  
LL-ARC-D240m-45° / 60° / 90° / 120°

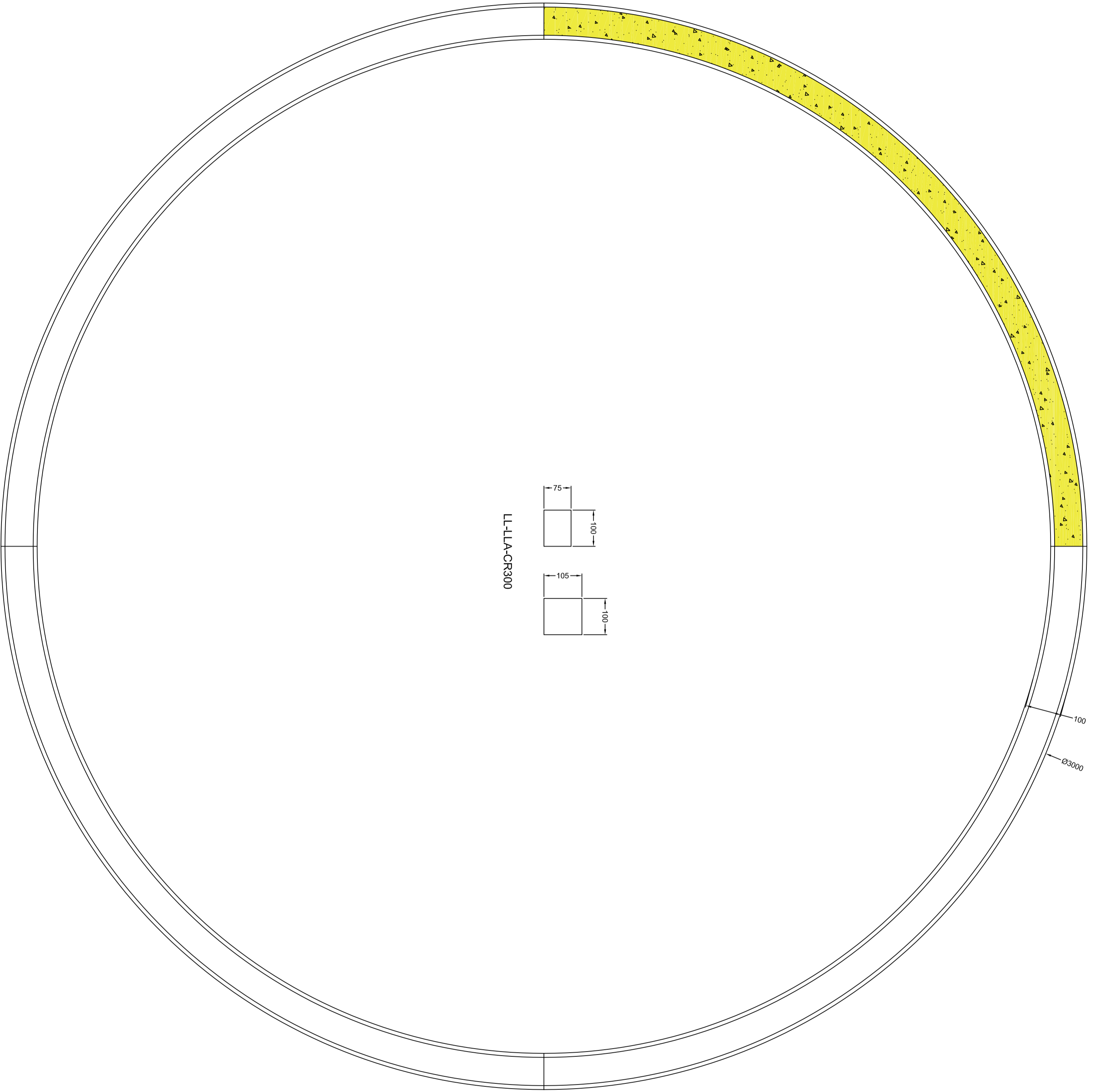

LL-LLA-CR300

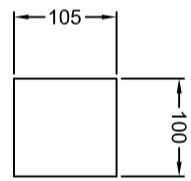
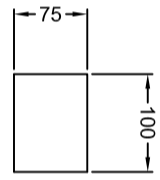

100

Ø3000

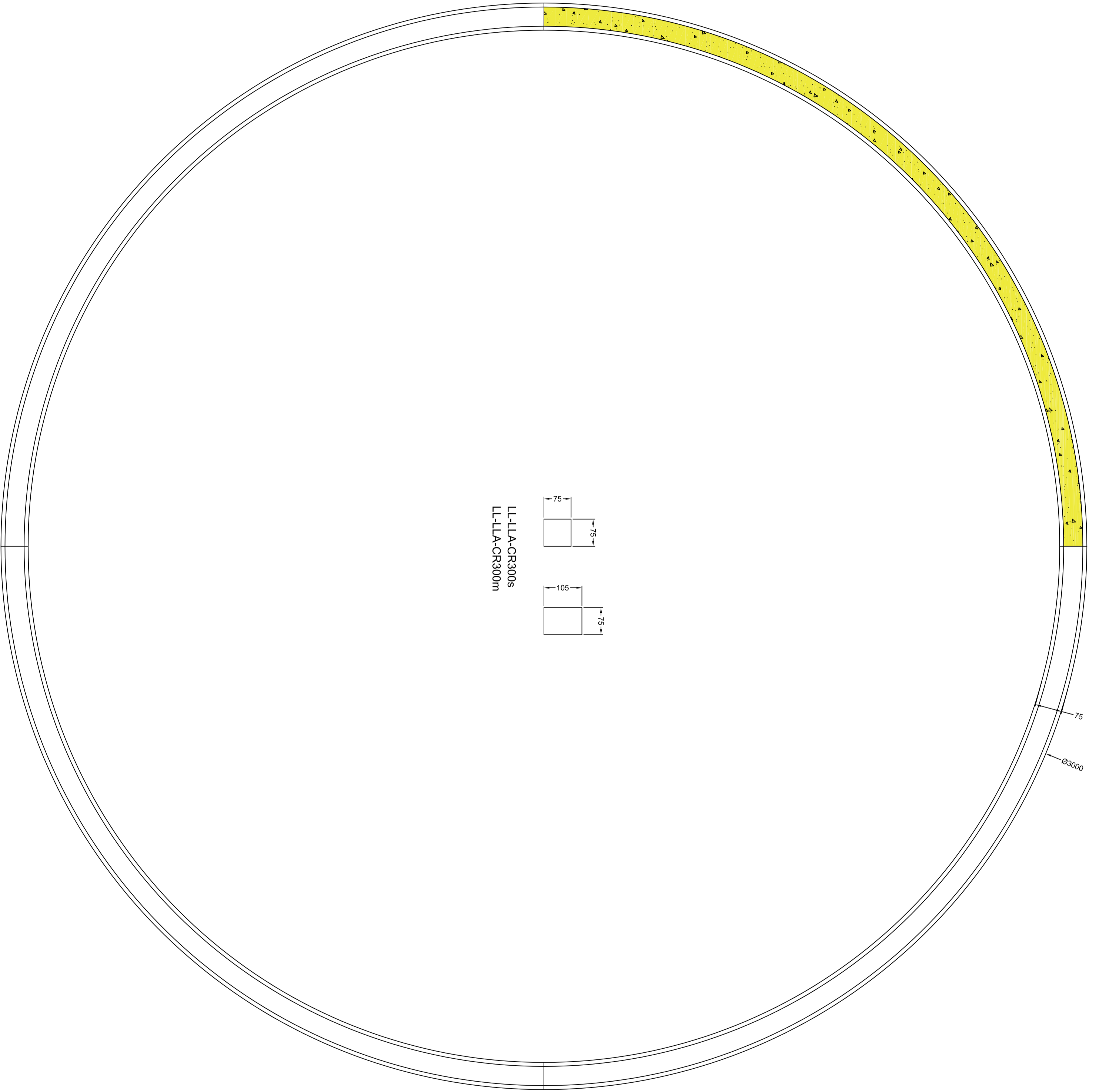

LL-LLA-CR300S  
LL-LLA-CR300m

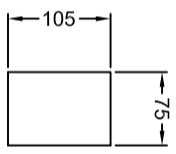
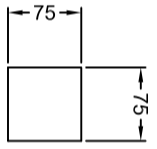

75  
Ø3000

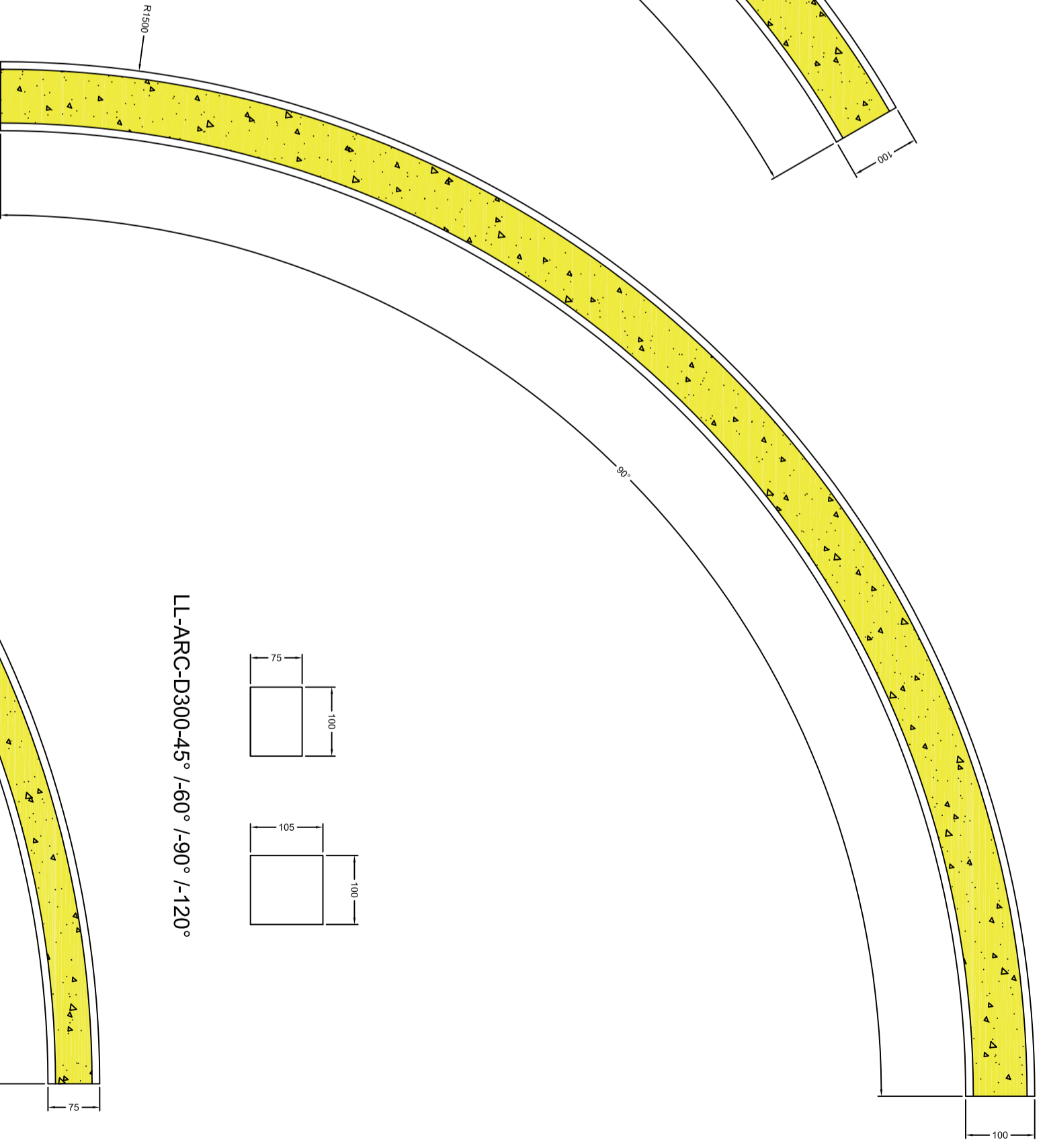
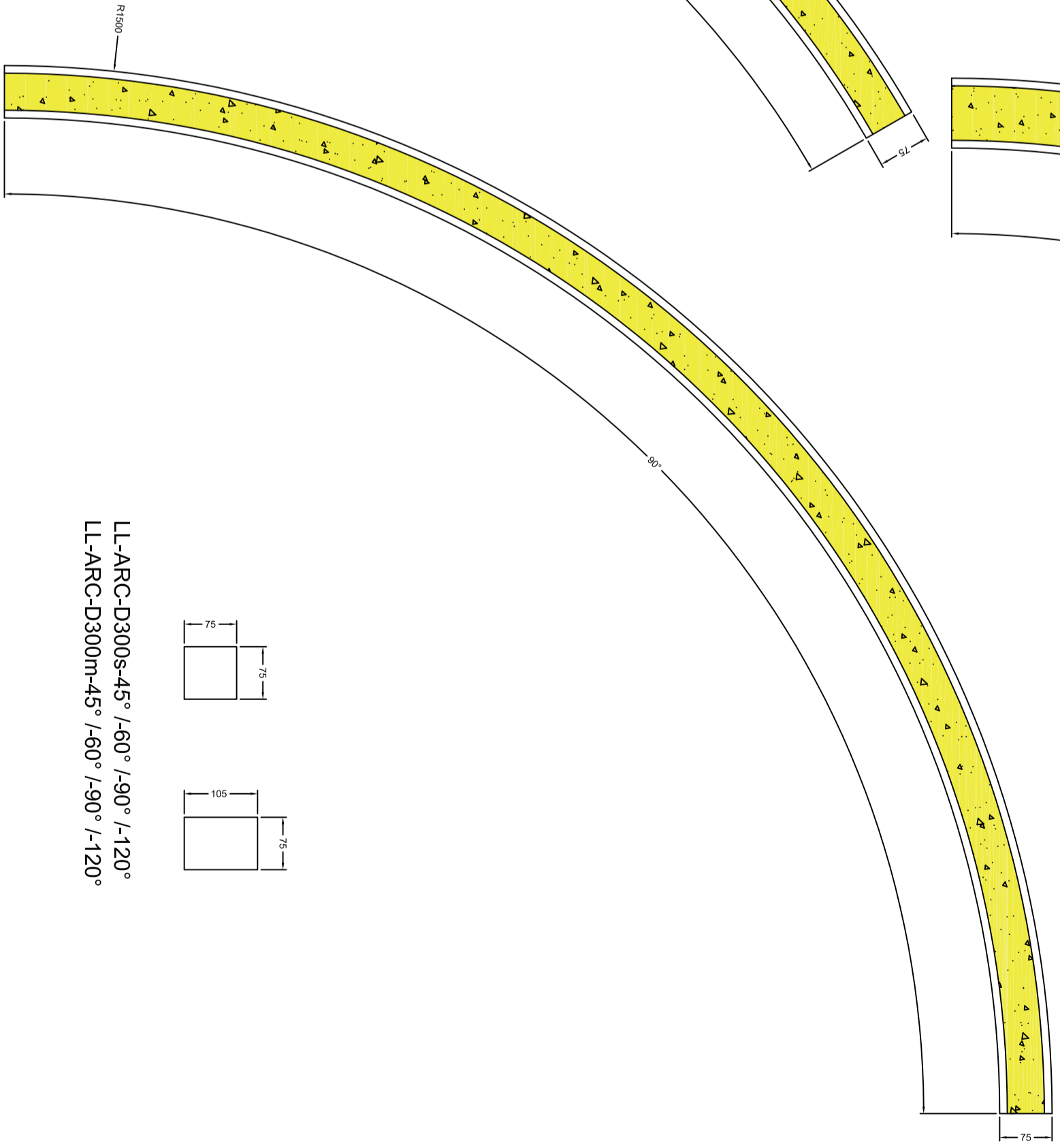
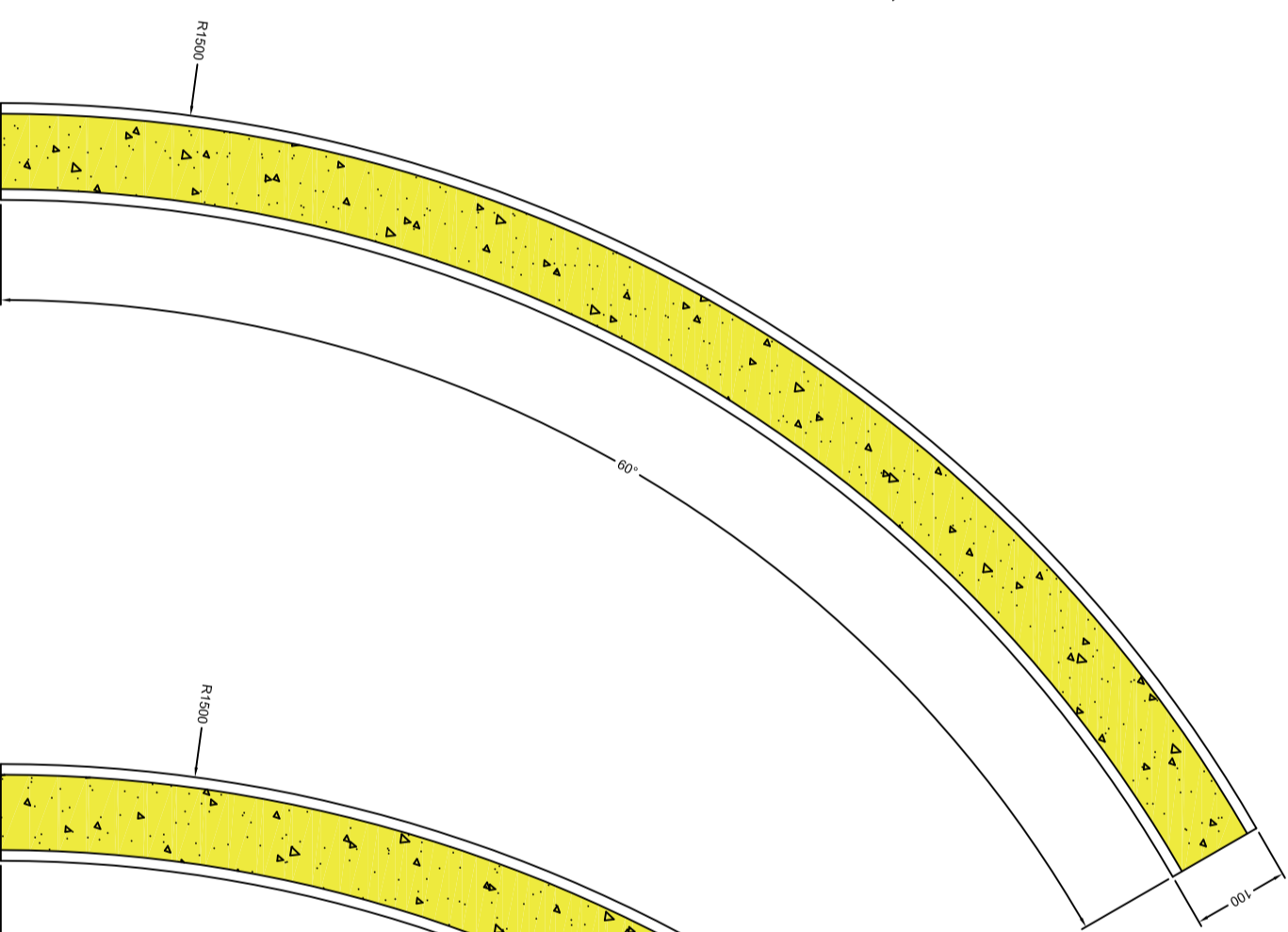
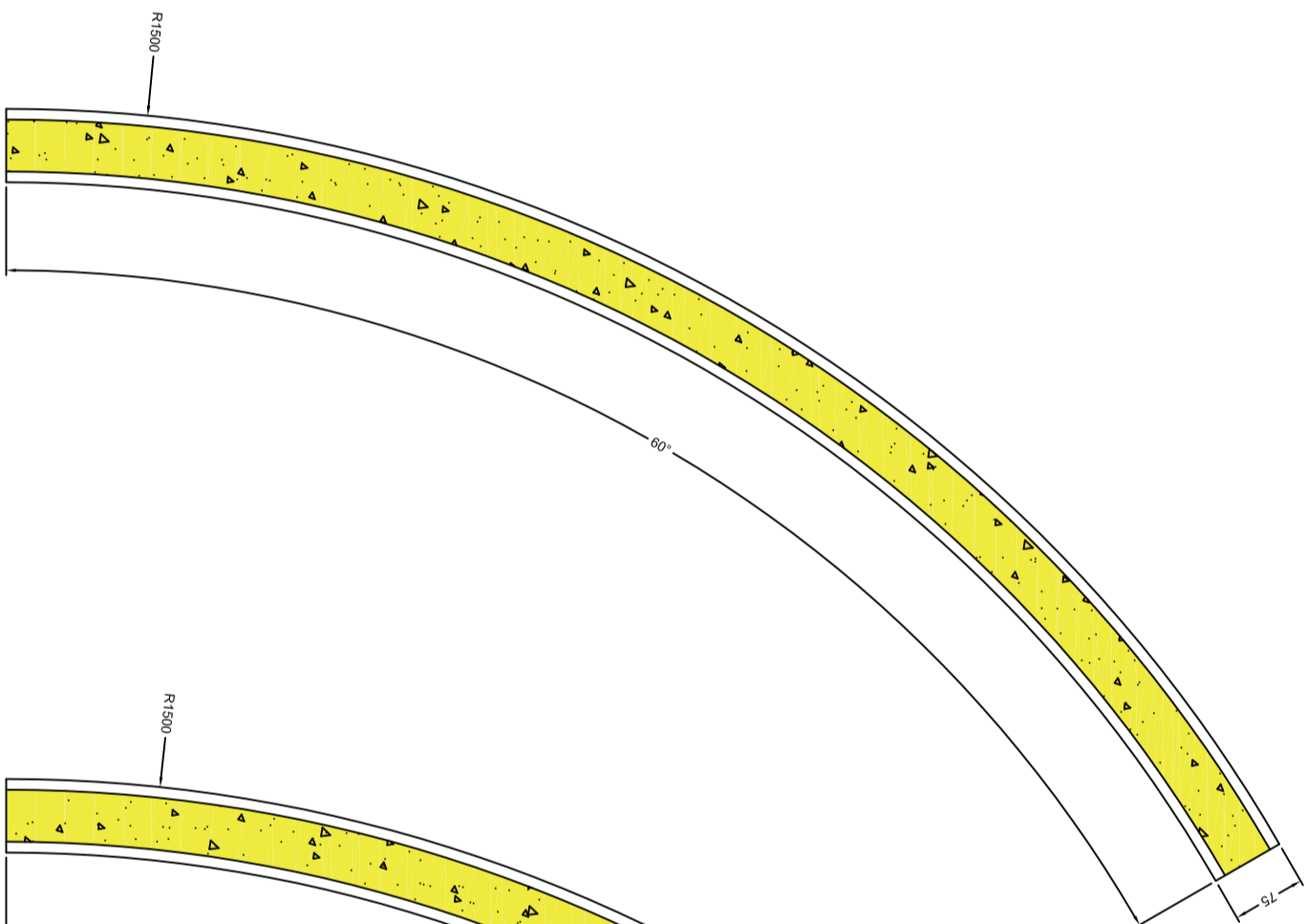
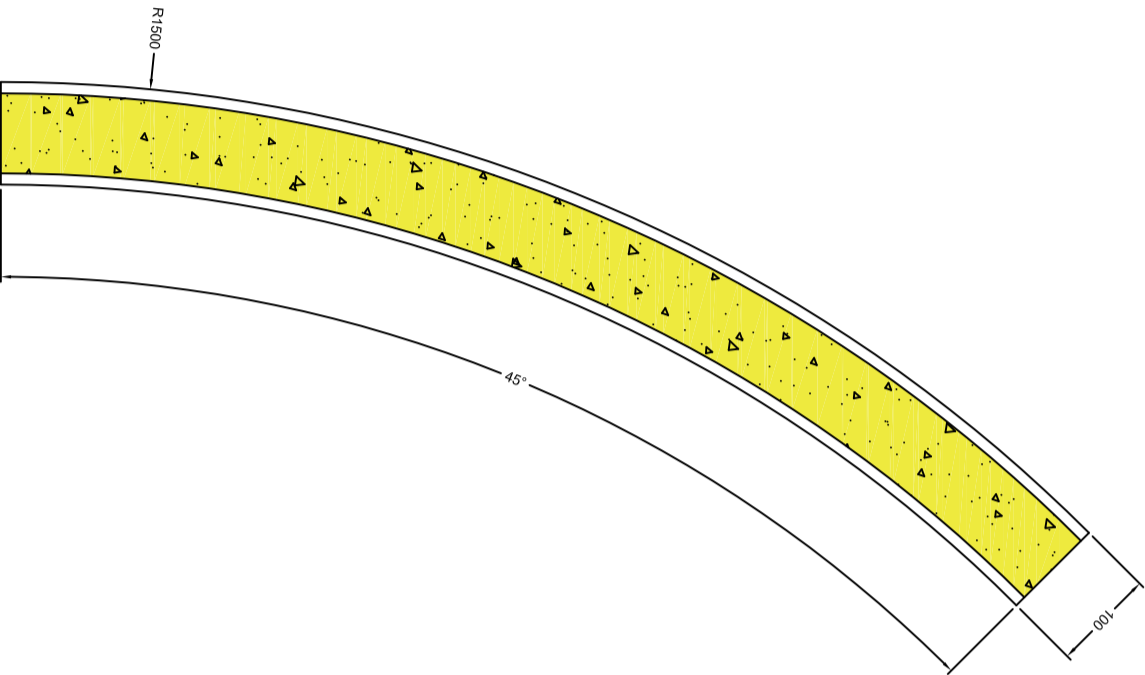
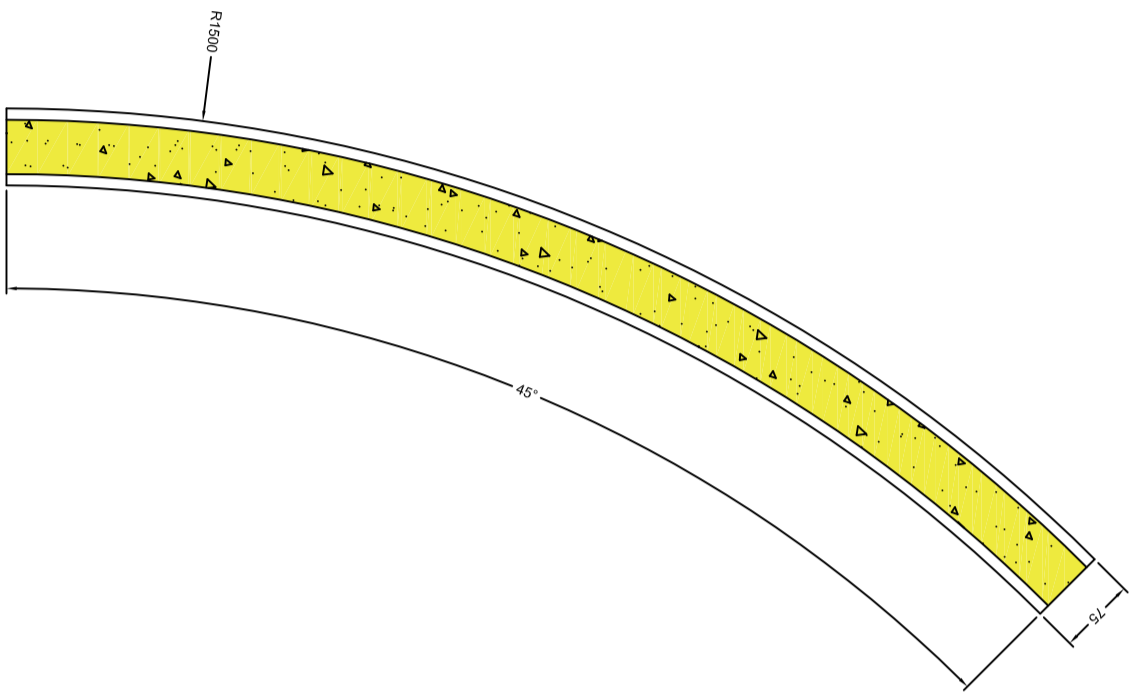
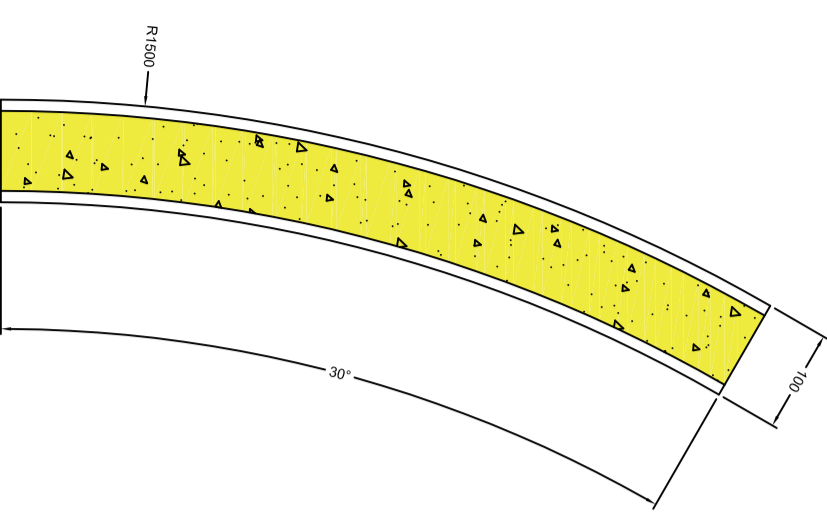
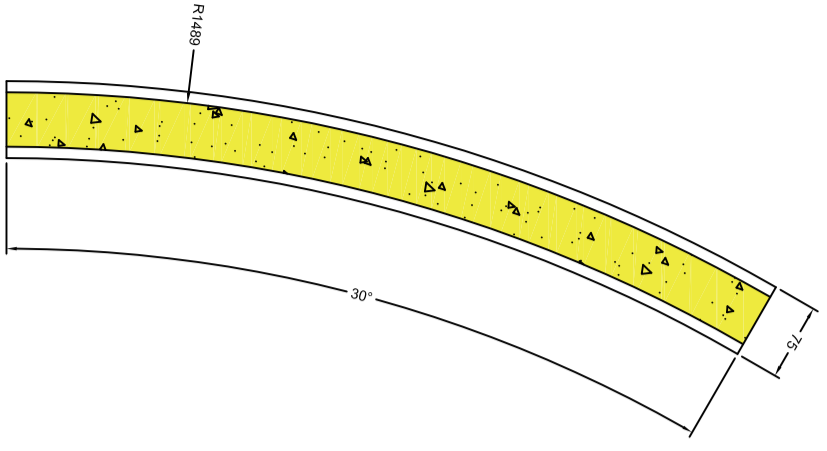

LL-ARC-D300s-45° /-60° /-90° /-120°  
 LL-ARC-D300m-45° /-60° /-90° /-120°

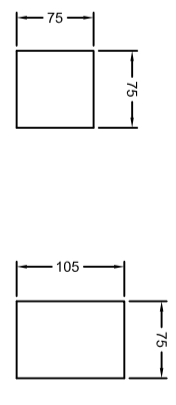

LL-ARC-D300-45° /-60° /-90° /-120°

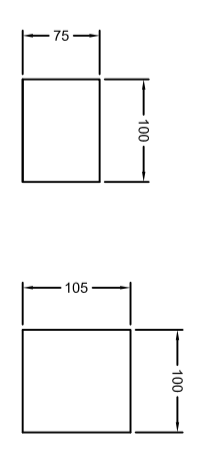



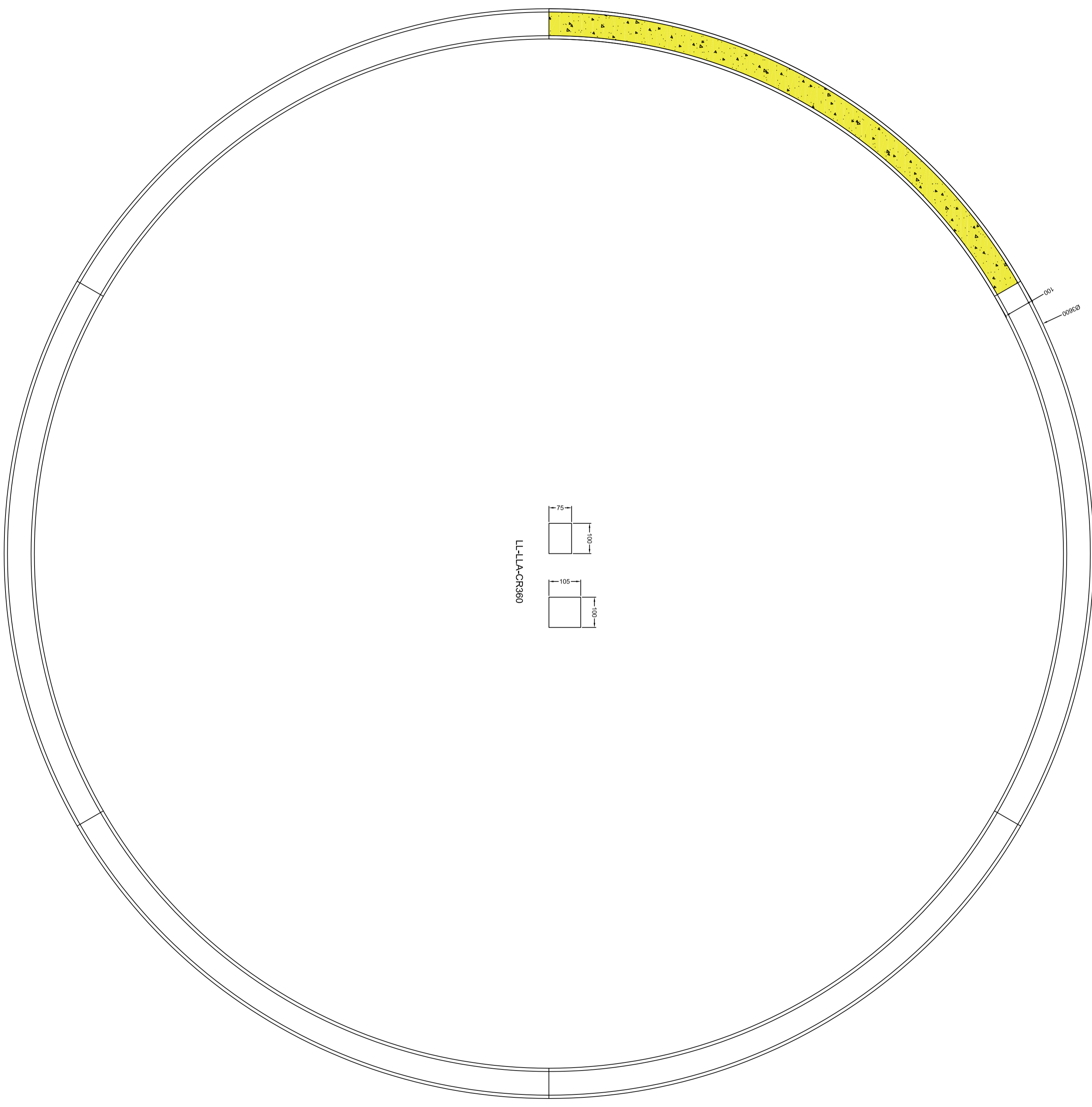

LI-LLA-CR360

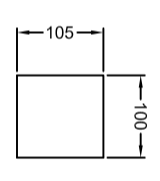
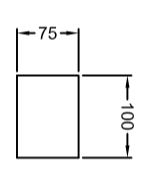



L1-L1A-CR360S  
L1-L1A-CR360m

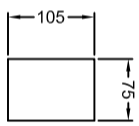
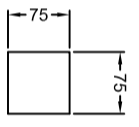



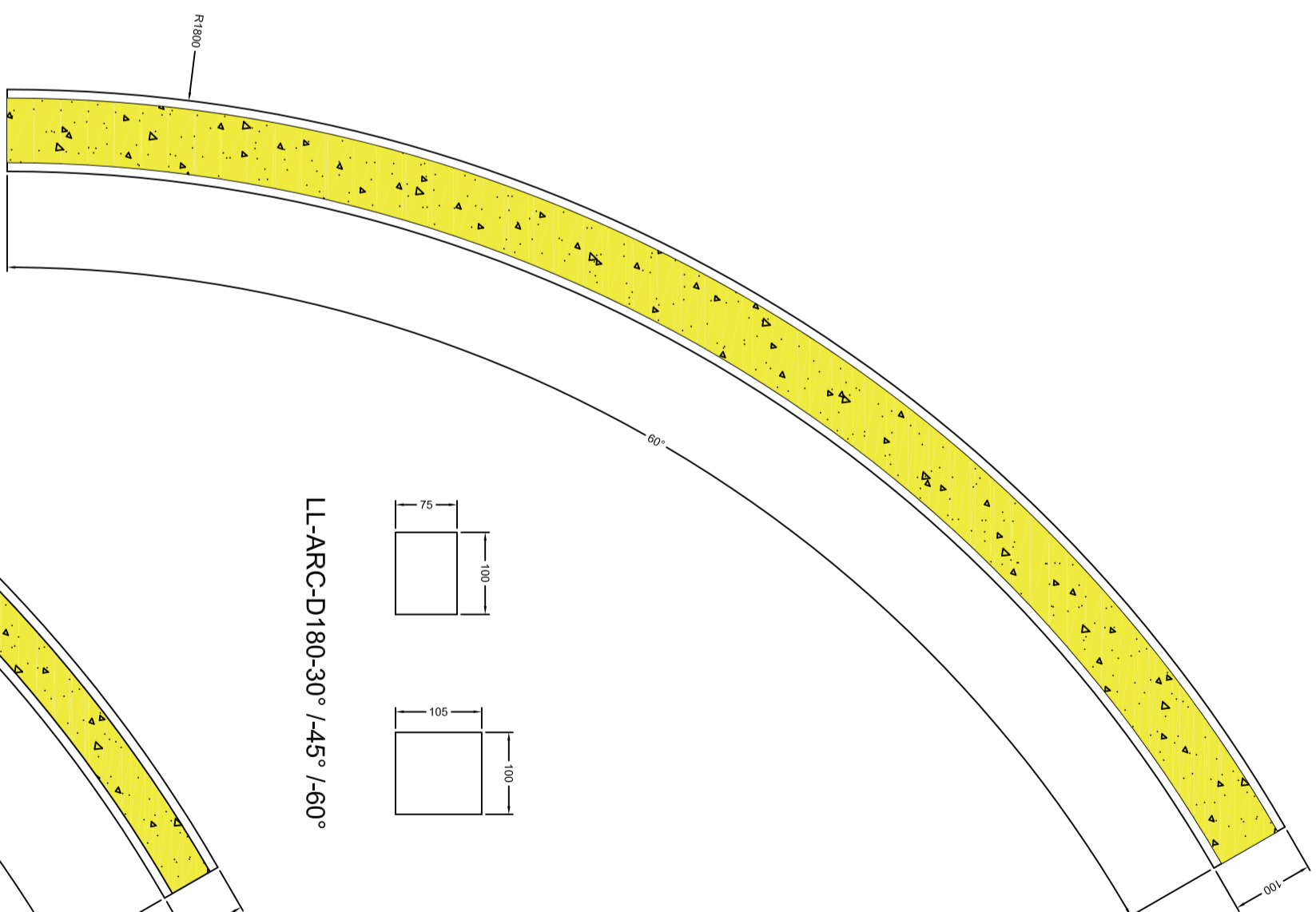
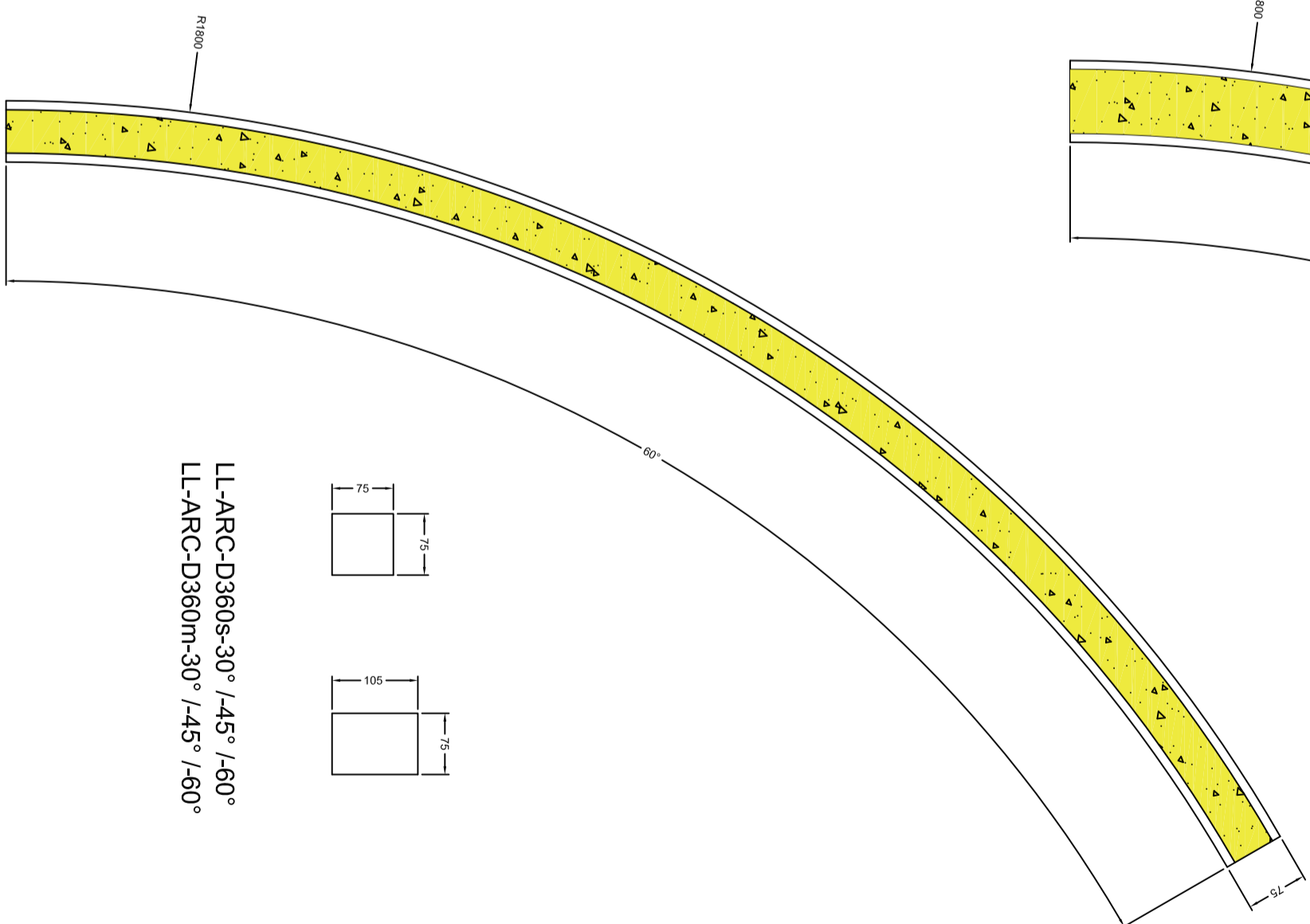
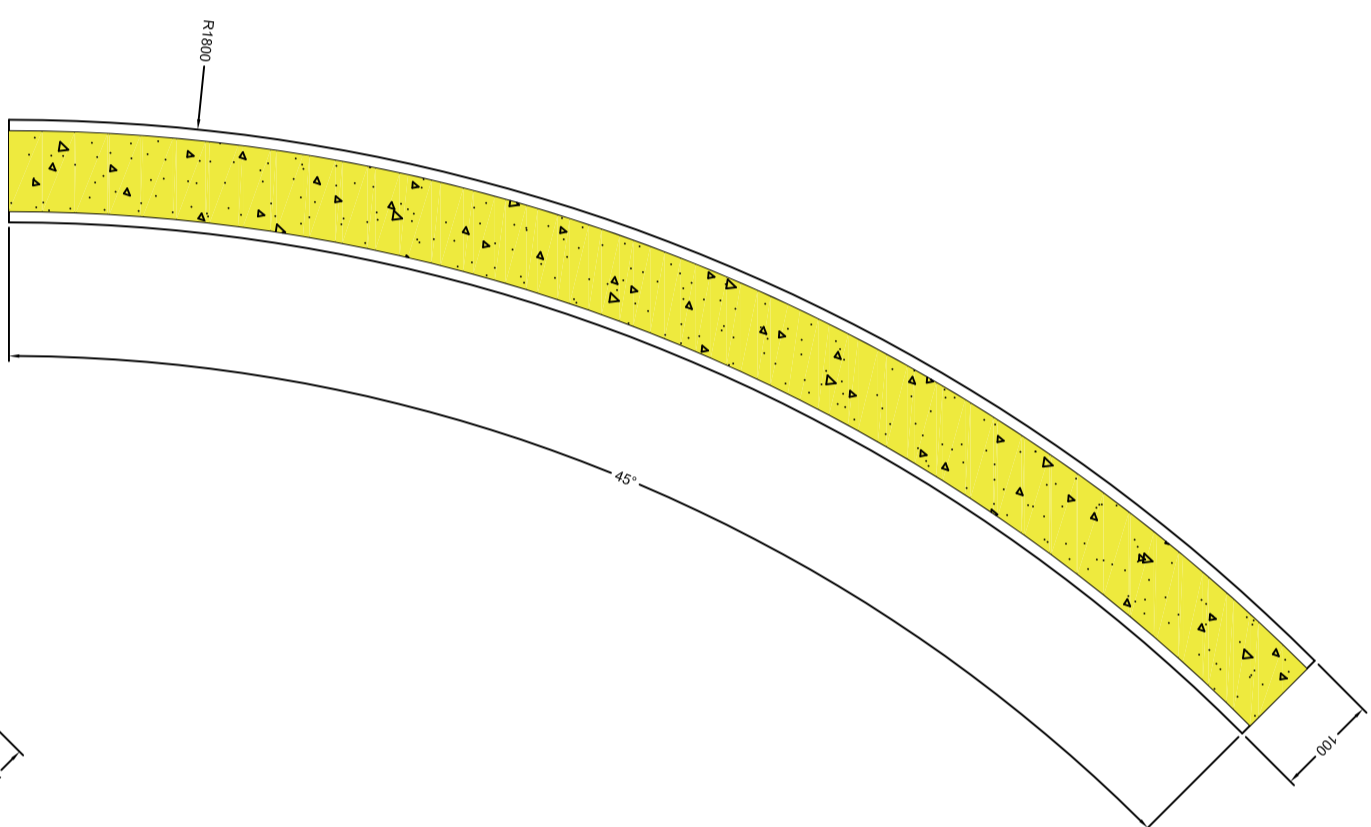
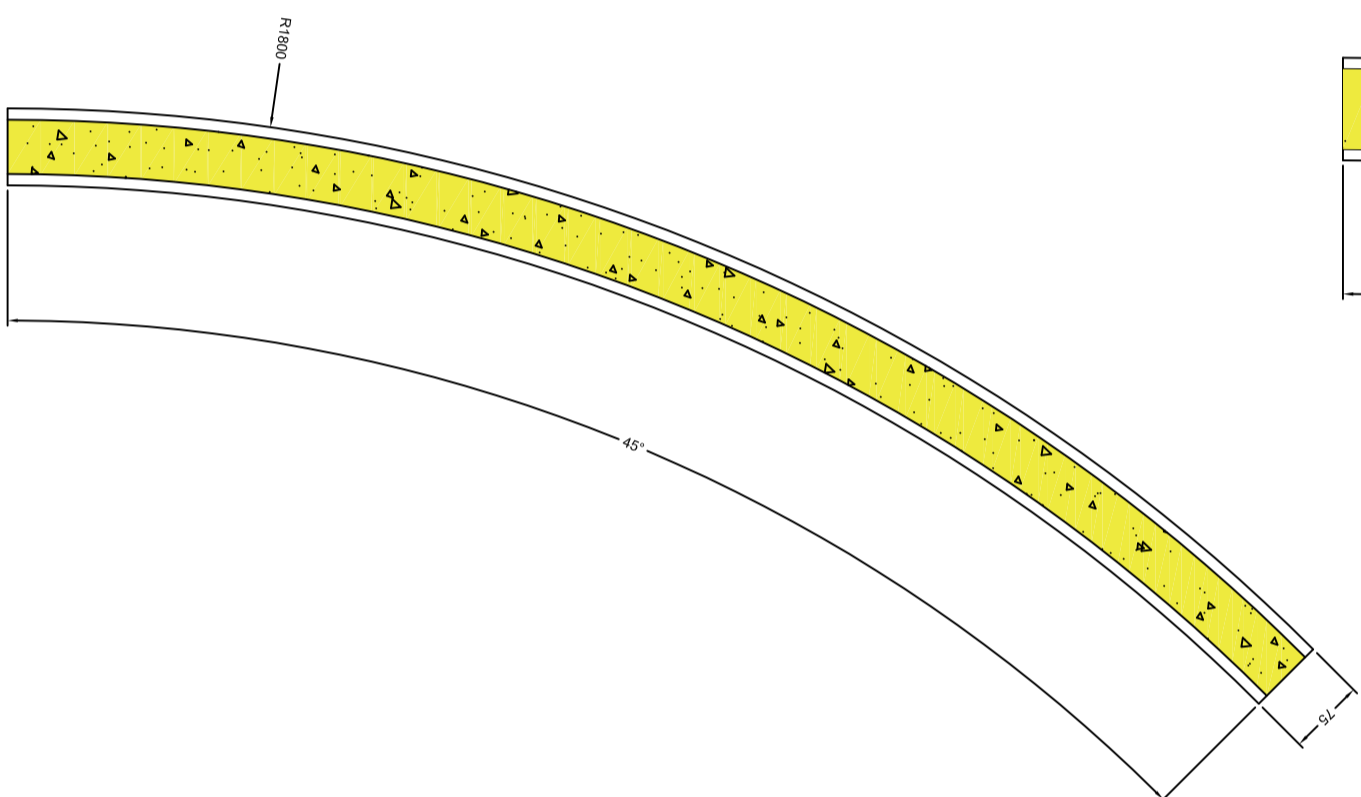
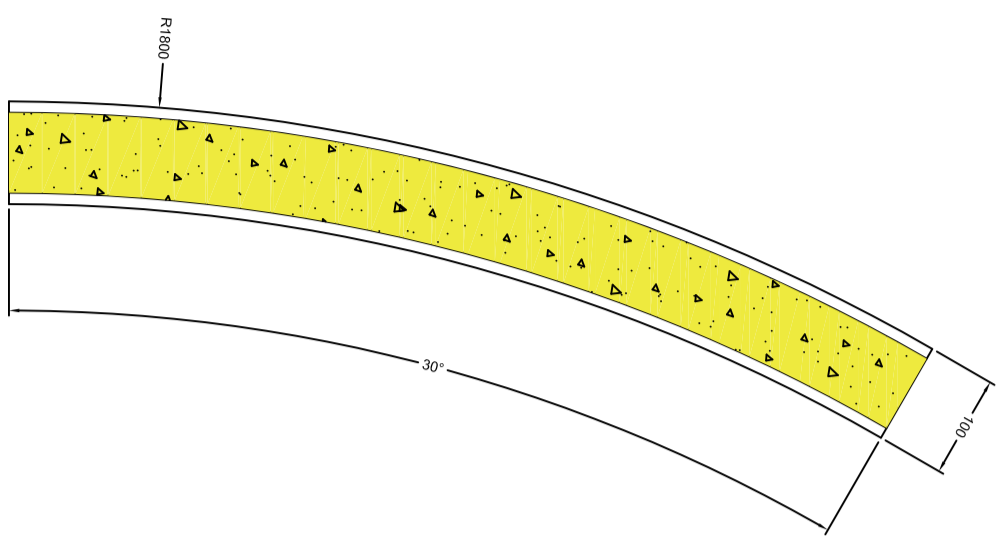
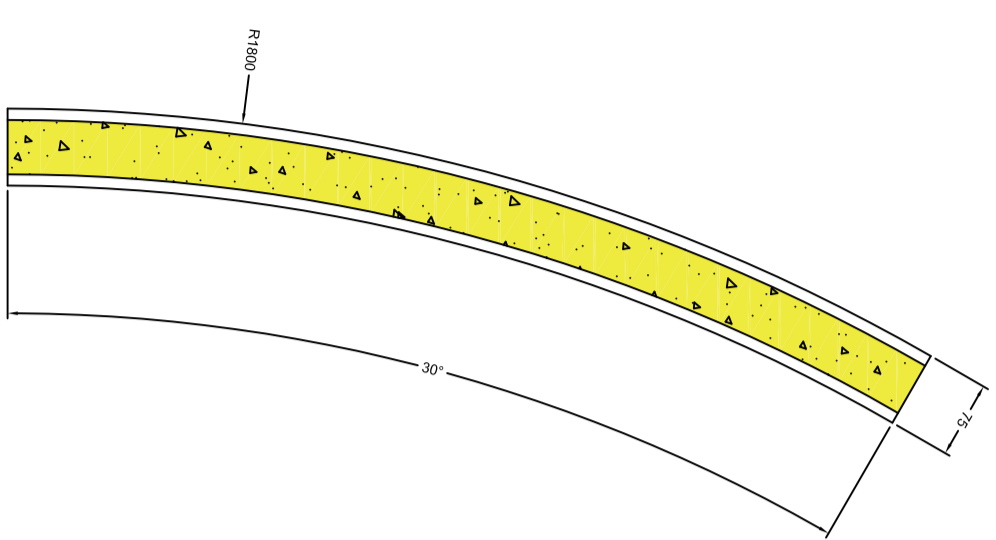

LL-ARC-D360s-30° / 45° / 60°  
 LL-ARC-D360m-30° / 45° / 60°

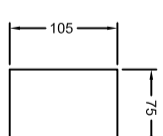
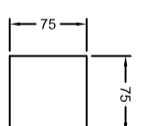

LL-ARC-D180-30° / 45° / 60°

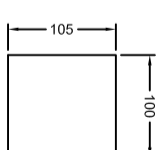
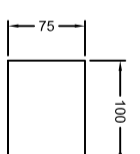

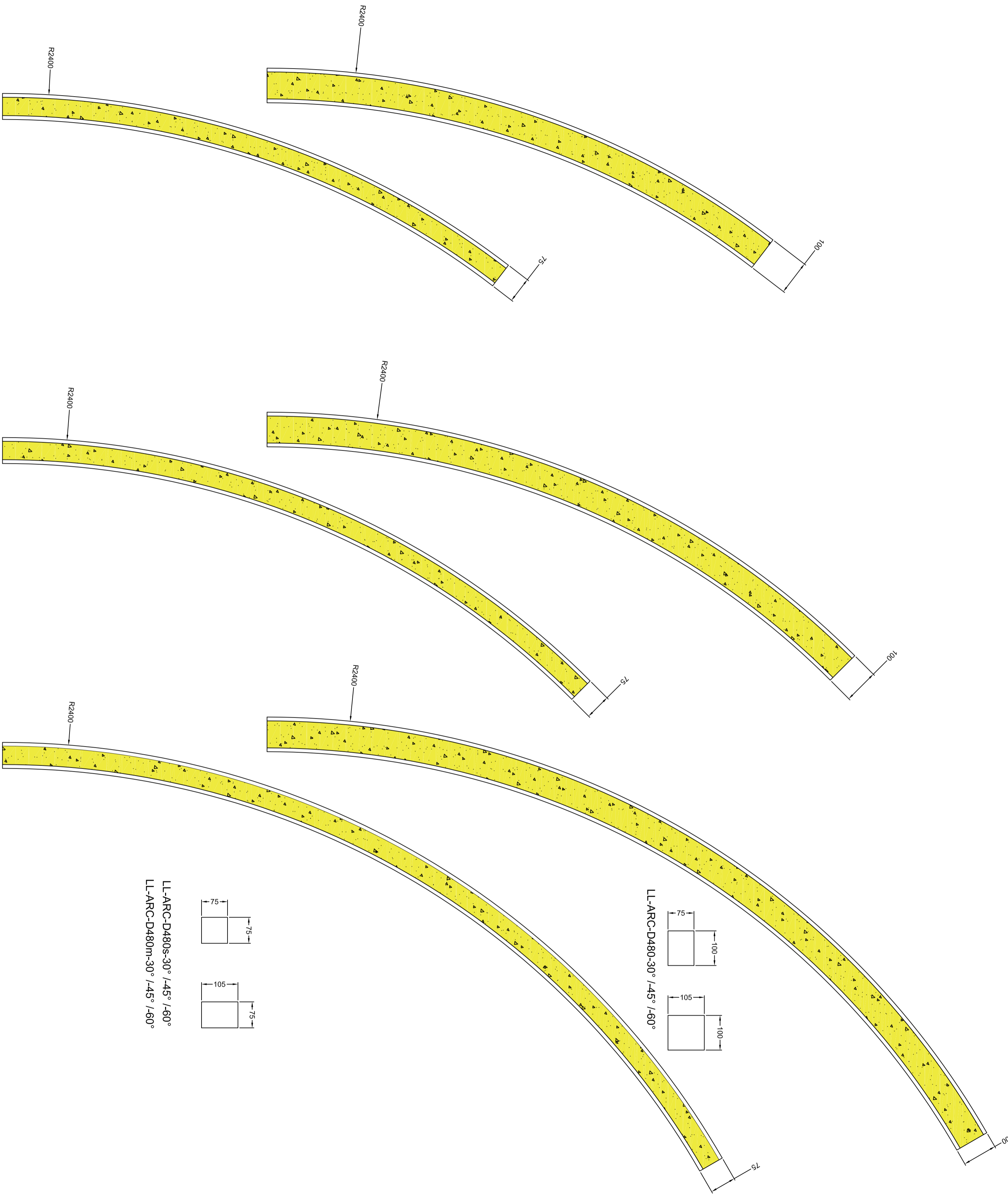

LL-ARC-D480S-30° /45° /60°  
 LL-ARC-D480m-30° /45° /60°

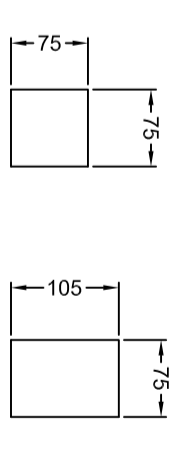

LL-ARC-D480-30° /45° /60°

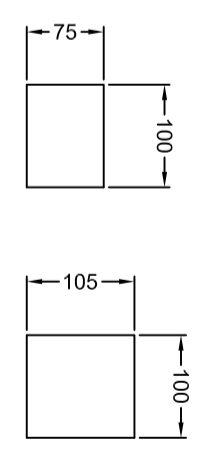



LL-LIACR380

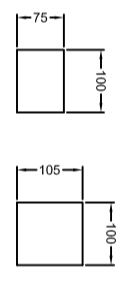



L-LLA-CR480S  
L-LLA-CR480m

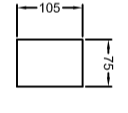
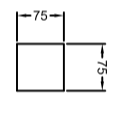

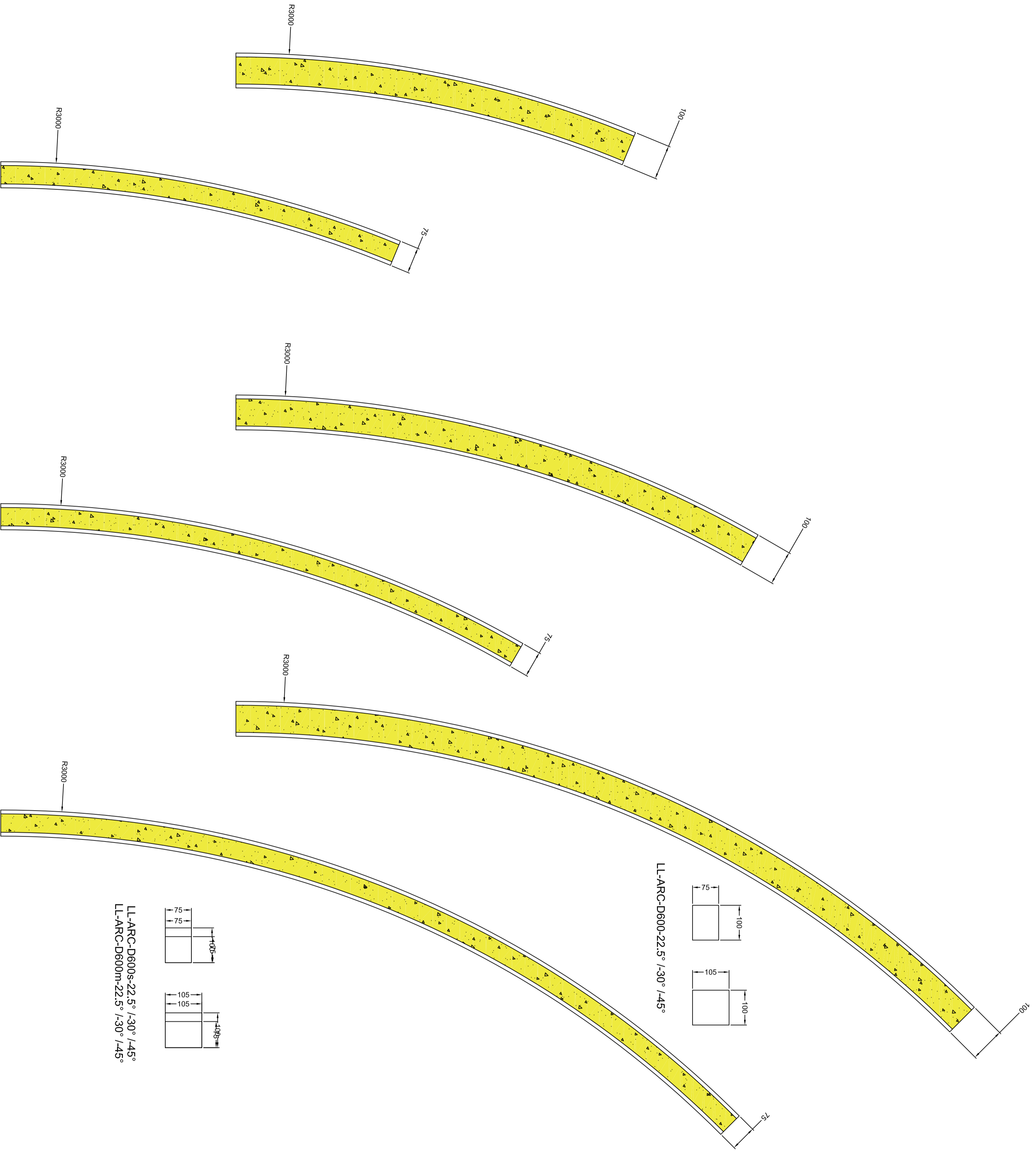

LL-ARC-D600-22.5° /-30° /45°

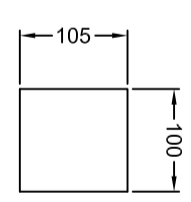
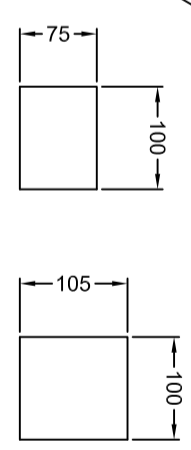

LL-ARC-D600s-22.5° /-30° /45°  
 LL-ARC-D600m-22.5° /-30° /45°

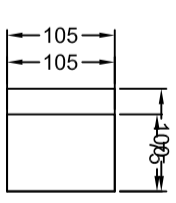
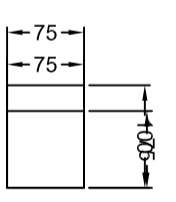





0025047111

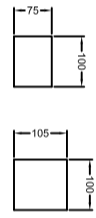



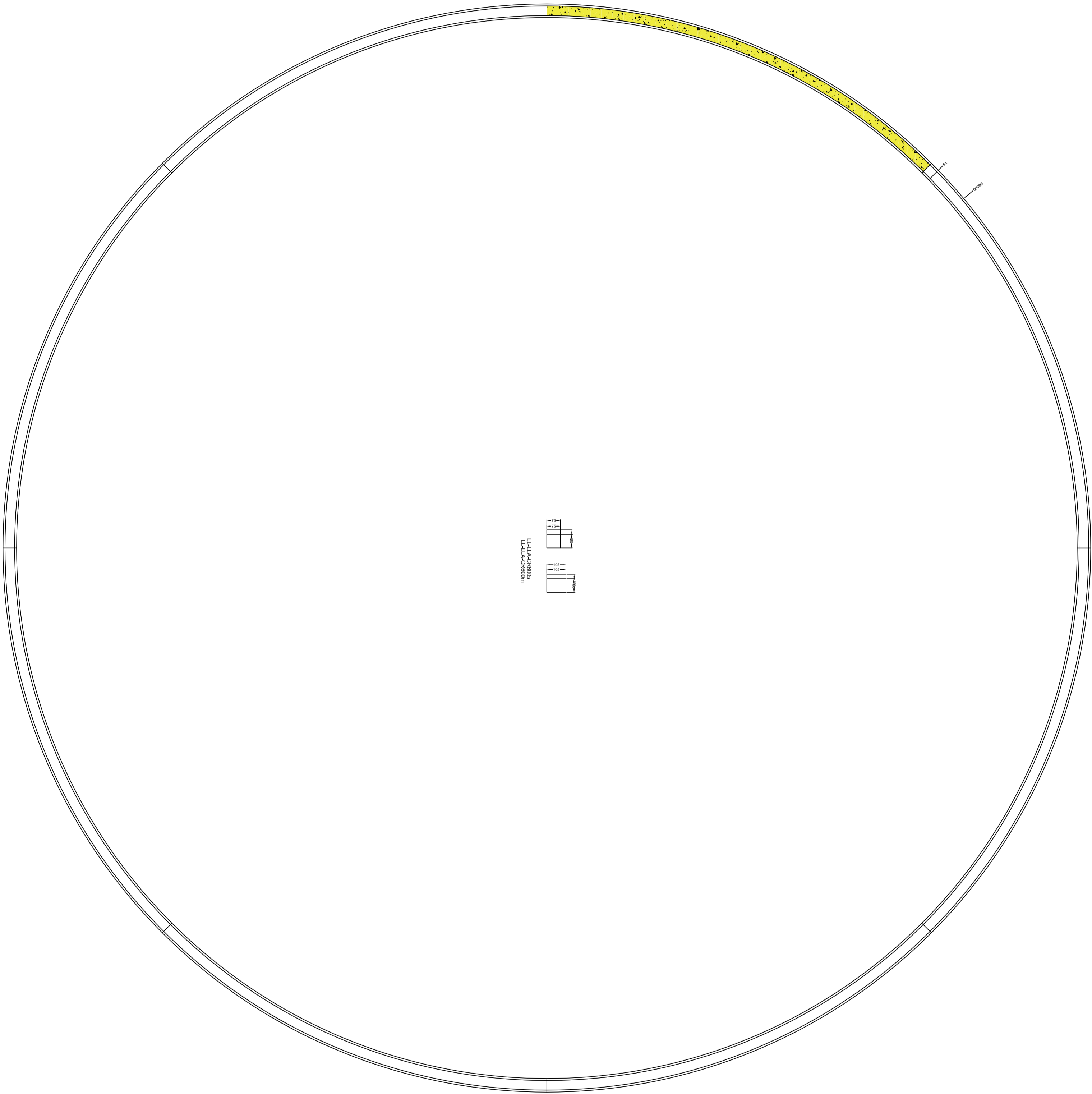

L1-L1A-C8000  
L1-L1A-C8000

