

**Power Inductor AKPx Series**

**Automotive  
AEC-Q200**

RoHS Compliant  
Halogen Free  
REACH Compliant



- Noise  
Suppression
- Shield
- Multilayer
- Ferrite
- General  
Signal line

**Part Numbering**

A	KPx	00	201610	1R0	M	00
Grade	Series Name	Control Code	Dimensions Code (mm)	Inductance (uH)	Tolerance	Internal Code
	KPB		1608DZ 1.6x0.8x0.8	R47 0.47	T ±30%	A2
	KPE		201210 2.0x1.25x1.0	1R0 1.0	M ±20%	A6
			201610 2.0x1.6x1.0			
			252010 2.5x2.0x1.0			

This specification applies to Multilayer Chip Inductors for Automotive Electronics based on AEC-Q200 except for Power train and Safety.

**Power Inductor AKPx Series**

**Automotive  
AEC-Q200**

**AKPB001608DZ Type**

**■ Dimensions**

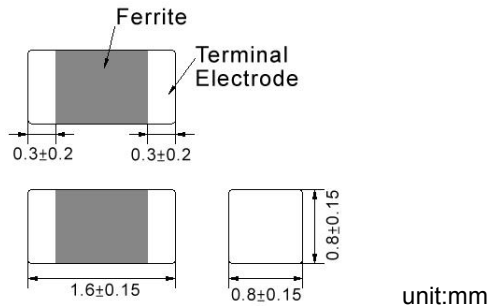

**■ Recommended Land Pattern**

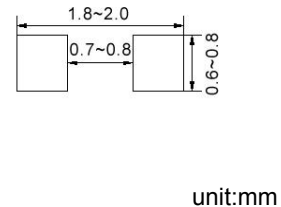

**■ Electrical Characteristics**

Part No.	Inductance	Test Freq.	RDC	Isat	Irms(mA)Max.		Tolerance
	(uH)				( $\Omega$ ) $\pm$ 30%	(mA)Max.	
AKPB001608DZR47□A2	0.47	3MHz,200mV	0.15	400	1100	800	20,30
AKPB001608DZ1R0□A2	1.0	3MHz,200mV	0.20	200	950	700	20,30
AKPB001608DZ2R2□A2	2.2	3MHz,200mV	0.30	150	750	550	20,30

**Note: When ordering, please specify tolerance code. Tolerance: M= $\pm$ 20% / T= $\pm$ 30%**

1. Operating temperature range - 40°C ~ 125°C
2. Isat for Inductance drop 30% from its value without current
3. Irms for When applied current to the Products, temperature rise caused by self-generated heat shall be limited to 40 °C max
4. As for the Rated current marked with \*1, Rated Current is depending on the operating temperature
5. Measure Equipment :  
 L : Agilent HP4287A+16197A  
 RDC : HP 4338B, or equivalent

**Power Inductor AKPx Series**

**Automotive  
AEC-Q200**

**AKPB001608DZ Type**

**Characteristics Graph**

**Inductance vs. Frequency Characteristics**

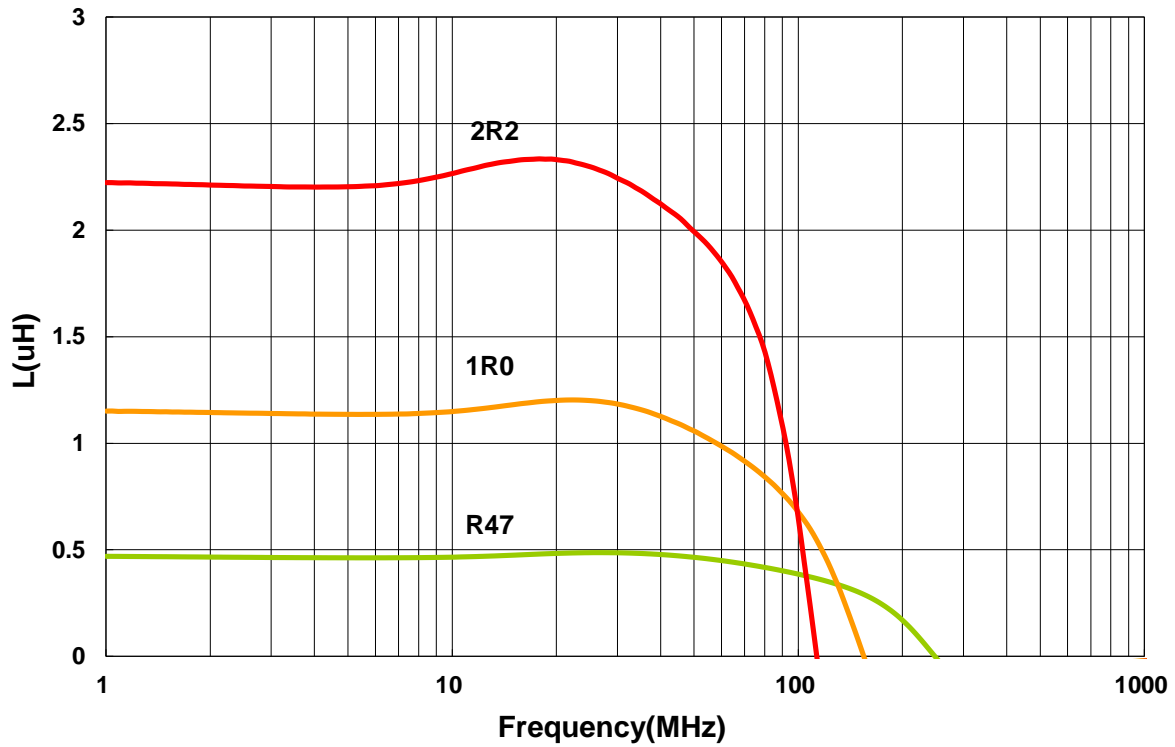

**Inductance vs. DC Current**

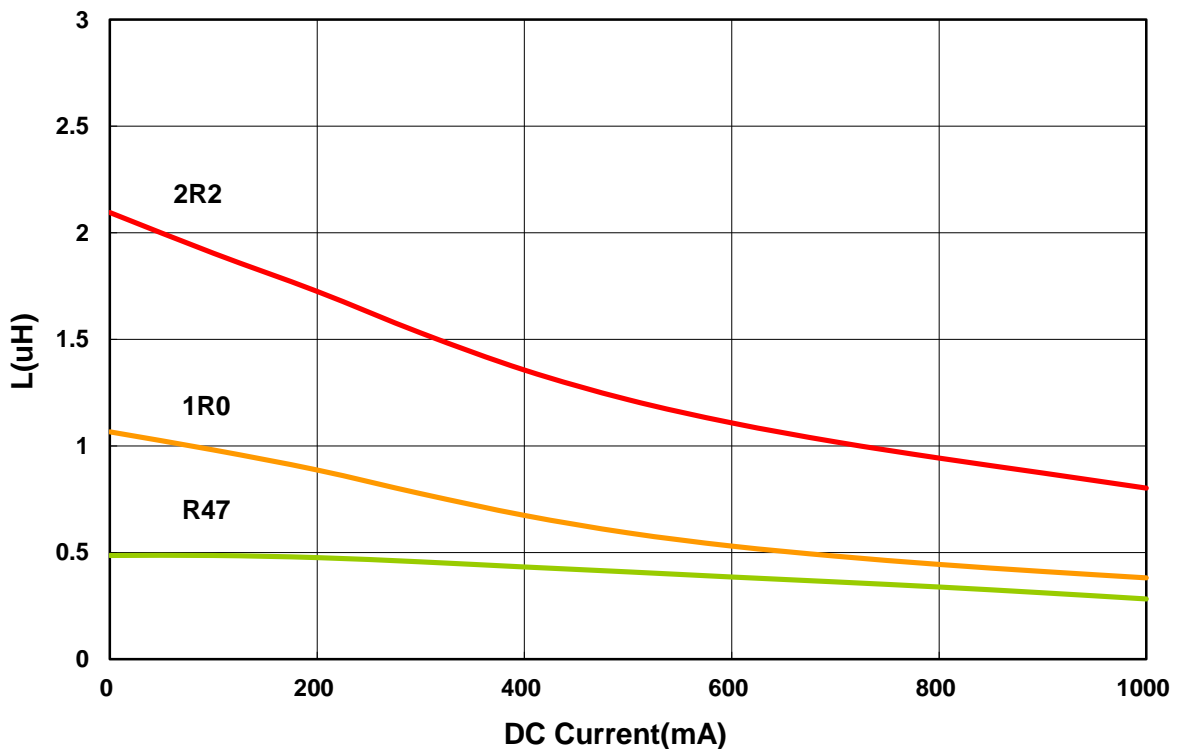

**Power Inductor AKPx Series**

**Automotive  
AEC-Q200**

**AKPB00201210 Type**

**■ Dimensions**

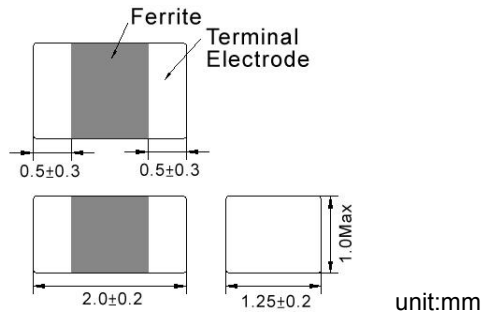

**■ Recommended Land Pattern**

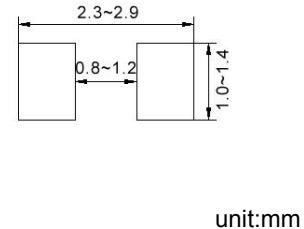

**■ Electrical Characteristics**

Part No.	Inductance	Test Freq.	RDC	Isat	Irms(mA)Max.		Tolerance
	(uH)				( $\Omega$ ) $\pm$ 30%	(mA)Max.	
AKPB00201210R47□A2	0.47	3MHz,200mV	0.09	1100	1300	950	20,30
AKPB002012101R0□A2	1.0	3MHz,200mV	0.12	650	1200	900	20,30
AKPB002012101R5□A2	1.5	3MHz,200mV	0.15	450	1100	800	20,30
AKPB002012102R2□A2	2.2	3MHz,200mV	0.19	400	1100	800	20,30
AKPB002012103R3□A2	3.3	3MHz,200mV	0.24	300	800	600	20,30
AKPB002012104R7□A2	4.7	3MHz,200mV	0.26	200	700	500	20,30

**Note: When ordering, please specify tolerance code. Tolerance: M= $\pm$ 20% / T= $\pm$ 30%**

1. Operating temperature range - 40°C ~ 125°C
2. Isat for Inductance drop 30% from its value without current
3. Irms for When applied current to the Products, temperature rise caused by self-generated heat shall be limited to 40 °C max
4. As for the Rated current marked with \*1, Rated Current is depending on the operating temperature
5. Measure Equipment :  
L : Agilent HP4287A+16197A  
RDC : HP 4338B, or equivalent

**Power Inductor AKPx Series**

**Automotive  
AEC-Q200**

**AKPB00201210 Type**

**Characteristics Graph**

**Inductance vs. Frequency Characteristics**

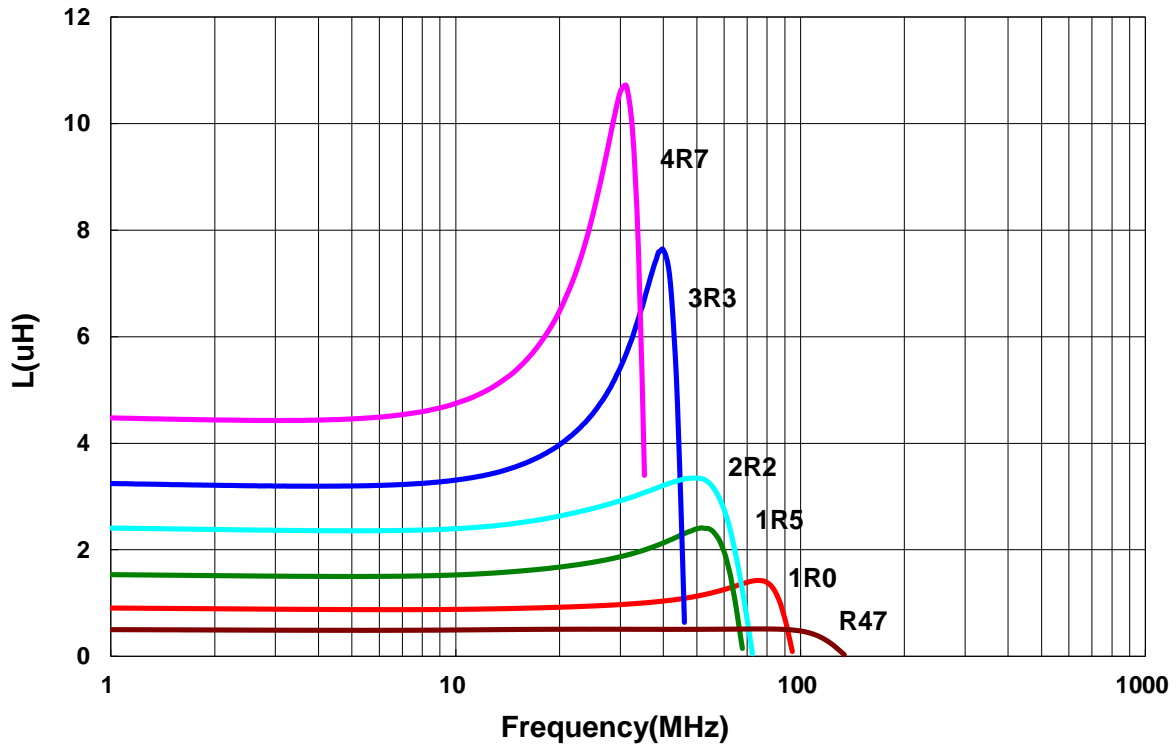

**Inductance vs. DC Current**

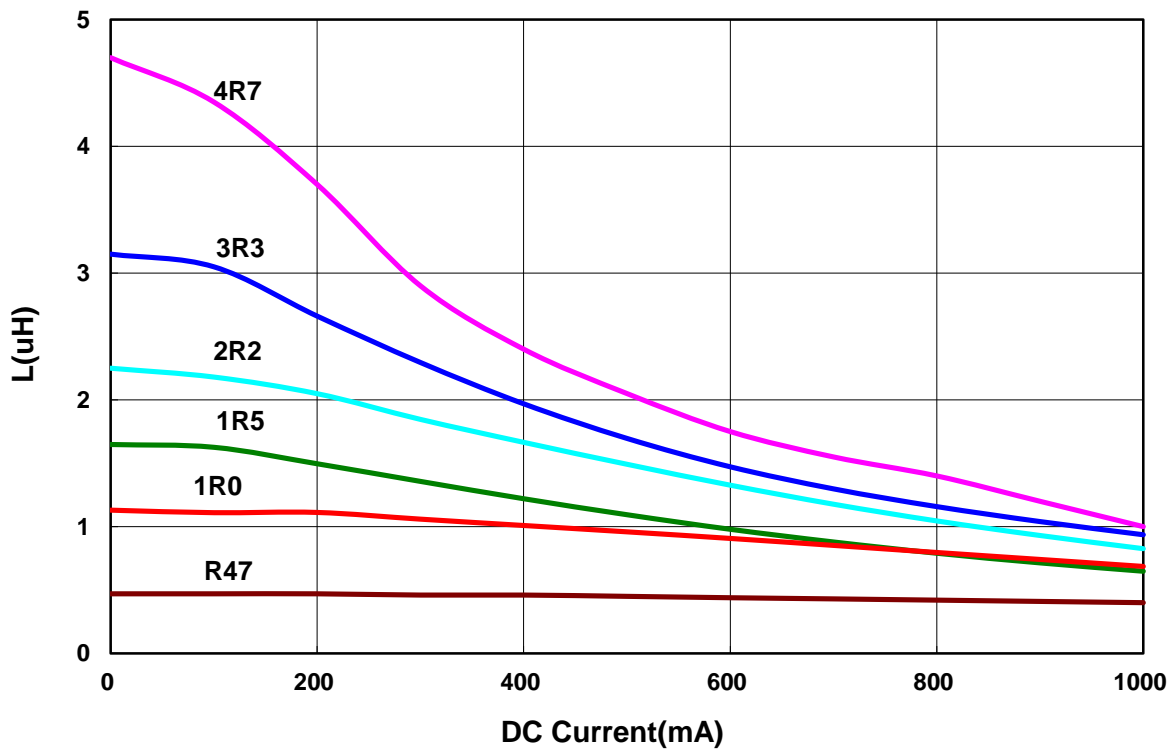

**Power Inductor AKPx Series**

**Automotive  
AEC-Q200**

**AKPB00201610 Type**

**■ Dimensions**

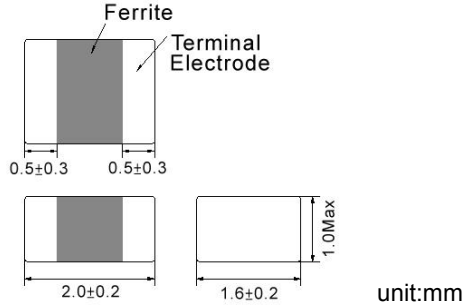

**■ Recommended Land Pattern**

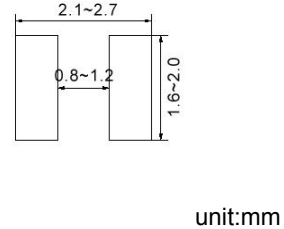

**■ Electrical Characteristics**

Part No.	Inductance	Test Freq.	RDC	Isat	Irms(mA)Max.		Tolerance
	(uH)				( $\Omega$ ) $\pm$ 25%	(mA)Max.	
AKPB00201610R47□A6	0.47	3MHz,200mV	0.06	1200	1600	1200	20,30
AKPB002016101R0□A6	1.0	3MHz,200mV	0.09	850	1300	950	20,30
AKPB002016101R5□A6	1.5	3MHz,200mV	0.11	600	1200	900	20,30
AKPB002016102R2□A6	2.2	3MHz,200mV	0.11	400	1200	900	20,30
AKPB002016103R3□A6	3.3	3MHz,200mV	0.12	350	850	625	20,30
AKPB002016104R7□A6	4.7	3MHz,200mV	0.14	200	1100	800	20,30

**Note: When ordering, please specify tolerance code. Tolerance: M= $\pm$ 20% / T= $\pm$ 30%**

1. Operating temperature range - 40°C ~ 125°C
2. Isat for Inductance drop 30% from its value without current
3. Irms for When applied current to the Products, temperature rise caused by self-generated heat shall be limited to 40 °C max
4. As for the Rated current marked with \*1, Rated Current is depending on the operating temperature
5. Measure Equipment :  
L : Agilent HP4287A+16197A  
RDC : HP 4338B, or equivalent

**Power Inductor AKPx Series**

**Automotive  
AEC-Q200**

**AKPB00201610 Type**

**Characteristics Graph**

**Inductance vs. Frequency Characteristics**

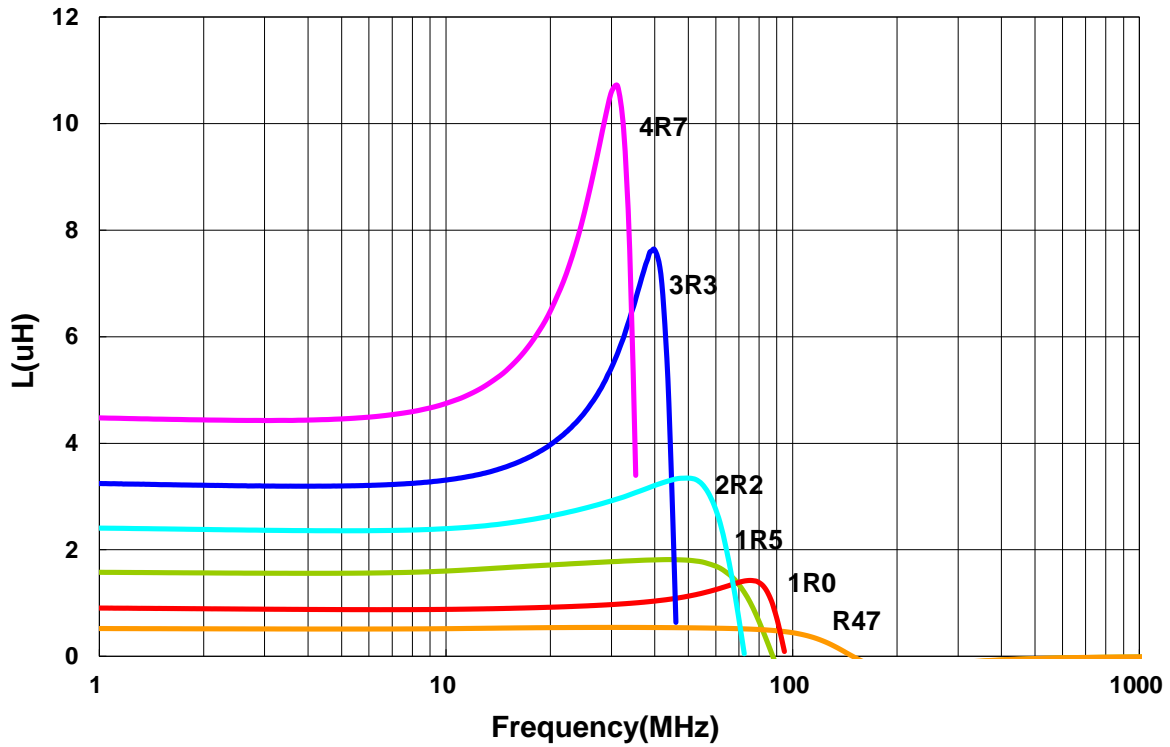

**Inductance vs. DC Current**

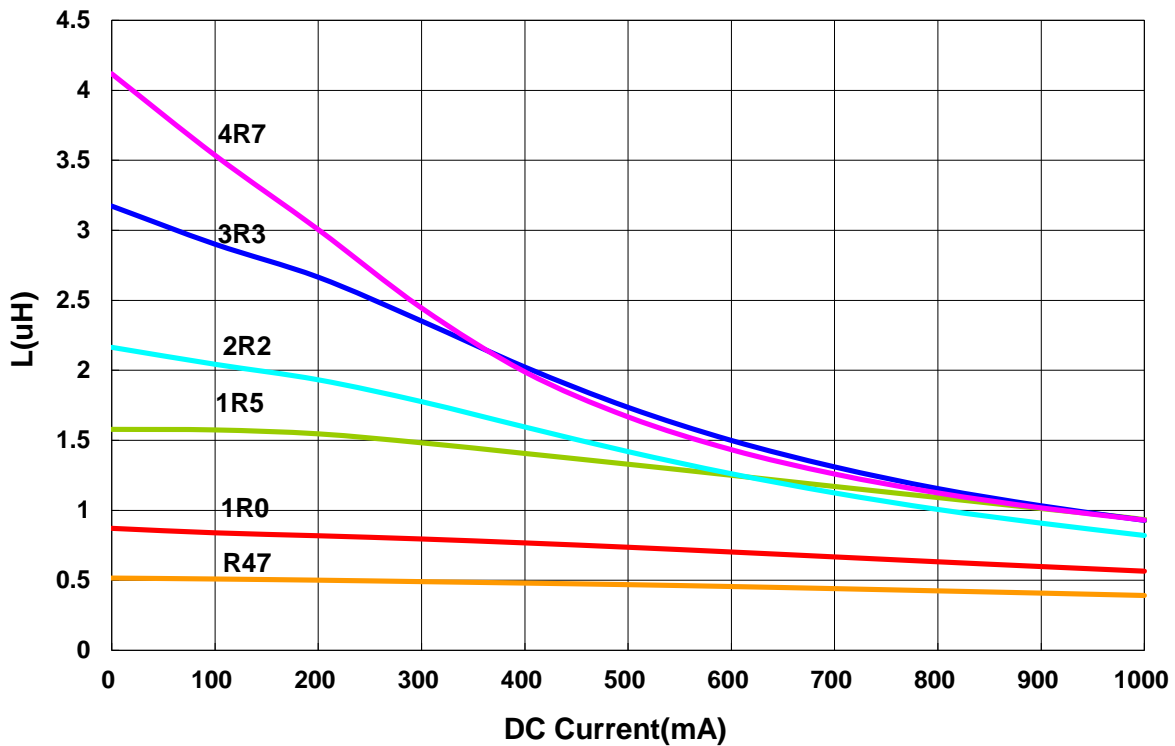

**Power Inductor AKPx Series**

**Automotive  
AEC-Q200**

**AKPB00252010 Type**

**■ Dimensions**

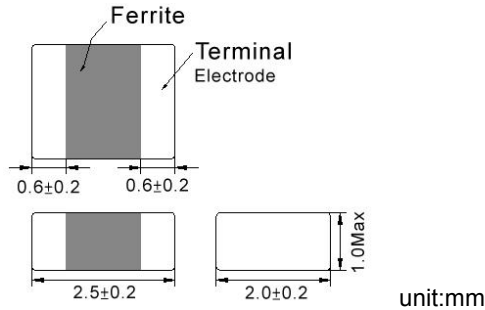

**■ Recommended Land Pattern**

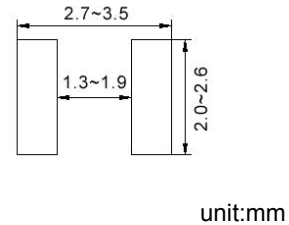

**■ Electrical Characteristics**

Part No.	Inductance	Test Freq.	RDC	Isat	Irms(mA)Max.		Tolerance
	(uH)				(Ω)±25%	(mA)Max.	
AKPB00252010R47□A6	0.47	3MHz,200mV	0.040	1500	1800	1300	20,30
AKPB002520101R0□A6	1.0	3MHz,200mV	0.055	900	1600	1200	20,30
AKPB002520102R2□A6	2.2	3MHz,200mV	0.080	500	1300	950	20,30
AKPB002520103R3□A6	3.3	3MHz,200mV	0.100	400	1200	900	20,30
AKPB002520104R7□A6	4.7	3MHz,200mV	0.110	300	1100	800	20,30

**Note: When ordering, please specify tolerance code. Tolerance: M=±20% / T=±30%**

1. Operating temperature range - 40°C ~ 125°C
2. Isat for Inductance drop 30% from its value without current
3. Irms for When applied current to the Products, temperature rise caused by self-generated heat shall be limited to 40 °C max
4. As for the Rated current marked with \*1, Rated Current is depending on the operating temperature
5. Measure Equipment :  
L : Agilent HP4287A+16197A  
RDC : HP 4338B, or equivalent



AKPB00252010 Type

■ Characteristics Graph

Inductance vs. Frequency Characteristics

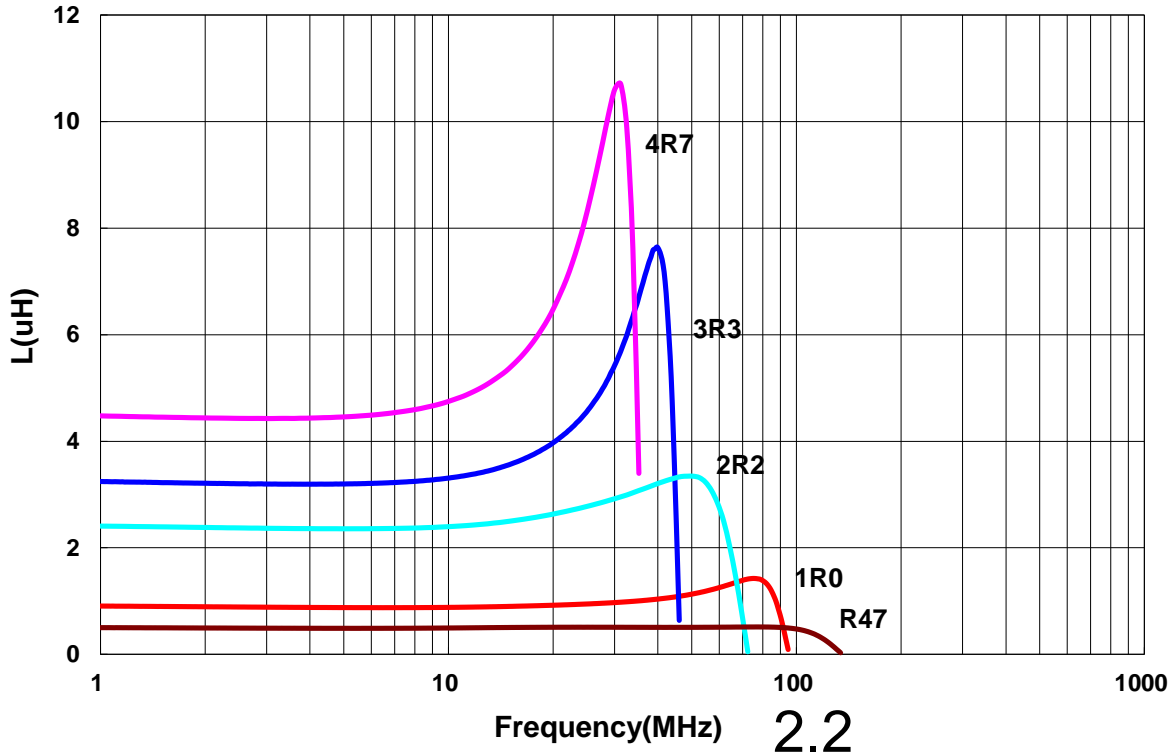

Inductance vs. DC Current

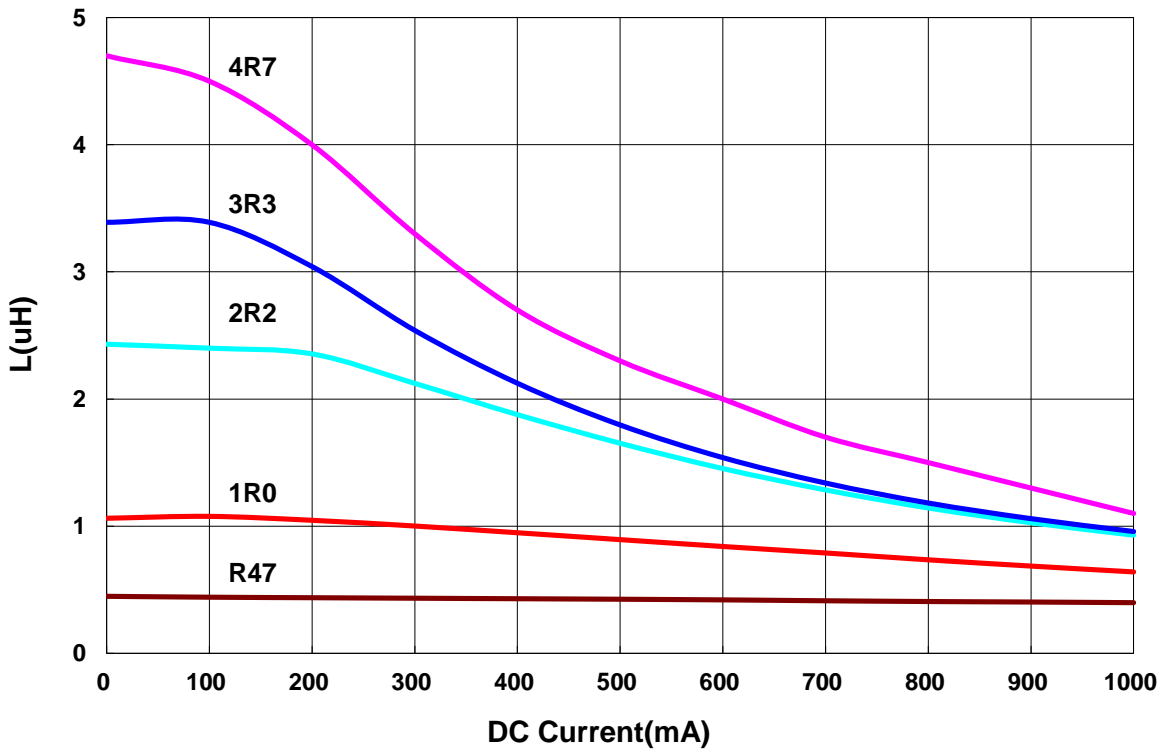

**Power Inductor AKPx Series**

**Automotive  
AEC-Q200**

**AKPE00201210 Type**

**■ Dimensions**

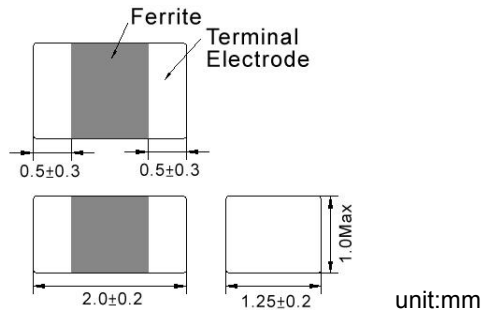

**■ Recommended Land Pattern**

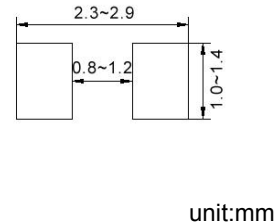

**■ Electrical Characteristics**

Part No.	Inductance	Test Freq.	RDC	Isat(mA)	Irms(mA)Max.		Tolerance
	(uH)			(Ω)±25%	Max.	85°C <sup>*1</sup>	
AKPE002012101R0□A2	1.0	3MHz,200mV	0.100	1400	1800	1300	20,30
AKPE002012102R2□A2	2.2	3MHz,200mV	0.125	500	1600	1200	20,30

**Note: When ordering, please specify tolerance code. Tolerance: M=±20% / T=±30%**

1. Operating temperature range - 40°C ~ 125°C
2. Isat for Inductance drop 30% from its value without current
3. Irms for When applied current to the Products, temperature rise caused by self-generated heat shall be limited to 40 °C max
4. As for the Rated current marked with \*1, Rated Current is depending on the operating temperature
5. Measure Equipment :  
 L : Agilent HP4287A+16197A  
 RDC : HP 4338B, or equivalent

AKPE00201210 Type

■ Characteristics Graph

Inductance vs. DC Current

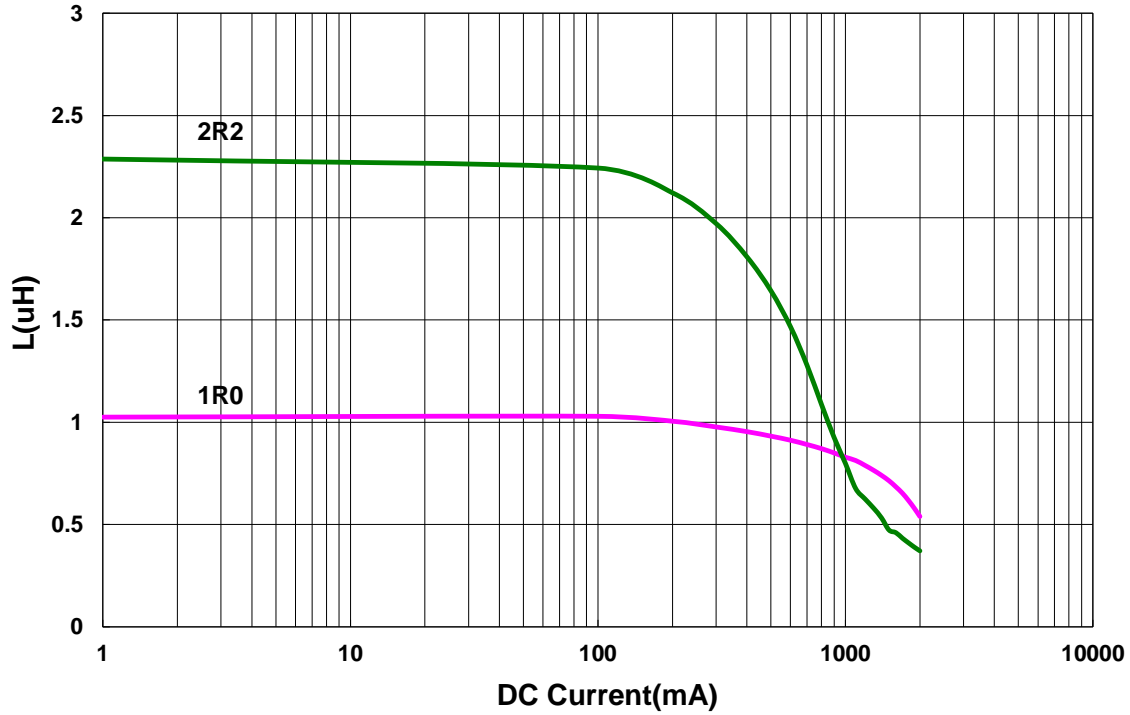

Inductance vs. DC Current

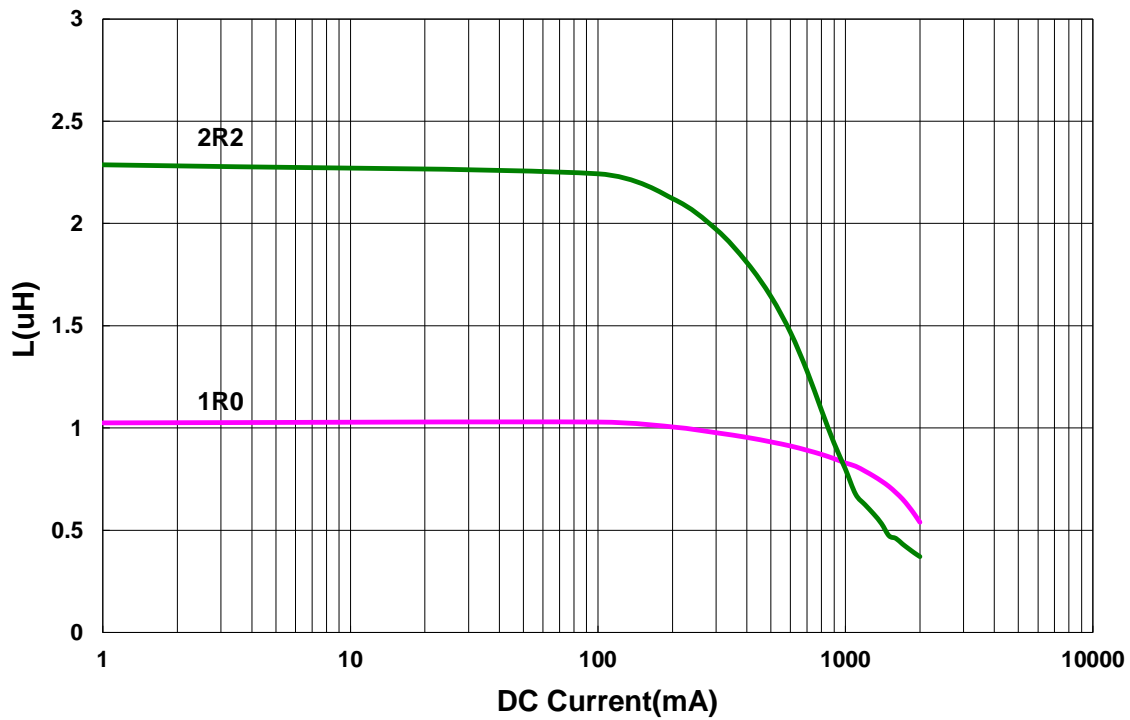

**Power Inductor AKPx Series**

**Automotive  
AEC-Q200**

**■ Packaging**

**Tape Dimensions**

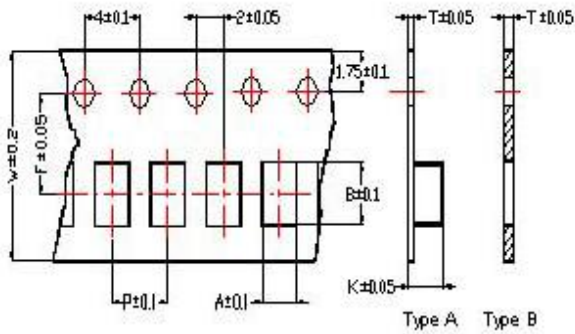

**Tape Material**

Carrier Tape: Polycarbonate (Tape A)  
Carrier Tape: Paper (Tape B)  
Cover Tape: Polystyrene

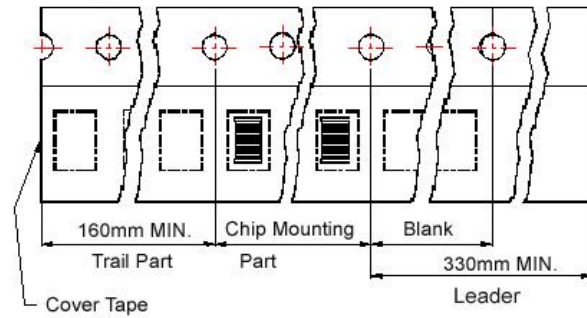

**Reel Dimensions**

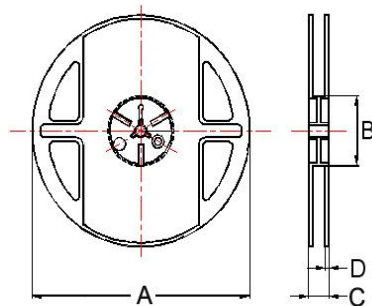

**Dimensions in mm**

TYPE	Tape Dimensions								Reel Dimensions				Quantity PCS / Reel
	A	B	T	W	P	F	K	Tape	A	B	C	D	
AKPx001608DZ	1.05	1.85	0.95	8	4	3.5	-	B	178	60	12	1.5	4000
AKPx00201210	1.45	2.25	0.22	8	4	3.5	1.04	A	178	60	12	1.5	3000
AKPx00201610	1.8	2.2	0.22	8	4	3.5	1.15	A	178	60	12	1.5	3000
AKPx00252010	2.25	2.8	0.25	8	4	3.5	1.35	A	178	60	12	1.5	3000