

SIEMENS

Ingenuity for life



国产 3SB6 系列按钮 和指示灯

目录

成套装置	3
按钮头 + 中座	6
附件	11
3SB6 按钮指示灯产品快速选型代码简介	13
技术参数	15
安装结构及外形尺寸	16

成套装置

产品类型	电压	颜色	触点类型	印字内容	产品订货号	快速选型代码*	
平头按钮							
	瞬动	● ● ● ● ○ ● ●	1NO 1NO 1NO 1NO 1NO 1NO	1NC	3SB61 □ 0-0AB20-1CA0 3SB61 □ 0-0AB40-1BA0 3SB61 □ 0-0AB50-1BA0 3SB61 □ 0-0AB30-1BA0 3SB61 □ 0-0AB60-1BA0 3SB61 □ 0-0AB10-1BA0 3SB61 □ 0-0AB10-1CA0	3SB6 □ R01 3SB6 □ G10 3SB6 □ B10 3SB6 □ Y10 3SB6 □ W10 3SB6 □ K10 3SB6 □ K01	
	瞬动	● ● ● ○ ●	1NO 1NO 1NO	1NC 1NC	带印字“O” 带印字“STOP” 带印字“I” 带印字“↑” 带印字“↑”	3SB61 6 0-0AB20-1CD0 3SB61 6 0-0AB20-1CT0 3SB61 6 0-0AB40-1BC0 3SB61 6 0-0AB60-1BS0 3SB61 6 0-0AB10-1BS0	3SB6 6 02R01 3SB6 6 08R01 3SB6 6 01G10 3SB6 6 03W10 3SB6 6 03K10
带灯平头按钮							
	瞬动	24 V AC/DC	● ● ● ● ○ 1NO	1NO 1NO 1NO 1NO 1NO	1NC	3SB61 □ 3-0DB20-1CA0 3SB61 □ 3-0DB40-1BA0 3SB61 □ 3-0DB50-1BA0 3SB61 □ 3-0DB30-1BA0 3SB61 □ 3-0DB60-1BA0	3SB6 □ D3R01 3SB6 □ D3G10 3SB6 □ D3B10 3SB6 □ D3Y10 3SB6 □ D3W10
	瞬动	110 V AC/DC	● ● ● ● ○ 1NO	1NO 1NO 1NO 1NO 1NO	1NC	3SB61 □ 5-0DB20-1CA0 3SB61 □ 5-0DB40-1BA0 3SB61 □ 5-0DB50-1BA0 3SB61 □ 5-0DB30-1BA0 3SB61 □ 5-0DB60-1BA0	3SB6 □ D5R01 3SB6 □ D5G10 3SB6 □ D5B10 3SB6 □ D5Y10 3SB6 □ D5W10
瞬动	220 V AC	● ● ● ● ○ 1NO	1NO 1NO 1NO 1NO 1NO	1NC	3SB61 □ 6-0DB20-1CA0 3SB61 □ 6-0DB40-1BA0 3SB61 □ 6-0DB50-1BA0 3SB61 □ 6-0DB30-1BA0 3SB61 □ 6-0DB60-1BA0	3SB6 □ D6R01 3SB6 □ D6G10 3SB6 □ D6B10 3SB6 □ D6Y10 3SB6 □ D6W10	

产品类型	颜色	触点类型	印字内容	产品订货号	快速选型代码*	
凸头按钮，瞬动						
	瞬动	● ● ● ● ○ ● ●	1NO 1NO 1NO 1NO 1NO 1NO	1NC	3SB61 □ 0-0BB20-1CA0 3SB61 □ 0-0BB40-1BA0 3SB61 □ 0-0BB50-1BA0 3SB61 □ 0-0BB30-1BA0 3SB61 □ 0-0BB60-1BA0 3SB61 □ 0-0BB10-1BA0 3SB61 □ 0-0BB10-1CA0	3SB6 □ HR01 3SB6 □ HG10 3SB6 □ HB10 3SB6 □ HY10 3SB6 □ HW10 3SB6 □ HK10 3SB6 □ HK01
	瞬动	● ●	1NC 1NC	带印字“O” 带印字“STOP”	3SB61 6 0-0BB20-1CD0 3SB61 6 0-0BB20-1CT0	3SB6 6 02HR01 3SB6 6 08HR01
紧凑型按钮						
	瞬动	● ● ● ● ○ ● ●	1NO 1NO 1NO 1NO 1NO 1NO	1NC 1NC 1NC 1NC 1NC 1NC	3SB6230-0AB20-1FA0 3SB6230-0AB40-1FA0 3SB6230-0AB50-1FA0 3SB6230-0AB30-1FA0 3SB6230-0AB60-1FA0 3SB6230-0AB10-1FA0	3SB62R11 3SB62G11 3SB62B11 3SB62Y11 3SB62W11 3SB62K11
	瞬动	● ● ● ● ○ ● ●	1NO 1NO 1NO 1NO 1NO 1NO	1NC 1NC	3SB6230-0AB20-1CA0 3SB6230-0AB40-1BA0 3SB6230-0AB50-1BA0 3SB6230-0AB30-1BA0 3SB6230-0AB60-1BA0 3SB6230-0AB10-1BA0 3SB6230-0AB10-1CA0	3SB62R01 3SB62G10 3SB62B10 3SB62Y10 3SB62W10 3SB62K10 3SB62K01

成套装置

	产品类型	电压	颜色	触点类型	产品订货号	快速选型代码*
蘑菇头按钮						
	拉拔解锁 40mm		●	1NC	3SB61 □ 0-1BA20-1CA0	3SB6 □ MZR01
	瞬动 40mm		● ● ● ● ○ ● ●	1NC 1NO 1NO 1NO 1NO 1NO 1NC	3SB61 □ 0-1BC20-1CA0 3SB61 □ 0-1BC40-1BA0 3SB61 □ 0-1BC50-1BA0 3SB61 □ 0-1BC30-1BA0 3SB61 □ 0-1BC60-1BA0 3SB61 □ 0-1BC10-1BA0 3SB61 □ 0-1BC10-1CA0	3SB6 □ MR01 3SB6 □ MG10 3SB6 □ MB10 3SB6 □ MY10 3SB6 □ MW10 3SB6 □ MK10 3SB6 □ MK01
急停按钮						
	旋转解锁 40mm		●	1NC	3SB61 □ 0-1HB20-1CA0	3SB6 □ JRR01
	拉拔解锁 40mm		●	1NC	3SB61 □ 0-1HA20-1CA0	3SB6 □ JLR01
	钥匙解锁 40mm		●	1NC	3SB61 □ 0-1HD20-1CA0	3SB6 □ JKR01
急停按钮，带触发功能						
	旋转解锁 带触发功能 40mm		●	1NC	3SB61 □ 0-1EB20-1CA0	3SB6 □ JARR01
	拉拔解锁 带触发功能 40mm		●	1NC	3SB61 □ 0-1EA20-1CA0	3SB6 □ JALR01
	钥匙解锁 带触发功能 40mm		●	1NC	3SB61 □ 0-1ED20-1CA0	3SB6 □ JAKR01
双位按钮						
	瞬动		●●	1NO 1NC	3SB61 □ 0-3AA24-1MK0	3SB6 □ TRG11
	瞬动 带灯	24 V AC/DC	●●	1NO 1NC	3SB61 □ 3-3CA24-1MK0	3SB6 □ TD3RG11
	瞬动 带灯	110 V AC/DC	●●	1NO 1NC	3SB61 □ 5-3CA24-1MK0	3SB6 □ TD5RG11
	瞬动 带灯	220 V AC	●●	1NO 1NC	3SB61 □ 6-3CA24-1MK0	3SB6 □ TD6RG11

*此快速选型代码仅供选型使用；向西门子下单时，需使用产品订货号

订货须知: 产品订货号以及快速选型代码中的 □ 需用数字取代，即：金属亮光，6

金属化，3

产品类型		颜色	触点类型	产品订货号	快速选型代码*	
选择按钮						
	旋钮 (短柄)	 2 位, 90°	●	1NO	3SB61 □ 0-2AA10-1BA0	3SB6 □ XZK10
		 3 位, 2 × 60°	●	2 × 1NO	3SB61 □ 0-2AL10-1NA0	3SB6 □ X3ZK20
		 3 位, 2 × 60°	●	2 × 1NO	3SB61 □ 0-2AM10-1NA0	3SB6 □ X3K20
		 3 位, 2 × 60°	●	2 × 1NO	3SB61 □ 0-2AN10-1NA0	3SB6 □ X3RK20
		 3 位, 2 × 60°	●	2 × 1NO	3SB61 □ 0-2AP10-1NA0	3SB6 □ X3LK20
	旋钮 (长柄)	 2 位, 90°	●	1NO	3SB61 □ 0-2BA10-1BA0	3SB6 □ SZK10
		 3 位, 2 × 60°	●	2 × 1NO	3SB61 □ 0-2BL10-1NA0	3SB6 □ S3ZK20
		 3 位, 2 × 60°	●	2 × 1NO	3SB61 □ 0-2BM10-1NA0	3SB6 □ S3K20
		 3 位, 2 × 60°	●	2 × 1NO	3SB61 □ 0-2BN10-1NA0	3SB6 □ S3RK20
		 3 位, 2 × 60°	●	2 × 1NO	3SB61 □ 0-2BP10-1NA0	3SB6 □ S3LK20
钥匙操作按钮						
		 2 位, 90°	●	1NO	3SB61 □ 0-4AA01-1BA0	3SB6 □ KZL10
		 2 位, 90°	●	1NO	3SB61 □ 0-4AA11-1BA0	3SB6 □ KZE10
		 2 位, 90°	●	1NO	3SB61 □ 0-4AA21-1BA0	3SB6 □ KZR10
		 3 位, 2 × 60°	●	2 × 1NO	3SB61 □ 0-4AL01-1NA0	3SB6 □ K3ZC20
		 3 位, 2 × 60°	●	2 × 1NO	3SB61 □ 0-4AL11-1NA0	3SB6 □ K3ZE20
		 3 位, 2 × 60°	●	2 × 1NO	3SB61 □ 0-4AM01-1NA0	3SB6 □ K3C20

注:  自锁  瞬动  钥匙拔出位

电压	颜色	产品订货号	快速选型代码*	电压	颜色	产品订货号	快速选型代码*		
指示灯									
	6 V	●	3SB6211-6AA20-1AA0	3SB62D1R		110 V	●	3SB6215-6AA20-1AA0	3SB62D5R
	AC/DC	●	3SB6211-6AA30-1AA0	3SB62D1Y		●	3SB6215-6AA30-1AA0	3SB62D5Y	
		●	3SB6211-6AA40-1AA0	3SB62D1G		●	3SB6215-6AA40-1AA0	3SB62D5G	
		●	3SB6211-6AA50-1AA0	3SB62D1B		●	3SB6215-6AA50-1AA0	3SB62D5B	
		○	3SB6211-6AA60-1AA0	3SB62D1W		○	3SB6215-6AA60-1AA0	3SB62D5W	
12 V	●	3SB6212-6AA20-1AA0	3SB62D2R	125 V	●	3SB6210-6AB20-1AA0	3SB62D9R		
	●	3SB6212-6AA30-1AA0	3SB62D2Y		●	3SB6210-6AB30-1AA0	3SB62D9Y		
	●	3SB6212-6AA40-1AA0	3SB62D2G		●	3SB6210-6AB40-1AA0	3SB62D9G		
	●	3SB6212-6AA50-1AA0	3SB62D2B		●	3SB6210-6AB50-1AA0	3SB62D9B		
	○	3SB6212-6AA60-1AA0	3SB62D2W		○	3SB6210-6AB60-1AA0	3SB62D9W		
24 V	●	3SB6213-6AA20-1AA0	3SB62D3R	220 V	●	3SB6216-6AA20-1AA0	3SB62D6R		
	●	3SB6213-6AA30-1AA0	3SB62D3Y		●	3SB6216-6AA30-1AA0	3SB62D6Y		
	●	3SB6213-6AA40-1AA0	3SB62D3G		●	3SB6216-6AA40-1AA0	3SB62D6G		
	●	3SB6213-6AA50-1AA0	3SB62D3B		●	3SB6216-6AA50-1AA0	3SB62D6B		
	○	3SB6213-6AA60-1AA0	3SB62D3W		○	3SB6216-6AA60-1AA0	3SB62D6W		
48 V	●	3SB6214-6AA20-1AA0	3SB62D4R	220 V	●	3SB6217-6AA20-1AA0	3SB62D7R		
	●	3SB6214-6AA30-1AA0	3SB62D4Y		●	3SB6217-6AA30-1AA0	3SB62D7Y		
	●	3SB6214-6AA40-1AA0	3SB62D4G		●	3SB6217-6AA40-1AA0	3SB62D7G		
	●	3SB6214-6AA50-1AA0	3SB62D4B		●	3SB6217-6AA50-1AA0	3SB62D7B		
	○	3SB6214-6AA60-1AA0	3SB62D4W		○	3SB6217-6AA60-1AA0	3SB62D7W		
380 V	●	3SB6218-6AA20-1AA0	3SB62D8R	AC	●	3SB6218-6AA20-1AA0	3SB62D8R		
	●	3SB6218-6AA30-1AA0	3SB62D8Y		●	3SB6218-6AA30-1AA0	3SB62D8Y		
	●	3SB6218-6AA40-1AA0	3SB62D8G		●	3SB6218-6AA40-1AA0	3SB62D8G		
	●	3SB6218-6AA50-1AA0	3SB62D8B		●	3SB6218-6AA50-1AA0	3SB62D8B		
	○	3SB6218-6AA60-1AA0	3SB62D8W		○	3SB6218-6AA60-1AA0	3SB62D8W		

产品类型	电压	颜色	产品订货号	快速选型代码*
蜂鸣器 	持续发声	24V AC/DC	● 3SB6210-7AB10-1AA0	3SB62FH3
	持续发声	110V AC/DC	● 3SB6210-7AC10-1AA0	3SB62FH5
	持续发声	220V AC/DC	● 3SB6210-7AF10-1AA0	3SB62FH6
	持续发声, 持续发光	24V AC/DC	● 3SB6213-7AA20-1AA0	3SB62FN3
	持续发声, 持续发光	110V AC/DC	● 3SB6215-7AA20-1AA0	3SB62FN5
	持续发声, 持续发光	220V AC/DC	● 3SB6216-7AA20-1AA0	3SB62FN6

按钮头 + 中座

产品类型 及颜色	印字内容	产品订货号	快速选型代码*	产品类型 及颜色	产品订货号	快速选型代码*
平头按钮						
	瞬动			自锁		
	● 带印字 "O"	3SB60 □ 0-0AB20-0YA0	3SB6 □ R	● 3SB60 □ 0-0AA20-0YA0	3SB6 □ ZR	
	● 带印字 "STOP"	3SB60 □ 0-0AB40-0YA0	3SB6 □ G	● 3SB60 □ 0-0AA40-0YA0	3SB6 □ ZG	
	● 带印字 "I"	3SB60 □ 0-0AB50-0YA0	3SB6 □ B	● 3SB60 □ 0-0AA50-0YA0	3SB6 □ ZB	
	● 带印字 "II"	3SB60 □ 0-0AB30-0YA0	3SB6 □ Y	● 3SB60 □ 0-0AA30-0YA0	3SB6 □ ZY	
	○ 带印字 "II"	3SB60 □ 0-0AB60-0YA0	3SB6 □ W	○ 3SB60 □ 0-0AA60-0YA0	3SB6 □ ZW	
	○ 带印字 "↑"	3SB60 □ 0-0AB10-0YA0	3SB6 □ K	● 3SB60 □ 0-0AA10-0YA0	3SB6 □ ZK	
	○ 带印字 "↑"	3SB60 6 0-0AB20-0YD0	3SB6 6 02R			
	● 带印字 "O"	3SB60 6 0-0AB20-0YT0	3SB6 6 08R			
	● 带印字 "I"	3SB60 6 0-0AB40-0YCO	3SB6 6 01G			
	● 带印字 "II"	3SB60 6 0-0AB40-0YW0	3SB6 6 06G			
	○ 带印字 "II"	3SB60 6 0-0AB60-0YW0	3SB6 6 06W			
	○ 带印字 "↑"	3SB60 6 0-0AB60-0YS0	3SB6 6 03W			
	● 带印字 "↑"	3SB60 6 0-0AB10-0YS0	3SB6 6 03K			
	● 带印字 "O"	3SB60 6 0-0AB10-0YD0	3SB6 6 02K			
凸头按钮						
	瞬动			自锁		
	● 带印字 "O"	3SB60 □ 0-0BB20-0YA0	3SB6 □ HR	● 3SB60 □ 0-0BA20-0YA0	3SB6 □ HZR	
	● 带印字 "STOP"	3SB60 □ 0-0BB40-0YA0	3SB6 □ HG	● 3SB60 □ 0-0BA40-0YA0	3SB6 □ HZG	
	● 带印字 "I"	3SB60 □ 0-0BB50-0YA0	3SB6 □ HB	● 3SB60 □ 0-0BA50-0YA0	3SB6 □ HZB	
	● 带印字 "II"	3SB60 □ 0-0BB30-0YA0	3SB6 □ HY	● 3SB60 □ 0-0BA30-0YA0	3SB6 □ HZY	
	○ 带印字 "II"	3SB60 □ 0-0BB60-0YA0	3SB6 □ HW	○ 3SB60 □ 0-0BA60-0YA0	3SB6 □ HZW	
	○ 带印字 "↑"	3SB60 □ 0-0BB10-0YA0	3SB6 □ HK	● 3SB60 □ 0-0BA10-0YA0	3SB6 □ HZK	
	○ 带印字 "↑"	3SB60 6 0-0BB20-0YD0	3SB6 6 02HR			
	● 带印字 "O"	3SB60 6 0-0BB20-0YT0	3SB6 6 08HR			
	● 带印字 "I"	3SB60 6 0-0BB40-0YCO	3SB6 6 08HK			
	● 带印字 "II"	3SB60 6 0-0BB40-0YW0				
	○ 带印字 "II"	3SB60 6 0-0BB60-0YW0				
	○ 带印字 "↑"	3SB60 6 0-0BB60-0YS0				
	● 带印字 "↑"	3SB60 6 0-0BB10-0YS0				
	● 带印字 "O"	3SB60 6 0-0BB10-0YD0				
带灯平头按钮						
	瞬动			自锁		
	● 带印字 "O"	3SB60 □ 1-0AB20-0YA0	3SB6 □ DR	● 3SB60 □ 1-0AA20-0YA0	3SB6 □ ZDR	
	● 带印字 "STOP"	3SB60 □ 1-0AB40-0YA0	3SB6 □ DG	● 3SB60 □ 1-0AA40-0YA0	3SB6 □ ZDG	
	● 带印字 "I"	3SB60 □ 1-0AB50-0YA0	3SB6 □ DB	● 3SB60 □ 1-0AA50-0YA0	3SB6 □ ZDB	
	● 带印字 "II"	3SB60 □ 1-0AB30-0YA0	3SB6 □ DY	● 3SB60 □ 1-0AA30-0YA0	3SB6 □ ZDY	
	○ 带印字 "II"	3SB60 □ 1-0AB60-0YA0	3SB6 □ DW	○ 3SB60 □ 1-0AA60-0YA0	3SB6 □ ZDW	
	○ 带印字 "↑"					
	○ 带印字 "↑"					
	○ 带印字 "O"					
带灯凸头按钮						
	瞬动			自锁		
	● 带印字 "O"	3SB60 □ 1-0BB20-0YA0	3SB6 □ HDR	● 3SB60 □ 1-0BA20-0YA0	3SB6 □ HZDR	
	● 带印字 "STOP"	3SB60 □ 1-0BB40-0YA0	3SB6 □ HDG	● 3SB60 □ 1-0BA40-0YA0	3SB6 □ HZDG	
	● 带印字 "I"	3SB60 □ 1-0BB50-0YA0	3SB6 □ HDB	● 3SB60 □ 1-0BA50-0YA0	3SB6 □ HZDB	
	● 带印字 "II"	3SB60 □ 1-0BB30-0YA0	3SB6 □ HDY	● 3SB60 □ 1-0BA30-0YA0	3SB6 □ HZDY	
	○ 带印字 "II"	3SB60 □ 1-0BB60-0YA0	3SB6 □ HDW	○ 3SB60 □ 1-0BA60-0YA0	3SB6 □ HZDW	
	○ 带印字 "↑"					
	○ 带印字 "↑"					
	○ 带印字 "O"					

*此快速选型代码仅供选型使用，向西门子下单时，需使用产品订货号

订货须知: 产品订货号以及快速选型代码中的 □ 需用数字取代，即：金属亮光，6

金属化，3

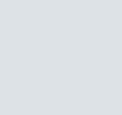
产品类型	颜色	产品订货号	快速选型代码*	产品类型	颜色	产品订货号	快速选型代码*
旋钮（短柄）							
	2 位, 90° 	● 3SB60 □ 0-2AA10-0YA0	3SB6 □ XZK	3 位, 2×60° 	● 3SB60 □ 0-2AM10-0YA0	3SB6 □ X3K	
		● 3SB60 □ 0-2AA20-0YA0	3SB6 □ XZR		● 3SB60 □ 0-2AM20-0YA0	3SB6 □ X3R	
		● 3SB60 □ 0-2AA30-0YA0	3SB6 □ XZY		● 3SB60 □ 0-2AM30-0YA0	3SB6 □ X3Y	
		● 3SB60 □ 0-2AA40-0YA0	3SB6 □ XZG		● 3SB60 □ 0-2AM40-0YA0	3SB6 □ X3G	
		● 3SB60 □ 0-2AA50-0YA0	3SB6 □ XZB		● 3SB60 □ 0-2AM50-0YA0	3SB6 □ X3B	
○ 3SB60 □ 0-2AA60-0YA0	3SB6 □ XZW	○ 3SB60 □ 0-2AM60-0YA0	3SB6 □ X3W				
	2 位, 90° 	● 3SB60 □ 0-2AB10-0YA0	3SB6 □ XK	3 位, 2×60° 	● 3SB60 □ 0-2AN10-0YA0	3SB6 □ X3RK	
		● 3SB60 □ 0-2AB20-0YA0	3SB6 □ XR		● 3SB60 □ 0-2AN20-0YA0	3SB6 □ X3RR	
		● 3SB60 □ 0-2AB30-0YA0	3SB6 □ XY		● 3SB60 □ 0-2AN30-0YA0	3SB6 □ X3RY	
		● 3SB60 □ 0-2AB40-0YA0	3SB6 □ XG		● 3SB60 □ 0-2AN40-0YA0	3SB6 □ X3RG	
		● 3SB60 □ 0-2AB50-0YA0	3SB6 □ XB		● 3SB60 □ 0-2AN50-0YA0	3SB6 □ X3RB	
○ 3SB60 □ 0-2AB60-0YA0	3SB6 □ XW	○ 3SB60 □ 0-2AN60-0YA0	3SB6 □ X3RW				
	3 位, 2×60° 	● 3SB60 □ 0-2AL10-0YA0	3SB6 □ X3ZK	3 位, 2×60° 	● 3SB60 □ 0-2AP10-0YA0	3SB6 □ X3LK	
		● 3SB60 □ 0-2AL20-0YA0	3SB6 □ X3ZR		● 3SB60 □ 0-2AP20-0YA0	3SB6 □ X3LR	
		● 3SB60 □ 0-2AL30-0YA0	3SB6 □ X3ZY		● 3SB60 □ 0-2AP30-0YA0	3SB6 □ X3LY	
		● 3SB60 □ 0-2AL40-0YA0	3SB6 □ X3ZG		● 3SB60 □ 0-2AP40-0YA0	3SB6 □ X3LG	
		● 3SB60 □ 0-2AL50-0YA0	3SB6 □ X3ZB		● 3SB60 □ 0-2AP50-0YA0	3SB6 □ X3LB	
○ 3SB60 □ 0-2AL60-0YA0	3SB6 □ X3ZW	○ 3SB60 □ 0-2AP60-0YA0	3SB6 □ X3LW				

注：  自锁  瞬动

产品类型	颜色	产品订货号	快速选型代码*
旋钮（长柄）			
	2 位, 90°	● 3SB60 □ 0-2BA10-0YA0 ▽ ● 3SB60 □ 0-2BA20-0YA0 ● 3SB60 □ 0-2BA30-0YA0 ● 3SB60 □ 0-2BA40-0YA0 ● 3SB60 □ 0-2BA50-0YA0 ○ 3SB60 □ 0-2BA60-0YA0	3SB6 □ SZK 3SB6 □ SZR 3SB6 □ SZY 3SB6 □ SZG 3SB6 □ SZB 3SB6 □ SZW
	2 位, 90°	● 3SB60 □ 0-2BB10-0YA0 ▽ ● 3SB60 □ 0-2BB20-0YA0 ● 3SB60 □ 0-2BB30-0YA0 ● 3SB60 □ 0-2BB40-0YA0 ● 3SB60 □ 0-2BB50-0YA0 ○ 3SB60 □ 0-2BB60-0YA0	3SB6 □ SK 3SB6 □ SR 3SB6 □ SY 3SB6 □ SG 3SB6 □ SB 3SB6 □ SW
	3 位, 2 × 60°	● 3SB60 □ 0-2BL10-0YA0 ▽ ● 3SB60 □ 0-2BL20-0YA0 ● 3SB60 □ 0-2BL30-0YA0 ● 3SB60 □ 0-2BL40-0YA0 ● 3SB60 □ 0-2BL50-0YA0 ○ 3SB60 □ 0-2BL60-0YA0	3SB6 □ S3ZK 3SB6 □ S3ZR 3SB6 □ S3ZY 3SB6 □ S3ZG 3SB6 □ S3ZB 3SB6 □ S3ZW
	3 位, 2 × 60°	● 3SB60 □ 0-2BM10-0YA0 ▽ ● 3SB60 □ 0-2BM20-0YA0 ● 3SB60 □ 0-2BM30-0YA0 ● 3SB60 □ 0-2BM40-0YA0 ● 3SB60 □ 0-2BM50-0YA0 ○ 3SB60 □ 0-2BM60-0YA0	3SB6 □ S3K 3SB6 □ S3R 3SB6 □ S3Y 3SB6 □ S3G 3SB6 □ S3B 3SB6 □ S3W
	3 位, 2 × 60°	● 3SB60 □ 0-2BN10-0YA0 ▽ ● 3SB60 □ 0-2BN20-0YA0 ● 3SB60 □ 0-2BN30-0YA0 ● 3SB60 □ 0-2BN40-0YA0 ● 3SB60 □ 0-2BN50-0YA0 ○ 3SB60 □ 0-2BN60-0YA0	3SB6 □ S3RK 3SB6 □ S3RR 3SB6 □ S3RY 3SB6 □ S3RG 3SB6 □ S3RB 3SB6 □ S3RW
	3 位, 2 × 60°	● 3SB60 □ 0-2BP10-0YA0 ▽ ● 3SB60 □ 0-2BP20-0YA0 ● 3SB60 □ 0-2BP30-0YA0 ● 3SB60 □ 0-2BP40-0YA0 ● 3SB60 □ 0-2BP50-0YA0 ○ 3SB60 □ 0-2BP60-0YA0	3SB6 □ S3LK 3SB6 □ S3LR 3SB6 □ S3LY 3SB6 □ S3LG 3SB6 □ S3LB 3SB6 □ S3LW

产品类型	产品订货号	快速选型代码*	
钥匙操作按钮			
	2 位, 90°	3SB60 □ 0-4AA21-0YA0	3SB6 □ KZR
	2 位, 90°	3SB60 □ 0-4AA01-0YA0	3SB6 □ KZL
	2 位, 90°	3SB60 □ 0-4AA11-0YA0	3SB6 □ KZE
	2 位, 90°	3SB60 □ 0-4AB01-0YA0	3SB6 □ KL
	2 位, 9-12 点钟方向	3SB60 □ 0-4AG01-0YA0	3SB6 □ KAL
	3 位, 2 × 60°	3SB60 □ 0-4AL01-0YA0	3SB6 □ K3ZC
	3 位, 2 × 60°	3SB60 □ 0-4AL11-0YA0	3SB6 □ K3ZE
	3 位, 2 × 60°	3SB60 □ 0-4AM01-0YA0	3SB6 □ K3C
	3 位, 2 × 60°	3SB60 □ 0-4AP01-0YA0	3SB6 □ K3LC
	3 位, 2 × 60°	3SB60 □ 0-4AN01-0YA0	3SB6 □ K3RC
	3 位, 2 × 60°	3SB60 □ 0-4AP61-0YA0	3SB6 □ K3LRC
3 位, 2 × 60°	3SB60 □ 0-4AN51-0YA0	3SB6 □ K3RLC	

注：▽ 自锁 ▽ 瞬动 ⚙ 钥匙拔出位

注：▽ 自锁 ▽ 瞬动

*此快速选型代码仅供选型使用；向西门子下单时，需使用产品订货号

订货须知：产品订货号以及快速选型代码中的 □ 需用数字取代，即：金属亮光，6

金属化，3

产品类型 颜色 产品订货号 快速选型代码*				产品类型 颜色 产品订货号 快速选型代码*			
带灯旋钮 (短柄)				带灯旋钮 (长柄)			
	2 位, 90° ✓	● 3SB60 □ 1-2AA20-0YA0	3SB6 □ XZDR		2 位, 90° ✓	● 3SB60 □ 1-2BA20-0YA0	3SB6 □ SZDR
		● 3SB60 □ 1-2AA30-0YA0	3SB6 □ XZDY			● 3SB60 □ 1-2BA30-0YA0	3SB6 □ SZDY
		● 3SB60 □ 1-2AA40-0YA0	3SB6 □ XZDG			● 3SB60 □ 1-2BA40-0YA0	3SB6 □ SZDG
		● 3SB60 □ 1-2AA50-0YA0	3SB6 □ XZDB			● 3SB60 □ 1-2BA50-0YA0	3SB6 □ SZDB
		○ 3SB60 □ 1-2AA60-0YA0	3SB6 □ XZDW			○ 3SB60 □ 1-2BA60-0YA0	3SB6 □ SZDW
	2 位, 90° ∩	● 3SB60 □ 1-2AB20-0YA0	3SB6 □ XDR		2 位, 90° ∩	● 3SB60 □ 1-2BB20-0YA0	3SB6 □ SDR
		● 3SB60 □ 1-2AB30-0YA0	3SB6 □ XDY			● 3SB60 □ 1-2BB30-0YA0	3SB6 □ SDY
		● 3SB60 □ 1-2AB40-0YA0	3SB6 □ XDG			● 3SB60 □ 1-2BB40-0YA0	3SB6 □ SDG
		● 3SB60 □ 1-2AB50-0YA0	3SB6 □ XDB			● 3SB60 □ 1-2BB50-0YA0	3SB6 □ SDB
		○ 3SB60 □ 1-2AB60-0YA0	3SB6 □ XDW			○ 3SB60 □ 1-2BB60-0YA0	3SB6 □ SDW
	3 位, 2 × 60° ↓	● 3SB60 □ 1-2AL20-0YA0	3SB6 □ X3ZDR		3 位, 2 × 60° ↓	● 3SB60 □ 1-2BL20-0YA0	3SB6 □ S3ZDR
		● 3SB60 □ 1-2AL30-0YA0	3SB6 □ X3ZDY			● 3SB60 □ 1-2BL30-0YA0	3SB6 □ S3ZDY
		● 3SB60 □ 1-2AL40-0YA0	3SB6 □ X3ZDG			● 3SB60 □ 1-2BL40-0YA0	3SB6 □ S3ZDG
		● 3SB60 □ 1-2AL50-0YA0	3SB6 □ X3ZDB			● 3SB60 □ 1-2BL50-0YA0	3SB6 □ S3ZDB
		○ 3SB60 □ 1-2AL60-0YA0	3SB6 □ X3ZDW			○ 3SB60 □ 1-2BL60-0YA0	3SB6 □ S3ZDW
	3 位, 2 × 60° ↔	● 3SB60 □ 1-2AM20-0YA0	3SB6 □ X3DR		3 位, 2 × 60° ↔	● 3SB60 □ 1-2BM20-0YA0	3SB6 □ S3DR
		● 3SB60 □ 1-2AM30-0YA0	3SB6 □ X3DY			● 3SB60 □ 1-2BM30-0YA0	3SB6 □ S3DY
		● 3SB60 □ 1-2AM40-0YA0	3SB6 □ X3DG			● 3SB60 □ 1-2BM40-0YA0	3SB6 □ S3DG
		● 3SB60 □ 1-2AM50-0YA0	3SB6 □ X3DB			● 3SB60 □ 1-2BM50-0YA0	3SB6 □ S3DB
		○ 3SB60 □ 1-2AM60-0YA0	3SB6 □ X3DW			○ 3SB60 □ 1-2BM60-0YA0	3SB6 □ S3DW
	3 位, 2 × 60° ↘	● 3SB60 □ 1-2AN20-0YA0	3SB6 □ X3RDR		3 位, 2 × 60° ↘	● 3SB60 □ 1-2BN20-0YA0	3SB6 □ S3RDR
		● 3SB60 □ 1-2AN30-0YA0	3SB6 □ X3RDY			● 3SB60 □ 1-2BN30-0YA0	3SB6 □ S3RDY
		● 3SB60 □ 1-2AN40-0YA0	3SB6 □ X3RDG			● 3SB60 □ 1-2BN40-0YA0	3SB6 □ S3RDG
		● 3SB60 □ 1-2AN50-0YA0	3SB6 □ X3RDB			● 3SB60 □ 1-2BN50-0YA0	3SB6 □ S3RDB
		○ 3SB60 □ 1-2AN60-0YA0	3SB6 □ X3RDW			○ 3SB60 □ 1-2BN60-0YA0	3SB6 □ S3RDW
	3 位, 2 × 60° ↙	● 3SB60 □ 1-2AP20-0YA0	3SB6 □ X3LDR		3 位, 2 × 60° ↙	● 3SB60 □ 1-2BP20-0YA0	3SB6 □ S3LDR
		● 3SB60 □ 1-2AP30-0YA0	3SB6 □ X3LDY			● 3SB60 □ 1-2BP30-0YA0	3SB6 □ S3LDY
		● 3SB60 □ 1-2AP40-0YA0	3SB6 □ X3LDG			● 3SB60 □ 1-2BP40-0YA0	3SB6 □ S3LDG
		● 3SB60 □ 1-2AP50-0YA0	3SB6 □ X3LDB			● 3SB60 □ 1-2BP50-0YA0	3SB6 □ S3LDB
		○ 3SB60 □ 1-2AP60-0YA0	3SB6 □ X3LDW			○ 3SB60 □ 1-2BP60-0YA0	3SB6 □ S3LDW

产品类型 颜色		30mm	40mm	60mm
蘑菇头按钮				
	拉拔解锁	●		3SB60 □ 0-1BA20-0YA0
		●		3SB60 □ 0-1BA30-0YA0
		●		3SB60 □ 0-1BA40-0YA0
		●		3SB60 □ 0-1BA10-0YA0
		●		3SB60 □ 0-1BA50-0YA0
		○		3SB60 □ 0-1BA60-0YA0
	瞬动	●	3SB60 □ 0-1AC20-0YA0	3SB60 □ 0-1BC20-0YA0
		●	3SB60 □ 0-1AC30-0YA0	3SB60 □ 0-1BC30-0YA0
		●	3SB60 □ 0-1AC40-0YA0	3SB60 □ 0-1BC40-0YA0
		●	3SB60 □ 0-1AC10-0YA0	3SB60 □ 0-1BC10-0YA0
		●	3SB60 □ 0-1AC50-0YA0	3SB60 □ 0-1BC50-0YA0
		○	3SB60 □ 0-1AC60-0YA0	3SB60 □ 0-1BC60-0YA0
带灯蘑菇头按钮				
	瞬动	●	3SB60 □ 1-1AC20-0YA0	3SB60 □ 1-1BC20-0YA0
		●	3SB60 □ 1-1AC30-0YA0	3SB60 □ 1-1BC30-0YA0
		●	3SB60 □ 1-1AC40-0YA0	3SB60 □ 1-1BC40-0YA0
		●	3SB60 □ 1-1AC50-0YA0	3SB60 □ 1-1BC50-0YA0
		○	3SB60 □ 1-1AC60-0YA0	3SB60 □ 1-1BC60-0YA0
				

产品类型		颜色	30mm		40mm			
急停按钮								
	旋转解锁	●	3SB60 □ 0-1GB20-0YA0	3SB6 □ J3RR	3SB60 □ 0-1HB20-0YA0	3SB6 □ JRR		
	拉拔解锁	●			3SB60 □ 0-1HA20-0YA0	3SB6 □ JLR		
	钥匙解锁	●	3SB60 □ 0-1GD20-0YA0	3SB6 □ J3KR	3SB60 □ 0-1HD20-0YA0	3SB6 □ JKR		
急停按钮，带触发功能								
	旋转解锁，带触发功能	●			3SB60 □ 0-1EB20-0YA0	3SB6 □ JARR		
	拉拔解锁，带触发功能	●			3SB60 □ 0-1EA20-0YA0	3SB6 □ JALR		
	钥匙解锁，带触发功能	●			3SB60 □ 0-1ED20-0YA0	3SB6 □ JAKR		
产品类型	颜色	产品订货号	快速选型代码*		产品类型	颜色	产品订货号	快速选型代码*
双位按钮				按钮盒				
	瞬动	● ●	3SB60 □ 0-3AA24-0YK0	3SB6 □ TRG		1 孔急停按钮盒，上盖为黄色	● 3SB6811-0AA10-0BA0	3SB69K1Y
	瞬动，带灯	● ●	3SB60 □ 1-3AA24-0YK0	3SB6 □ TDRG				
						2 孔按钮盒	● 3SB6812-0AA10-0BA0	3SB69K2GY
						3 孔按钮盒	● 3SB6813-0AA10-0BA0	3SB69K3GY
						4 孔按钮盒	● 3SB6814-0AA10-0BA0	3SB69K4GY
						5 孔按钮盒	● 3SB6815-0AA10-0BA0	3SB69K5GY
按钮盒								
	1 孔按钮盒	●	3SB6811-0AA10-0BA0	3SB69K1GY				

*此快速选型代码仅供选型使用；向西门子下单时，需使用产品订货号

订货须知: 产品订货号以及快速选型代码中的 □ 需用数字取代，即：金属亮光，**6**

金属化，**3**

附件

产品类型	产品订货号	快速选型代码*	
触点模块	1NO	3SB6400-1AA10-1BA0	3SB69C10
	1NC	3SB6400-1AA10-1CA0	3SB69C01

电压	颜色	产品订货号	快速选型代码*	电压	颜色	产品订货号	快速选型代码*
LED 模块	6V AC/DC	● 3SB6401-1BA20-1AA0	3SB69D1R	110V AC/DC	● 3SB6405-1BA20-1AA0	3SB69D5R	
		● 3SB6401-1BA30-1AA0	3SB69D1Y		● 3SB6405-1BA30-1AA0	3SB69D5Y	
		● 3SB6401-1BA40-1AA0	3SB69D1G		● 3SB6405-1BA40-1AA0	3SB69D5G	
		● 3SB6401-1BA50-1AA0	3SB69D1B		● 3SB6405-1BA50-1AA0	3SB69D5B	
		○ 3SB6401-1BA60-1AA0	3SB69D1W		○ 3SB6405-1BA60-1AA0	3SB69D5W	
	12V AC/DC	● 3SB6402-1BA20-1AA0	3SB69D2R	220V AC	● 3SB6406-1BA20-1AA0	3SB69D6R	
		● 3SB6402-1BA30-1AA0	3SB69D2Y		● 3SB6406-1BA30-1AA0	3SB69D6Y	
		● 3SB6402-1BA40-1AA0	3SB69D2G		● 3SB6406-1BA40-1AA0	3SB69D6G	
		● 3SB6402-1BA50-1AA0	3SB69D2B		● 3SB6406-1BA50-1AA0	3SB69D6B	
		○ 3SB6402-1BA60-1AA0	3SB69D2W		○ 3SB6406-1BA60-1AA0	3SB69D6W	
	24V AC/DC	● 3SB6403-1BA20-1AA0	3SB69D3R	220V DC	● 3SB6407-1BA20-1AA0	3SB69D7R	
		● 3SB6403-1BA30-1AA0	3SB69D3Y		● 3SB6407-1BA30-1AA0	3SB69D7Y	
		● 3SB6403-1BA40-1AA0	3SB69D3G		● 3SB6407-1BA40-1AA0	3SB69D7G	
		● 3SB6403-1BA50-1AA0	3SB69D3B		● 3SB6407-1BA50-1AA0	3SB69D7B	
		○ 3SB6403-1BA60-1AA0	3SB69D3W		○ 3SB6407-1BA60-1AA0	3SB69D7W	
	48V AC/DC	● 3SB6404-1BA20-1AA0	3SB69D4R	380V AC	● 3SB6408-1BA20-1AA0	3SB69D8R	
		● 3SB6404-1BA30-1AA0	3SB69D4Y		● 3SB6408-1BA30-1AA0	3SB69D8Y	
		● 3SB6404-1BA40-1AA0	3SB69D4G		● 3SB6408-1BA40-1AA0	3SB69D8G	
		● 3SB6404-1BA50-1AA0	3SB69D4B		● 3SB6408-1BA50-1AA0	3SB69D8B	
		○ 3SB6404-1BA60-1AA0	3SB69D4W		○ 3SB6408-1BA60-1AA0	3SB69D8W	

附件

产品类型	颜色	产品订货号	快速选型代码*	产品类型	产品订货号	快速选型代码*
 红色灯罩 绿色灯罩 蓝色灯罩 黄色灯罩 白色灯罩	●	3SB6901-0GH20	3SB69LR	指示灯符号片 (用于指示灯印字)		
	●	3SB6901-0GH40	3SB69LG	塑料, 指示灯符号片	3SB6900-0PG	3SB69E
	●	3SB6901-0GH50	3SB69LB	指示灯符号片-START	3SB6900-0NA	3SB69E07
	●	3SB6901-0GH30	3SB69LY	指示灯符号片-STOP	3SB6900-0NB	3SB69E08
	○	3SB6901-0GH60	3SB69LW	指示灯符号片-ON	3SB6900-0NC	3SB69E09
 防护盖, 用于 平头/凸头按钮		3SB6900-0BC	3SB69P	指示灯符号片-OFF	3SB6900-0ND	3SB69E10
 防护盖, 用于 双位按钮		3SB6900-0BJ	3SB69PT	指示灯符号片-UP	3SB6900-0NE	3SB69E11
 密封塞		3SB6900-0AV60	3SB69B	指示灯符号片-DOWN	3SB6900-0NF	3SB69E12
 急停按钮标签, 60 mm, 印有 “EMERGENCY STOP” 字样		3SB6900-0GC	3SB69N6	指示灯符号片-OPEN	3SB6900-0NG	3SB69E13
 急停按钮标签, 90 mm, 印有 “EMERGENCY STOP” 字样		3SB6900-0GF	3SB69N9	指示灯符号片-CLOSE	3SB6900-0NH	3SB69E14
 标签框 铭文书写尺寸 25 × 10 mm		3SB6900-0HA	3SB69H10	指示灯符号片-RESET	3SB6900-0NJ	3SB69E15
 标签框 铭文书写尺寸 25 × 18 mm		3SB6900-0HB	3SB69H18	指示灯符号片-AUTO	3SB6900-0NK	3SB69E16
				指示灯符号片-O (标准符号)	3SB6900-0NL	3SB69E04
				指示灯符号片-I (标准符号)	3SB6900-0NM	3SB69E05
				指示灯符号片-II (标准符号)	3SB6900-0NN	3SB69E06
				指示灯符号片-→ (ISO 符号)	3SB6900-0NP	3SB69E03
				指示灯符号片-I (ISO 符号)	3SB6900-0NQ	3SB69E01
				指示灯符号片-O (ISO 符号)	3SB6900-0NR	3SB69E02

3SB6按钮指示灯产品快速选型代码简介

3 S B 6



常开触点数量：无触点：0
1NO：1
2NO：2

常闭触点数量：无触点：0
1NO：1

颜色：	绿色：G	钥匙拔出位置：	右边中间：RC
黑色：K	蓝色：B	左边：L	左边中间：LC
红色：R	白色：W	中间：C	任意位置：E
黄色：Y	红/绿：RG	右边：R	(注：颜色和钥匙拔出位置二选一)

电压：	AC/DC 24V：3	DC 220V：7
无电压：不标记	AC/DC 48V：4	AC 380V：8
AC/DC 6V：1	AC/DC 110V：5	125V AC/DC：9
AC/DC 12V：2	AC 220V：6	

是否带灯：

不带灯：无标记
带灯：D

按钮类别：

瞬动平头按钮：无标记
瞬动凸头按钮：H
自锁平头按钮：Z
自锁凸头按钮：HZ
蘑菇头按钮，30mm 瞬动：M3
蘑菇头按钮，40mm 瞬动：M
蘑菇头按钮，60mm 瞬动：M6
蘑菇头按钮，40mm 拉拔解锁：MZ
蘑菇头按钮，60mm 拉拔解锁：M6Z
Φ30mm急停按钮，旋转解锁：J3R
Φ30mm急停按钮，钥匙解锁：J3K
Φ40mm急停按钮，旋转解锁：JR
Φ40mm急停按钮，拉拔解锁：JL
Φ40mm急停按钮，钥匙解锁：JK
Φ40mm带触发功能急停按钮，旋转解锁：JAR
Φ40mm带触发功能急停按钮，拉拔解锁：JAL
Φ40mm带触发功能急停按钮，钥匙解锁：JAK

按钮类别：

选择按钮，短柄，两位置自锁，L-R：XZ
选择按钮，短柄，两位置瞬动，L<R：X
选择按钮，短柄，三位置自锁，L-C-R：X3Z
选择按钮，短柄，三位置瞬动，L>C<R：X3
选择按钮，短柄，三位置瞬动，L-C<R：X3R
选择按钮，短柄，三位置瞬动，L>C-R：X3L
选择按钮，长柄，两位置自锁，L-R：SZ
选择按钮，长柄，两位置瞬动，L<R：S
选择按钮，长柄，三位置自锁，L-C-R：S3Z
选择按钮，长柄，三位置瞬动，L>C<R：S3
选择按钮，长柄，三位置瞬动，L-C<R：S3R
选择按钮，长柄，三位置瞬动，L>C-R：S3L
钥匙操作按钮，两位置自锁，L-R，90°（10/14 点钟方向）：KZ
钥匙操作按钮，两位置瞬动，L<R，90°（10/14 点钟方向）：K
钥匙操作按钮，两位置瞬动，L<R，90°（9/12 点钟方向）：KA
钥匙操作按钮，三位置自锁，L-C-R：K3Z
钥匙操作按钮，三位置瞬动，L>C<R：K3
钥匙操作按钮，三位置，L-C<R：K3R
钥匙操作按钮，三位置，L>C-R：K3L
双位按钮，一个平钮一个高位钮：T

印字内容：

I：01；O：02；↑：03；
II：06；STOP：08；

按钮材料：

金属亮光：6
金属化：3

技术参数

符合标准	IEC60947 Part1, IEC60947 Part 5-1, IEC60947 Part 5-5 GB14048.5, GB14048.1, GB14048.14 ISO13850		
额定绝缘电压 U_i	AC 600 V, 50 Hz LED 模块: AC 440 V, 50 Hz; DC 250 V 指示灯: AC 440 V, 50 Hz; DC 250 V 紧凑型按钮: AC300V		
污染等级	3 级		
额定约定发热电流 I_{th} 模块式按钮 紧凑型按钮	10 A 5 A		
额定工作电压 U_e 和相应的额定工作电流 I_e (AC 50 ~ 60Hz)	模块化	紧凑型按钮	
U_e	$I_e/AC-12$	$I_e/AC-15$	$I_e/AC-15$
24 V	10 A	6 A	
110 V	10 A	6 A	
220 V/230 V	10 A	6 A	2 A
380/400/415 V	10 A	4 A	
	$I_e/DC-12$	$I_e/DC-13$	$I_e/DC-13$
24 V DC	10 A	6 A	1 A
48 V DC	8 A	4 A	
110 V DC	3.5 A	1.2 A	
220 V DC	1 A	0.4 A	
接触稳定性 试验电压/电流	17 V DC/5 mA, $\lambda < 10^{-6}$		
短路保护 快速熔断 延迟熔断	16 A 10 A		
机械寿命 • 按钮和触点模块 • 自锁型按钮 • 带灯按钮	300 万次 30 万次 300 万次		
电气寿命 • 开关元件带接触器 • 带有 AC-15 负载	300 万次 50 万次/ $I_e/AC-15$ (220 V/230 V)		
操作频率	1200 次/小时		
环境温度	工作状态: -25 °C ~ 70 °C 蜂鸣器工作状态: -25 °C ~ 55 °C 储藏运输状态: -40 °C ~ 80 °C		
防护等级 • 常规产品 (不包括以下类型) • 带防护盖的按钮、带灯按钮和指示灯 • 钥匙操作按钮 • 触点和 LED 模块 • 蜂鸣器	IP65 IP67 IP54 IP20 IP31		
导线截面尺寸 • 带端套的精细绞线 • 实心线 • 带端套实心线 • 带端套的精细绞线	2 × 0.5 ~ 1.5 mm ² 2 × 1 ~ 2.5 mm ² 2 × 0.5 ~ 0.75 mm ² 2 × 1 ~ 1.5 mm ² (指示灯)		
中座螺丝的紧固力矩	金属中座: 最大1Nm 塑料中座: 最大0.5Nm		
端子螺丝的紧固力矩	0.8 Nm ~ 1.2 Nm		
抗冲击等级, 根据 IEC 60068 2-27 部分 持续时间 最大加速度	11 ms 15 g		
抗振动等级, 根据 IEC 60068 2-6 部分 最大加速度 频率范围	5 g 10 ~ 500 Hz		
声音响度 (蜂鸣器) 闪光亮度 (蜂鸣器)	>=85dB(距头部10cm处) >=100cd/m ²		

安装结构及外形尺寸

安装结构

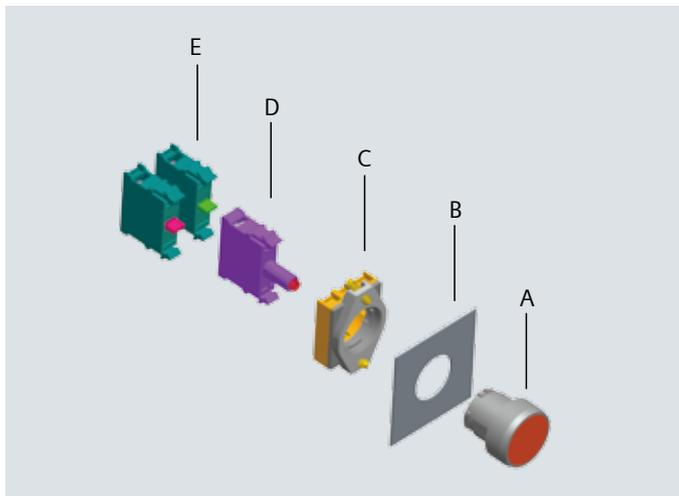

A 按钮头 B 面板 C 中座 D LED 模块 E 触点模块

外形尺寸

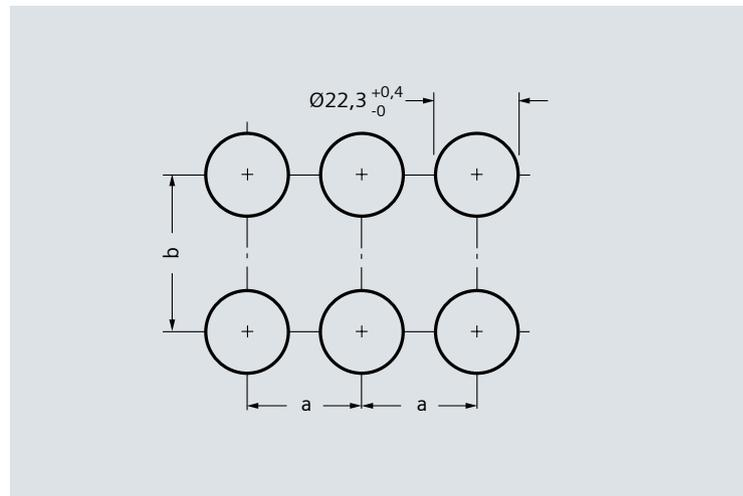

安装面板厚度：1 ~ 6 mm

安装有标签框和急停按钮标签的面板厚度：1 ~ 4mm

最小间距	a	b
急停按钮，蘑菇钮，长柄旋钮	42 mm*	50 mm*
其他按钮、指示灯	32 mm	50 mm

*： $\varnothing 60$ 蘑菇头按钮，最小水平间距为 62 mm，最小垂直间距为 62 mm

3SB6 外形尺寸图

平头按钮或带灯按钮，瞬动

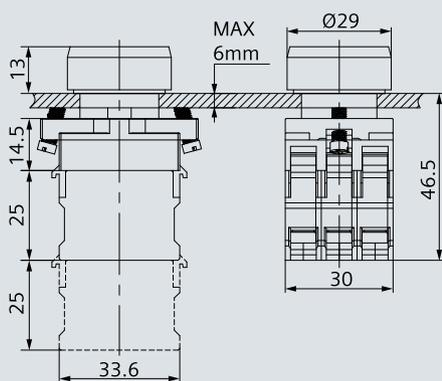

平头按钮，自锁

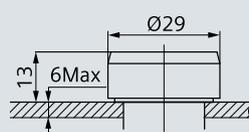

凸头按钮，自锁

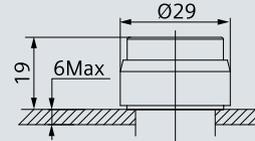

选择按钮

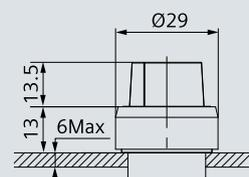

凸头按钮，瞬动

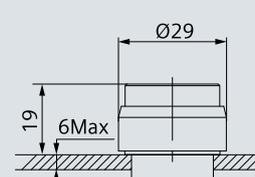

蘑菇头按钮 30 mm

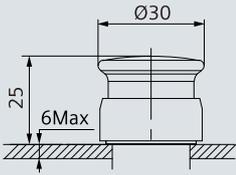

蘑菇头按钮 40 mm

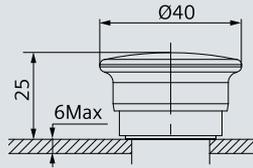

双位按钮

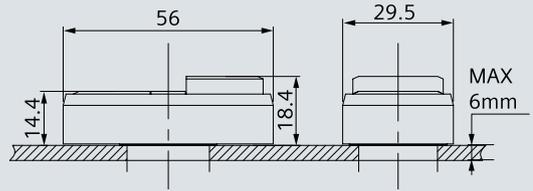

钥匙操作按钮

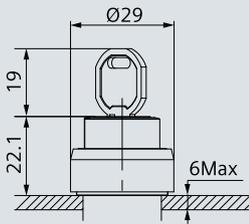

急停按钮旋转解锁

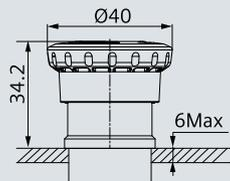

急停按钮拉拔解锁

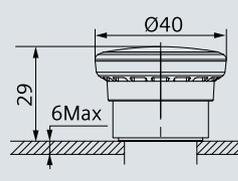

急停按钮钥匙解锁

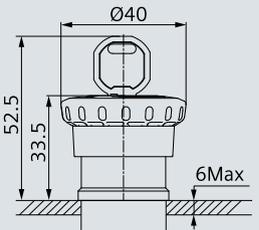

带触发功能的急停按钮，旋转解锁

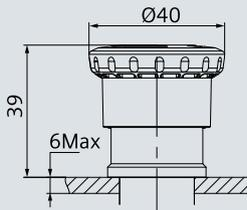

带触发功能的急停按钮，拉拔解锁

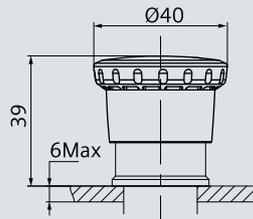

带触发功能的急停按钮，钥匙解锁

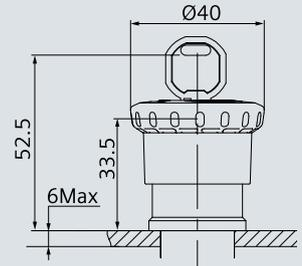

触点模块和 LED 模块

触点模块

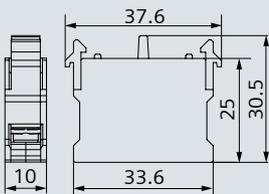

LED 模块

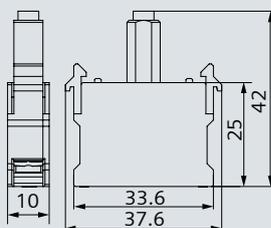

指示灯

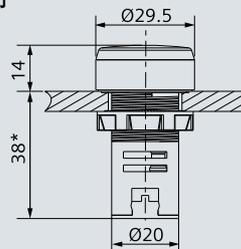

蜂鸣器

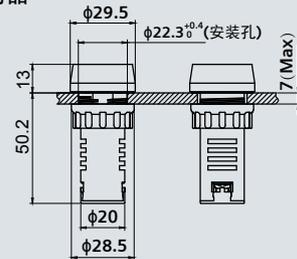

* 对于 220 V DC 指示灯此数据为 50 mm

紧凑型按钮

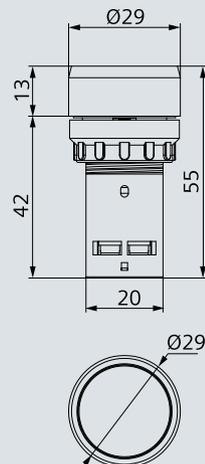

北方区

北京
北京市朝阳区望京中环南路7号
电话: 400 616 2020

包头
内蒙古自治区包头市昆区钢铁大街74号
财富中心1905室
电话: (0472) 520 8828

济南
山东省济南市舜耕路28号
舜耕山庄商务会所5层
电话: (0531) 8266 6088

青岛
山东省青岛市香港中路76号
颐中假日酒店4楼
电话: (0532) 8573 5888

烟台
山东省烟台市南大街9号
金都大厦16层1606室
电话: (0535) 212 1880

淄博
山东省淄博市张店区中心路177号
淄博饭店7层
电话: (0533) 218 7877

潍坊
山东省潍坊市奎文区四平路31号
鸢飞大酒店1507房间
电话: (0536) 822 1866

济宁
山东省济宁市市中区太白东路55号
万达写字楼1306室
电话: (0537) 316 6887

天津
天津市和平区南京路189号
津汇广场写字楼1401室
电话: (022) 8319 1666

唐山
河北省唐山市建设北路99号
火炬大厦1308室
电话: (0315) 317 9450/51

石家庄
河北省石家庄市中山东路303号
世贸广场酒店1309号
电话: (0311) 8669 5100

太原
山西省太原市府西街69号
国际贸易中心西塔16层1609B-1610室
电话: (0351) 868 9048

呼和浩特
内蒙古呼和浩特市乌兰察布西路
内蒙古饭店10层1022室
电话: (0471) 620 4133

东北区

沈阳
沈阳市沈河区青年大街1号市
府恒隆广场41层
电话: (024) 8251 8111

大连
辽宁省大连市高新园区
七贤岭广贤路117号
电话: (0411) 8369 9760

长春
吉林省长春市亚泰大街3218号
通钢国际大厦22层
电话: (0431) 8898 1100

哈尔滨
黑龙江省哈尔滨市南岗区红军街15号
奥威斯发展大厦30层A座
电话: (0451) 5300 9933

华西区
成都
四川省成都市高新区拓新东街81号
天府软件园C6栋1/2楼
电话: (028) 6238 7888

重庆
重庆市渝中区邹容路68号
大都会大厦18层1807-1811
电话: (023) 6382 8919

贵阳
贵州省贵阳市南明区花果山后街
彭家湾E7栋(国际金融中心1号)
14楼018.02室
电话: (0851) 8551 0310

昆明
云南昆明市北京路155号
红塔大厦1204室
电话: (0871) 6315 8080

西安
西安市高新区锦业一路11号
西安国家服务外包示范基地一区D座3层
电话: (029) 8831 9898

乌鲁木齐
新疆乌鲁木齐市五一一路160号
新疆鸿福大饭店贵宾楼918室
电话: (0991) 582 1122

银川
银川市北京东路123号
太阳神大酒店A区1507房间
电话: (0951) 786 9866

兰州
甘肃省兰州市东岗西路589号
锦江阳光酒店2206室
电话: (0931) 888 5151

华东区

上海
上海杨浦区大连路500号
西门子上海中心
电话: 400 616 2020

杭州
浙江省杭州市西湖区杭大路15号
嘉华国际商务中心1505室
电话: (0571) 8765 2999

宁波
浙江省宁波市江东区沧海路1926号
上东国际2号楼2511室
电话: (0574) 8785 5377

绍兴
浙江省绍兴市解放北路
玛格丽特商业中心西区2幢
玛格丽特酒店10层1020室
电话: (0575) 8820 1306

温州
浙江省温州市车站大道577号
财富中心1506室
电话: (0577) 8606 7091

南京
江苏省南京市中山路228号
地铁大厦17层
电话: (025) 8456 0550

扬州
江苏省扬州市文昌西路56号
公元国际大厦809室
电话: (0514) 8789 4566

扬中
江苏省扬中市前进北路52号
扬中宾馆明珠楼318室
电话: (0511) 8832 7566

徐州
江苏省徐州市泉山区中山北路29号
国贸大厦7A7室
电话: (0516) 8370 8388

苏州
江苏省苏州市新加坡工业园苏华路2号
国际大厦11层17-19单元
电话: (0512) 6288 8191

无锡
江苏省无锡市县前东街1号
金陵大酒店2401-2402室
电话: (0510) 8273 6868

南通
江苏省南通市崇川区桃园路8号
中南世纪城17栋1104室
电话: (0513) 8102 9880

常州

江苏省常州市关河东路38号
九洲寰宇大厦911室
电话: (0519) 8989 5801

盐城
江苏省盐城市盐都区
华邦国际大厦A区2008室
电话: (0515) 8836 2680

昆山
江苏省昆山市伟业路18号
昆山现代广场A座1019室
电话: (0512) 55118321

华南区
广州
广东省广州市天河路208号
天河城侧粤海天河城大厦8-10层
电话: (020) 3718 2222

佛山
广东省佛山市汾江中路121号
东建大厦19楼K单元
电话: (0757) 8232 6710

珠海
广东省珠海市香洲区梅华西路166号
西藏大厦1303A室。
电话: (0756) 335 6135

南宁
广西省南宁市金湖路63号
金源现代城9层935室
电话: (0771) 552 0700

深圳
广东省深圳市南山区华侨城
汉唐大厦9楼
电话: (0755) 2693 5188

东莞
广东省东莞市南城区宏远路1号
宏远大厦1510室
电话: (0769) 2240 9881

汕头
广东省汕头市金砂路96号
金海湾大酒店19楼1920室
电话: (0754) 8848 1196

海口
海南省海口市滨海大道69号
宝华海景大酒店803房
电话: (0898) 6678 8038

福州
福建省福州市五四路89号
置地广场11层04、05单元
电话: (0591) 8750 0888

厦门
福建省厦门市厦禾路189号
银行中心21层2111-2112室
电话: (0592) 268 5508

华中区

武汉
湖北省武汉市武昌区中南路99号
武汉保利大厦21楼2102室
电话: (027) 8548 6688

合肥
安徽省合肥市濉溪路278号
财富广场首座27层2701-2702室
电话: (0551) 6568 1299

宜昌
湖北省宜昌市东山大道95号
清江大厦2011室
电话: (0717) 631 9033

长沙
湖南省长沙市五一大道456号
亚太时代写字楼2101,2101-2室
电话: (0731) 8446 7770

南昌
江西省南昌市北京西路88号
江信国际大厦14楼1403/1405室
电话: (0791) 8630 4866

郑州
河南省郑州市中原区中原中路220号
裕达国贸中心写字楼2506房间
电话: (0371) 6771 9110

洛阳
河南省洛阳市涧西区西苑路6号
友谊宾馆516室
电话: (0379) 6468 3519

技术培训
北京: (010) 6476 8958
上海: (021) 6281 5933
广州: (020) 3718 2012
武汉: (027) 8773 6238/8773 6248-601
沈阳: (024) 8251 8220
重庆: (023) 6381 8887

技术支持与服务热线
电话: 400 810 4288
(010) 6471 9990
E-mail: 4008104288.cn@siemens.com
Web: www.4008104288.com.cn

**亚太技术支持(英文服务)
及软件授权维修热线**
电话: (010) 6475 7575
传真: (010) 6474 7474
Email: support.asia.automation@siemens.com

公司热线
北京: 400 616 2020

直接扫描
获得本书
PDF文件



扫描关注
西门子中国
官方微信



西门子(中国)有限公司
数字化工厂集团

如有变动,恕不事先通知
订货号: E20001-A0134-C200-V3-5D00
2017-SH905628-07173

西门子(中国)有限公司

本手册中提供的信息只是对产品的一般说明和特性介绍。文中内容可能与实际应用的情况有所出入,并且可能会随着产品的进一步开发而发生变化。仅当相关合同条款中有明确规定时,西门子方有责任提供文中所述的产品特性。

手册中涉及的所有名称可能是西门子公司或其供应商的商标或产品名称,如果第三方擅自使用,可能会侵犯所有者的权利。